

GF Aquasystem Transition Joint with Hexagonal Male Thread Green PP-R 25-3/4"

1148729

- Material: PP-R
- Color: Green
- Connection: Socket fusion

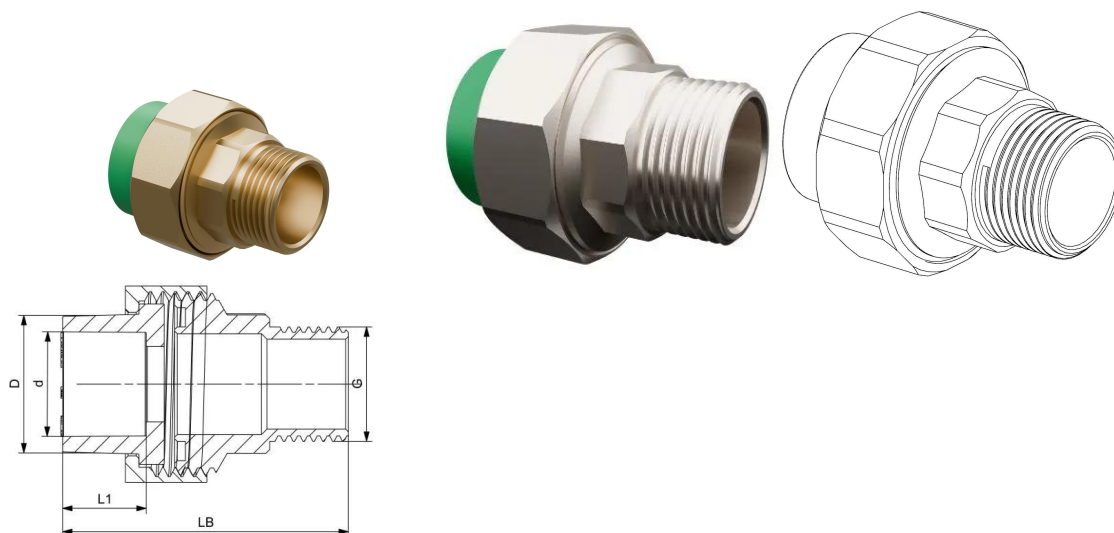

About GF Aquasystem Transition Joint with Hexagonal Male Thread Green PP-R

Specification

- AQUASYSTEM is one of the most reliable and high-quality PP-R systems on the market. It is ideal for transporting both hot and cold water in a variety of building systems as well as industrial and marine applications. The system features high temperature and pressure resistance while being hygienically safe and eligible for use in drinking water supply systems. Thanks to its chemical resistance behavior, the system is also a great choice for transferring or discharging chemical media.

Application

- Central heating systems
- Hot and cold water systems
- Drinking water and treated water supply systems
- Industrial Piping Systems (Transfer and discharge of chemicals)
- Air conditioner systems
- Solar Collectors

GF Aquasystem Transition Joint with Hexagonal Male Thread Green PP-R 25-3/4"

1148729

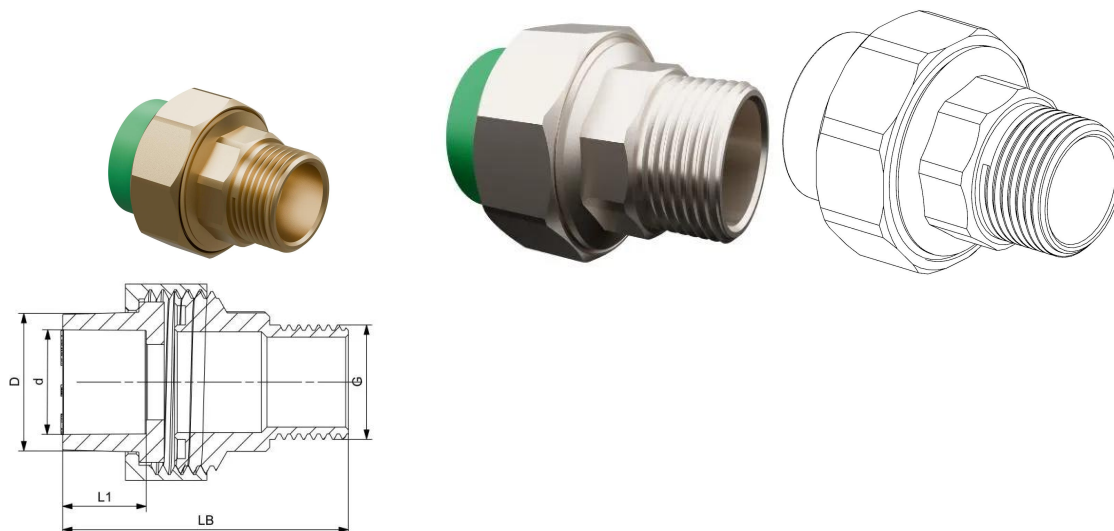

Product code

Item no EAN	8698652135175
Item no GF	4302702530121
Item no GTIN	08698652135175

Dimensions

Item Unit Height	60
Item Unit Length	45
Item Unit Weight	0,18
Item Unit Width	45
Item_UOM	pce

Measurements

Male_thread_R	3/4"
Z Measurement d	32,8
Z Measurement DD	33
Z Measurement L1	18,5
Z Measurement LB	59

Packaging

Packaging GTIN PL1	06414900095587
Packaging GTIN PL2	06414900277198
Packaging GTIN PL4	06414900277204
Packaging Height PL1	350

Packaging Height PL2	243
Packaging Height PL4	1200
Packaging Length PL1	300
Packaging Length PL2	415
Packaging Length PL4	1200
Packaging Quantity PL1	30
Packaging Quantity PL2	150
Packaging Quantity PL4	7200
Packaging Type PL1	Plastic_Bag
Packaging Type PL2	Medium_Box
Packaging Type PL4	Pallet
Packaging Volume PL1	0,004725
Packaging Volume PL2	0,02541294
Packaging Volume PL4	1,44
Packaging Weight PL1	5,4
Packaging Weight PL2	27,1
Packaging Weight PL4	1325,8
Packaging Width PL1	45
Packaging Width PL2	252
Packaging Width PL4	1000

Technical documents

Download documents here 

Uponor UK

Blackmor Lane The Pavillion
WD18 8GA, Watford
UK

T +44 (0)1923 381212
E
customerservice.uk.bfs@georgfi
scher.com