

Discover the wide range of our Flow Solutions for buildings

Catalogue 2026

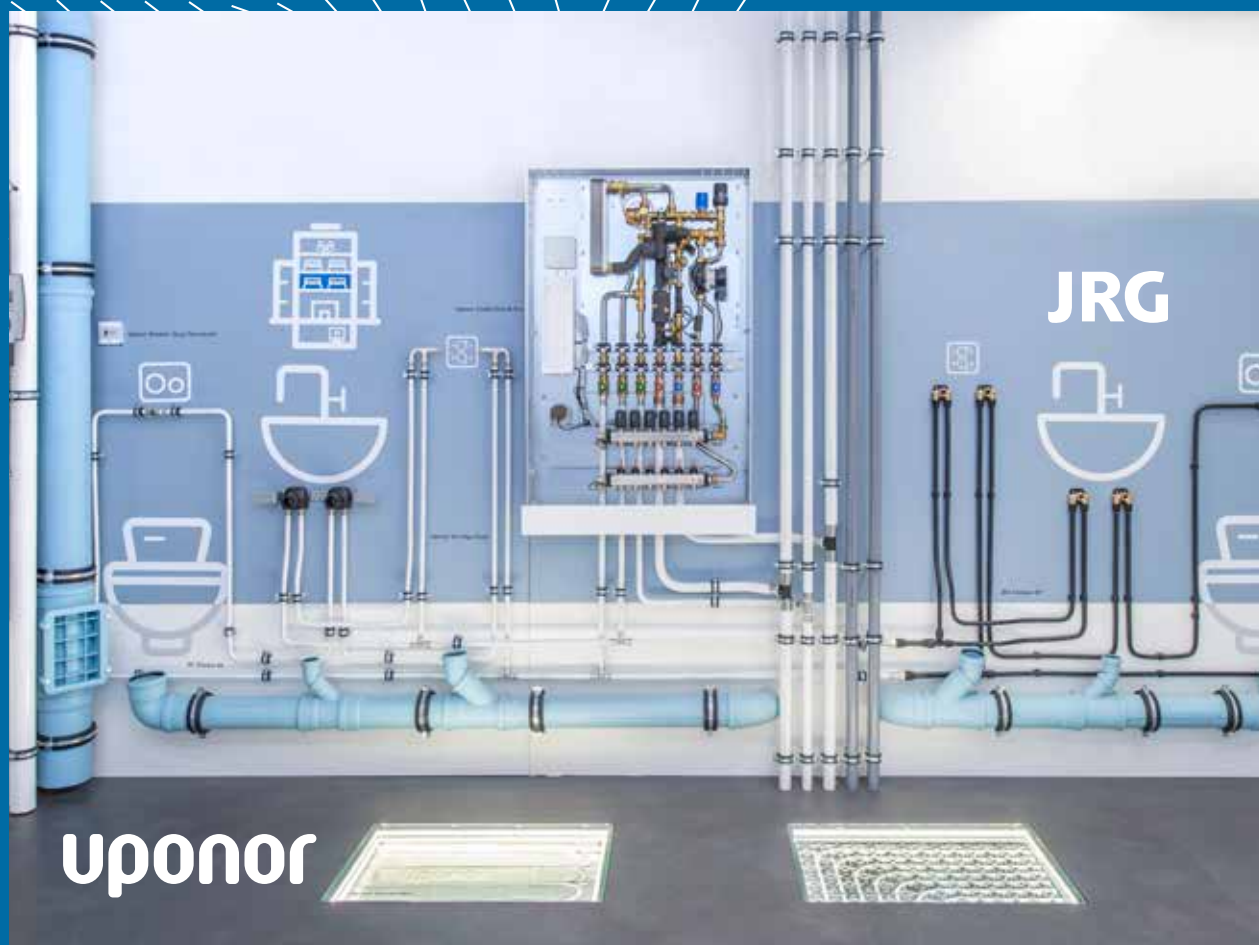

Building Flow Solutions for better buildings

By combining the best of the top technologies and expertise from the industry-leading brands GF, JRG, and Uponor, we offer a complete range of high-quality solutions. Built on trusted Swiss, Finnish, and German engineering, our systems address the full range of needs in modern buildings, from hygienic water distribution to energy-efficient heating and cooling. This reinforces GF's position as a global provider of sustainable, high-performance flow solutions for residential, commercial, and industrial buildings.

Excellence in Flow⁺

GF steps into the future

Our new brand claim "Excellence in Flow" captures who we are and what GF stands for – delivering superior customer value through a commitment to quality, innovation, and sustainability. This is how we shape the future of the Flow Solutions industry worldwide.

Change doesn't happen by chance – it's engineered. From water utilities and microelectronics to commercial buildings, multi residential homes or the marine industry, the demand for smarter, more efficient and sustainable flow solutions continues to grow.

With "Excellence in Flow", GF introduces a purpose-driven direction, rooted in over two centuries of engineering know-how and continuous innovation. Every solution we deliver – from the tiniest component to comprehensive solutions – is designed to ensure performance, precision, and superior value for our customers.

Purpose-driven innovation

GF focuses on solving real-world challenges across three business areas, Industry, Infrastructure, and Buildings, where efficient flow management is essential. From industrial flow processes and water management in urban areas to energy efficiency in buildings, every GF innovation helps customers meet today's evolving needs.

Rooted in heritage – built for the future

Since 1802, GF has built a legacy of industrial innovation and Swiss engineering. Now evolving into a global leader in Flow Solutions, the company delivers advanced technologies that support vital systems worldwide – driving sustainable, high-performance solutions engineered to meet the demands of a rapidly changing world.

The Plus that powers your progress



What we call the Plus Effect, is the visible result of our commitment to serve our customers: with a strong portfolio, prefab solutions, service concepts, trainings, partnerships, and much more to solve real-world challenges across three business areas - industry, infrastructure and buildings - to deliver Excellence in Flow.

Discover the Plus Effect
on our webpage now:

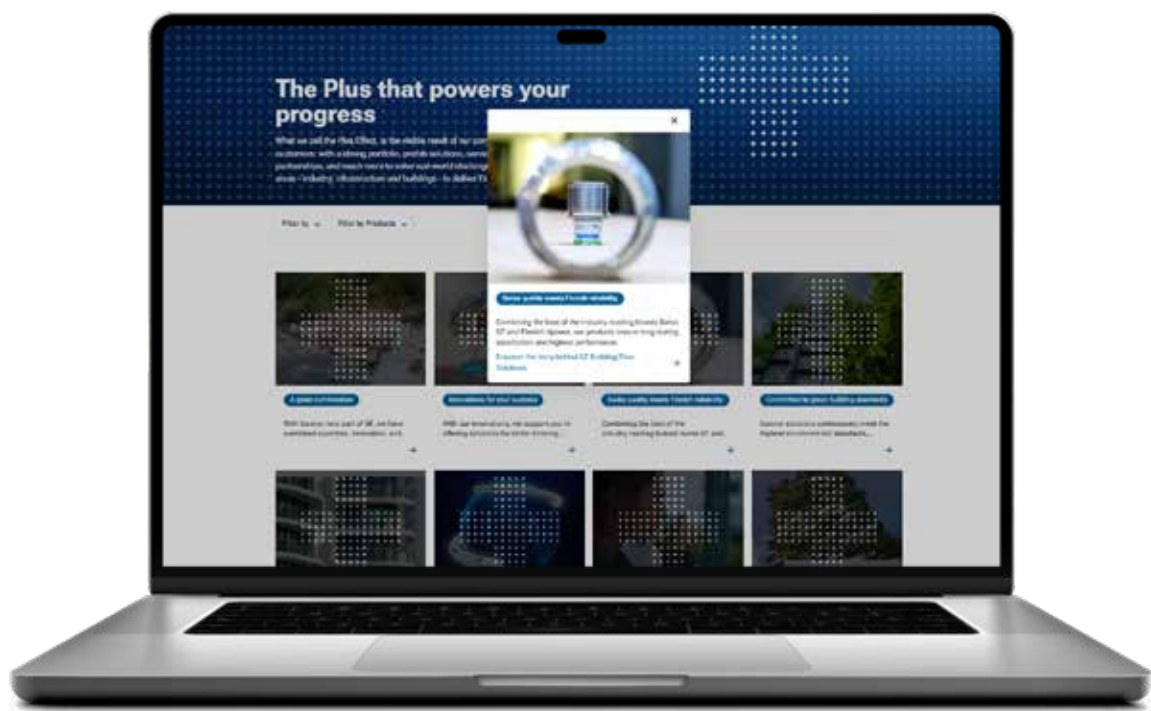

Full Solution Provider

Hot and Cold Water Supply



[Distribution Systems
12-32 mm](#)
[Risers Systems
32-315 mm](#)
[Accessories
& Tools](#)
[Services](#)

We offer one of the **widest range** of horizontally and vertically hot and cold-water distribution. With our world-renowned hot and cold-water distribution product lines we provide solutions across applications.

Highlight: Combined offering from GF and Uponor

Hot and Cold Water Controls



[Safety Valves](#)
[Shut-Off Valves](#)
[Control Valves](#)
[Digital Valves](#)

We offer **best-in-class** H&C water distribution with water control from one supplier. Our safe, hygienic and precise water controls are based on Swiss Quality.

Highlight: GF Hycleen Balance

Heating & Cooling Solutions



[Radiant Heating & Cooling](#)
[Heat Interface Units](#)
[Controls & Digital Services](#)
[Energy Distribution](#)

We offer heating and cooling solutions providing **maximum comfort while minimizing energy consumption**. Our heating & cooling solutions are for all buildings types and based on a long product brand heritage.

Highlight: Ecoflex VIP

Waste Water Systems



[Acoustic House Drainage](#)
[Standard House Drainage](#)
[Drain Inlet](#)
[Air-Admittance Valves](#)

We offer **complete acoustic and standard solutions** for wastewater and in-house drainage for all building types. Our wastewater and drainage solutions feature quality, fire resistance and noise reduction.

Highlight: GF Silenta

Multipurpose Applications



[Malleable Cast Iron Fittings](#)
[PRIMOFIT HYCON](#)
[PRIMOFIT Compression Fittings](#)
[Fire Suppression](#)

We offer proven and versatile fittings and applications that enable **hassle-free installations**. Our quick and easy solutions are tailored to address different needs and combine durability with simplicity.

Highlight: Malleable Iron

Speed Up Your Construction

Faster renovation, smarter modernization with Uponor Siccus 16 and Uponor Siccus Mini

Renovations don't have to mean long construction times and dusty workspaces. Be it a single room upgrade or a full home transformation, our Uponor Siccus systems are designed for faster, cleaner, and smarter renovations.

With ultra-low installation heights, one-person dry installation, and immediate flooring options, both Uponor Siccus 16 and Uponor Siccus Mini ensure maximum efficiency and comfort - for satisfied customers throughout the project.

Renovations without limitations in floors, ceilings, and walls: Uponor Siccus 16



When time, height, and weight constraints make traditional underfloor heating difficult, Uponor Siccus 16 delivers. At just 20 mm, this lightweight system allows **direct flooring on the EPS panel**, eliminating multiple steps and cutting installation time by up to 40%. With a fast heat-up time of just 20 minutes, Uponor Siccus 16 makes energy-efficient underfloor heating possible even in projects with strict floor load or space restrictions.

- **Low installation height of 20 mm**
- **Up to 40% faster installation by removing extra layers**
- **Fast heat-up time: only 20 minutes**
- **Lightweight design for floor load restrictions**

Ultra-thin, ultra-fast, and built for renovation: Uponor Siccus Mini

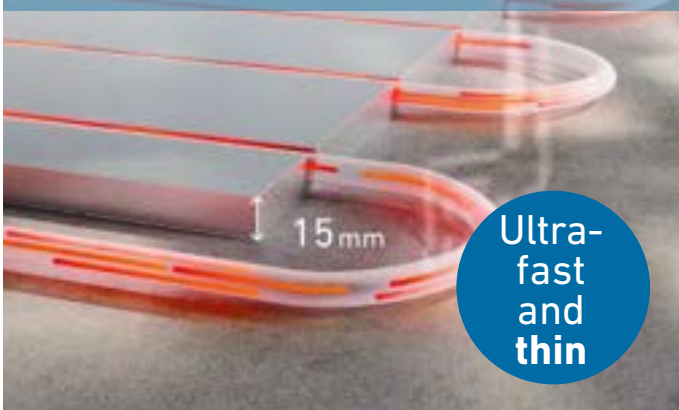

When every millimetre matters, Uponor Siccus Mini steps in. At just 15 mm, it's as thin as a pound coin, making it perfect for older buildings and tight renovation projects. Its **Direct Flooring Technology** and **one-step installation** achieve 90% performance in under an hour, with 34% more heating capacity than standard dry systems.

- **Only 15 mm thin: tailor-made for low-height renovations**
- **90% performance in under 1 hour**
- **34% more heating capacity than standard dry systems**

Efficiency at Scale

With Uponor Ecoflex VIP 2.0 - Now available in 140 mm



Introducing the next-generation flexible pre-insulated pipe system for modern local and district heating. By pairing Vacuum Insulated Panel (VIP) technology with a slimmer jacket, the new generation of Uponor Ecoflex VIP pipes delivers a lambda of 0.004 W/mK and achieves up to 60% less heat loss and up to 70% smaller jacket size (vs. PE insulation with comparable performance).

As cities and housing developments scale district heating, planners need high performance without installation headaches. Uponor Ecoflex VIP 2.0 answers that with a compact, flexible system for long-life, low-temperature networks: the Uponor Ecoflex VIP Thermo in 140 mm dimension adds high capacity for large projects;

- with up to 1,500 kW at ΔT 20 K (\approx 200 flats) while staying easy to coil, handle, and install;
- up to 20% faster than stiff pre-insulated pipes and up to 50% vs. steel, with longer coil lengths and fewer joints.

Fully compatible with existing Ecoflex fittings and accessories, Uponor Ecoflex VIP 2.0 helps you scale networks quickly, efficiently, and confidently.

Press with the Best

With Uponor S-Press Plus and Uni Pipe



Uponor S-Press PLUS: Smarter, Faster, Stronger

Experience the next level of reliability and efficiency with Uponor S-Press PLUS. Built to resist dezincification, crack corrosion, and harsh concrete chemicals, its reinforced design handles heavy mechanical loads with ease.

Key benefits:

- Instant safety checks: Visual press indicator, leak-before-press function, and precise U-profile jaws ensure every connection is secure.
- Faster installation: Simply cut, insert, and press—no bevelling or calibration needed. Save up to 25% time vs. radial systems and 50% vs. axial/cone-grip fittings.
- Superior performance: Up to 60% better flow, 100% backward compatibility with existing Uponor pipes and jaws, and quick access to tutorials via QR code.
- Enhanced flexibility: Combine with Uni Pipe for up to 40% tighter bends, 0% readjustment, and 15% fewer fittings needed.
- Uponor S-Press PLUS — engineered for precision, speed, and long-lasting performance.

Waste Water Systems

Silence where it Matters

With GF Silenta Acoustic System



We deliver complete wastewater and in-house drainage systems for every building type. Our portfolio pairs quality, fire resistance, and proven noise reduction with design freedom: noise-reducing options for perfect acoustic comfort, drain inlets in multiple sizes, and air-admittance valves that keep odors out.

With GF Silenta, we bring acoustic performance, durability, and reliability together so wastewater flow doesn't disrupt comfort in busy buildings. By combining robust materials with proven noise-reducing design, GF Silenta helps create quieter living and working spaces without compromising performance. Precision-engineered pipes and fittings support fast, confident installation and long-term quality in every connection, delivering quicker installation and fewer service calls. Designed for both residential and commercial projects, GF Silenta pairs dependable noise control with fire-resistant solutions for apartments, hotels, hospitals, offices, and more.

Reference Cases

The World with GF Building Flow Solutions

Our track record of success is highlighted by numerous high-profile projects across various sectors, from residential to commercial, from single homes to multi-purpose complexes, from office buildings to industry sites. These four projects represent only a small part of our wide range of applications.

Discover more:



Apartment Renovation, Amsterdam, Netherlands



Old walls, new comfort: With Uponor Siccus 16

Marinde and Rens live with their dog, Juca, in a charming 1915 apartment overlooking the Plantage Muidergracht canal in Amsterdam. The building's original timber floors can't support much additional weight—especially not from traditional wet heating systems—and allows only limited space for insulation or heating components. In fact, there's just 20 mm between the subfloor and the tiles.

While searching for a suitable radiant heating solution for their kitchen, Marinde turned to an AI search engine—and was pleasantly surprised when it recommended the perfect match: Uponor Siccus 16.

Located on the second floor of a listed five-storey building, the apartment's kitchen renovation included removing the old radiator. This is exactly where Uponor Siccus 16 excels: the panel is only 20 mm thick, ultra-lightweight, comes with built-in insulation, and can be tiled directly thanks to its exceptional compressive strength.

Hotel Restaurant Sonne, Sissach, Switzerland



Intelligent water control: With Hyclean Automation System

The Hotel Sonne in Sissach, Switzerland, has a 500-year-old tradition. Based on its historic structure combined with a modern infrastructure, the new owners developed a versatile concept. Restaurants with traditional-modern cuisine, a hotel with 19 individually designed guest rooms, a retirement home, and medical center radiate the charm of the unique ambience.

A cutting edge, safe drinking water installation was especially close to the hearts of the new owners. Therefore the Hyclean Automation System from GF was the first choice. 15 circulation valves and one flush valve have been installed and can be controlled safely and conveniently via the System master. The Hyclean Connect cloud solution allows the installation to be monitored and controlled digitally. Pipes not in constant use are automatically flushed every 72 hours to prevent water from stagnating. The circulation valves are responsible for ensuring constant temperatures and automatic hydraulic balancing.

Global Reach, Local Expertise

Connect with our team in the United Kingdom.



Services and Facilities

We offer additional resources to ensure your project runs seamlessly and our specialist team are on hand from the start of the project through to completion.

We can provide:

- + Design and estimation services with material lists and quotes
- + Feasibility analysis to ensure the best use of our system for your project
- + Prototype installations for client approval
- + Free on-site certificated training with regular follow-up session
- + Observation reports and installation quality checks
- + Access to our BIM libraries
- + Technical documentation for all key products

Plumbing Solutions for the Construction Industry



Hot and Cold Water Supply

Uni-Pipe Plus

the world's first Seamless Aluminium Composite Pipe - SACP



At GF we strive to provide innovation which raises the standard for the quality and performance of plumbing installations. Uponor's Uni-Pipe PLUS uses ground breaking technology to enhance the benefits of using multilayer pipe systems. More flexible, easier to use and even more reliable, the new pipes offer the designer and installer market leading performance whilst retaining all the benefits of a traditional MLCP.

Compatible with all Uponor press systems.

Reliable and safe for more than 30 years

Uni Pipe PLUS



Uni Pipe PLUS is ideal for delivering hygienic hot and cold drinking water, heating or chilled water systems, and hydronic radiant heating or cooling.

Compatible for use with a wide variety of fittings from the S-Press PLUS range in either DZR Brass or PPSU.

Our range features many adapters for connections to all materials such as copper and stainless steel, whilst special compression adapters make easy and secure connections to Uponor manifolds and standard BS EN 1254-2 compression type fittings.

Specification

Uponor Uni Pipe PLUS Seamless Aluminium Composite (SAC).

PE-RT/AL/PE-RT - 5 layer composite pipe consisting of an Aluminium pipe (100% oxygen-proof diffusion barrier, exceeding the requirements of DIN 4726), bonded to an inner layer of PE-RT (Polyethylene Raised Temperature), and outer layer of white PE-RT (Polyethylene Raised Temperature)

- Manufactured to BS EN ISO 21003-1 2008.
- Pipes are marked at 1m intervals with full production data in accordance with the requirements of the standard.
- Sizes 14-32 mm supplied as flexible coils
- Sizes 16-32 mm as extra rigid straight lengths.

Benefits

- Seamless or OWC-technology for highest level of safety
- High dimensional stability, low expansion rates
- Flame-free installation
- No risk of theft
- Increased flexibility
- 100% oxygen barrier
- Lightweight

Application

Tested/approved according to BS EN ISO 21003 Multilayer piping systems for hot and cold water installations inside buildings for application class 1,2,4,5/10bar

Domestic water services: The permanent operating temperature from 20°C to 70°C at a maximum permanent operating pressure of 10 bar. The short-term malfunction temperature is 95°C for a period of 100 hours in the operating life time.

Domestic cold water services : where the water temperature does not exceed 20°C at a maximum permanent operating pressure of 16bar.

Heating: The permanent operating temperature ranges up to 80°C at a maximum permanent operating pressure of 10 bar. The short-term malfunction temperature is 100°C for a period of 100 hours in the operating life time.

Certification

UK Reg4 approval

- WRAS or
- KIWA

To meet the requirements of the Water Supply (Water Fittings) Regulations 1999

Uni Pipe PLUS

Uponor Uni Pipe PLUS white S

- Bar
- High dimensional stability, low expansion rate
- A stiffer construction than a coiled pipe
- 100% Oxygen barrier

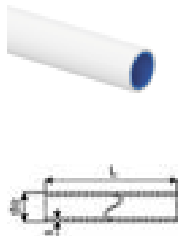

Item No.	Dimensions	do mm	s mm	Pallet/ Pack	Box/M QTY	UOM	Price per m/each
1060783	16x2,0 3m	16	2	75	3	m	4,28
1059572	16x2,0 5m	16	2,0	125	5	m	4,28
1060784	20x2,25 3m	20	2,25	51	3	m	7,10
1059573	20x2,25 5m	20	2,25	85	5	m	7,10
1060785	25x2,5 3m	25	2,5	30	3	m	10,96
1059574	25x2,5 5m	25	2,5	50	5	m	10,96
1060786	32x3,0 3m	32	3	21	3	m	13,82
1059575	32x3,0 5m	32	3	35	5	m	13,72

Uponor Uni Pipe PLUS white

- Coil
- High dimensional stability, low expansion rates
- Increased flexibility
- 100% oxygen barrier

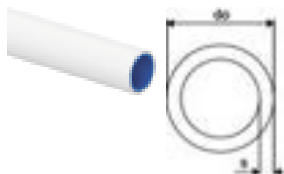

Item No.	Dimensions	do mm	s mm	Pallet/ Pack	Box/M QTY	UOM	Price per m/each
1013366	14x2,0 200m	14	2	2600	200	m	3,06
1096008	16x2,0 50m	16	2,0	1000	50	m	3,31
1059576	16x2,0 100m	16	2,0	2000	100	m	3,22
1092653	16x2,0 120m	16	2	2400	120	m	3,33
1059577	16x2,0 200m	16	2	2600	200	m	3,22
1059578	16x2,0 500m	16	2,0	3500	500	m	3,22
1059579	20x2,25 100m	20	2,25	1300	100	m	5,76
1059581	25x2,5 50m	25	2,5	700	50	m	9,68
1059583	32x3,0 50m	32	3	400	50	m	13,72

Uponor Uni Pipe PLUS white insulated S6 WLS 035

- Coil
- Insulation thickness 6 mm
- Thermal conductivity $\lambda=0,035$ W/m*k
- Round extruded
- Fire Class E to BS EN 13501-1

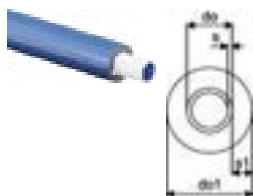

Item No.	Dimensions	do mm	di mm	s mm	s1 mm	Pallet/ Pack	Box/M QTY	UOM	Price per m/each
1063556	16x2,0 blue 75m	16	28	2	6	600	75	m	6,80
1063557	20x2,25 blue 75m	20	32	2,25	6	600	75	m	9,14
1063558	25x2,5 blue 50m	25	37	2,5	6	400	50	m	11,97

Uni Pipe PLUS

Uponor Uni Pipe PLUS white insulated S6

- Coil
- Insulation thickness 6 mm
- Thermal conductivity $\lambda=0,040$ W/m*k
- Round extruded
- Fire Class E to BS EN 13501-1

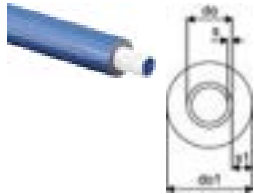

Item No.	Dimensions	do mm	s mm	s1 mm	Pallet/ Pack	Box/M QTY	UOM	Price per m/each
1013577	14x2,0 red 50m	14	2	6	600	50	m	6,46

Uponor Uni Pipe PLUS white insulated S10 WLS 035

- Coil
- Insulation thickness 10 mm
- Thermal conductivity $\lambda=0,035$ W/m*k
- Round extruded
- Fire Class E to BS EN 13501-1

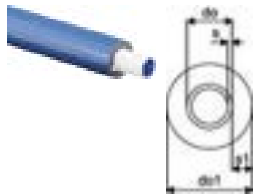

Item No.	In/Out	Dimensions	do mm	do1 mm	s mm	s1 mm	Pallet/ Pack	Box/M QTY	UOM	Price per m/each
1160885	01.25	14x2,0 blue 75m	14	34	2	10	450	75	m	7,28
1062181		16x2,0 blue 75m	16	36	2	10	450	75	m	7,17
1062182		20x2,25 blue 75m	20	40	2,25	10	525	75	m	10,07
1062183		25x2,5 blue 50m	25	45	2,5	10	350	50	m	13,01

Uponor UNI PIPE PLUS white in conduit

- Coil
- Pipe in conduit

- Uponor Uni-Pipe PLUS 'Pipe-in-Conduit' should be used in solid foors to comply with the Water Regulations (water fittings) 1999. No ducting is necessary, and pipes can subsequently be withdrawn and replaced if required. Uponor Multilayer pipes are not affected by standard concrete or screeds.

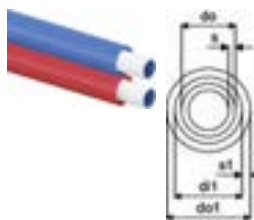

Item No.	Dimensions	di1 mm	do mm	do1 mm	s mm	s1 mm	Pallet/ Pack	Box/M QTY	UOM	Price per m/each
1013678	14x2,0 - 25/20 red 75m	20	14	25	2		1125	75	m	6,28
1063061	16x2,0 - 25/20 red 75m	20	16	25	2	2,5	1125	75	m	7,22
1063059	16x2,0 - 25/20 blue 75m	20	16	25	2,3	2,5	1125	75	m	7,10
1063062	20x2,25 - 28/23 red 75m	23	20	28	2,3	2,5	900	75	m	10,84
1063060	20x2,25 - 28/23 blue 75m	23	20	28	2,3	2,5	900	75	m	10,84

Uni Pipe PLUS

Uponor Uni Pipe PLUS clip single

- Easy to open clip
- Clips can be assembled in series
- Fixing using screws - max. diameter 5mm



Item No.	Dimensions	di mm	l mm	b mm	h mm	Pallet/ Pack	Box/M QTY	UOM	Price per m/each
1135502	16	16	40	18	47	1350	50	pce	1,13
1135503	20	20	46	18	59	900	50	pce	1,44
1135504	25	25	50	18	68	400	50	pce	1,83
1135505	32	32	58	18	79	400	50	pce	3,05
1135506	40	40	70	17	100	320	40	pce	2,92
1135507	50	50	80	17	116	200	25	pce	3,23

Uponor Uni Pipe PLUS clip double

- Easy to open clip
- Clips can be assembled in series
- Fixing using screws - max. diameter 5mm

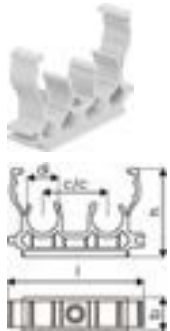

Item No.	Dimensions	c/c mm	di mm	l mm	b mm	h mm	Pallet/ Pack	Box/M QTY	UOM	Price per m/each
1135508	16	34	16	72	18	47	720	40	pce	1,42
1135509	20	41	20	86	18	59	320	40	pce	1,67
1135510	25	47	25	96	18	68	320	40	pce	2,00

MLC



MLC Multilayer is ideal for delivering hygienic hot and cold drinking water, for heating or chilled water systems, and hydronic radiant heating or cooling.

Compatible for use with a wide variety of fittings from the S-Press and S-Press PLUS ranges, in either DZR Brass or PPSU.

Our range features many adapters for connections to all materials such as copper and stainless steel, whilst special compression adapters make easy and secure connections to Uponor manifolds and standard BS EN 1254-2 compression type fittings.

Specification

Uponor MLC (Multi Layer Composite).

- PE-RT/AL/PE-RT - 5 layer composite pipe consisting of an Aluminium pipe, bonded to an inner layer of Polyethylene Raised Temperature (PE-RT), and an outer layer of white Polyethylene Raised Temperature (PE-RT).
- 100% oxygen-proof diffusion barrier, exceeding the requirements of DIN 4726
- Manufactured to BS EN ISO 21003-1 2008.
- Pipes are marked at 1m intervals with full production data, in accordance with the requirements of the standard.
- Sizes 12 - 32mm supplied as flexible coils, or 40-110mm as extra rigid straight lengths.

Uponor MLC white

- Coil
- High dimensional stability, low expansion rates
- Increased flexibility
- 100% oxygen barrier



Item No.	In/Out	Dimensions	do	s	Pallet/ Pack	Box/M QTY	UOM	Price per m/each	
1013575	12.26	12x1,6	100m	12	1,6	2000	100	m	3,38

Benefits

- OWC-technology for highest level of safety
- High dimensional stability, low expansion rates
- Flame-free installation
- No risk of theft
- Increased flexibility
- 100% oxygen barrier
- Lightweight

Application

Tested/approved according to BS EN ISO 21003 Multilayer piping systems for hot and cold water installations inside buildings for application class 1,2,4,5/10bar

Domestic water services: The permanent operating temperature from 20°C to 70°C at a maximum permanent operating pressure of 10 bar. The short-term malfunction temperature is 95°C for a period of 100 hours in the operating life time.

Domestic cold water services : where the water temperature does not exceed 20°C at a maximum permanent operating pressure of 16bar.

Heating: The permanent operating temperature ranges up to 80°C at a maximum permanent operating pressure of 10 bar. The short-term malfunction temperature is 100°C for a period of 100 hours in the operating life time.

Certification

UK Reg4 approval

- WRAS or
- KIWA

To meet the requirements of the Water Supply (Water Fittings) Regulations 1999

Uponor MLC white S

- Bar
- High dimensional stability, low expansion rate
- A stiffer construction than a coiled pipe
- 100% Oxygen barrier



Item No.	Dimensions	do mm	s mm	Pallet/ Pack	Box/M QTY	UOM	Price per m/each
1013446	40x4,0 5m	40	4	20	5	m	22,93
1013449	50x4,5 5m	50	4,5	20	5	m	34,20
1013451	63x6,0 5m	63	6	15	5	m	42,29
1013453	75x7,5 5m	75	7,5	255	5	m	66,20
1013455	90x8,5 5m	90	8,5	255	5	m	97,87
1013457	110x10,0 5m	110	10	165	5	m	138,11

Uponor MLC white insulated S13 BL-S2-D0

- Coil
- Pre-insulated, with foil vapour barrier
- Fire class BL- s1, d0 to BS EN 13501-1 (Insulation - foam & vapour barrier)

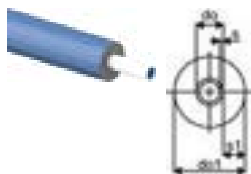

Item No.	Dimensions	do mm	s mm	Pallet/ Pack	Box/M QTY	UOM	Price per m/each
1093952	16x2 blue 75m	16	2	450	75	m	7,97
1093953	16x2 red 75m	16	2	450	75	m	7,75
1093954	20x2,25 blue 75m	20	2,25	450	75	m	10,73
1093955	20x2,25 red 75m	20	2,25	450	75	m	10,73
1094883	25x2,5 blue 50m	25	2,5	200	50	m	13,01

S-Press PLUS



S-Press PLUS/ S-Press, our new generation of press fittings, are the perfect solution for ensuring permanently tight pipe connections.

S-Press PLUS fittings are 100% backward compatible with all previous Uponor composite pipes and tools. Available in dimensions from 14 to 75 mm in both metal and plastic, S-Press PLUS are the fittings that know no compromise.

Specification

- Unique press indicator foil
- Fast 3-step installation (press without bevel)
- Innovative QR code for immediate digital access
- Colour coded
- Fixed press sleeve with inspection windows
- Precise jaw location
- Fast diameter recognition
- Accurate test safety function
- 100% backward compatible with existing Uponor components
- Flow rate optimized fitting body

Uponor S-Press PLUS elbow PPSU

- Material: PPSU



Item No.	Dimensions	l1 mm	l2 mm	z1 mm	z2 mm	Pallet/ Pack	Box/M QTY	UOM	Price per m/each
1039929	16-16	33	33	13,1	13,1	80	20	pce	6,87
1039930	20-20	37	37	15,7	15,7	80	10	pce	8,56
1039931	25-25	47,5	47,5	19,2	19,2	80	10	pce	12,44
1039932	32-32	51	51	23,2	23,2	20	5	pce	19,29

Benefits

- TOUGH: Withstand harshest conditions
- SAFE: Ensuring your perfect pressing result
- EASY: Simplifying planning and installation
- SMART: Answering all your questions on site

Application

Tested/approved according to BS EN ISO 21003 Multilayer piping systems for hot and cold water installations inside buildings for application class 1,2,4,5/10bar

Domestic water services: The permanent operating temperature from 20°C to 70°C at a maximum permanent operating pressure of 10 bar. The short-term malfunction temperature is 95°C for a period of 100 hours in the operating life time.

Domestic cold water services : where the water temperature does not exceed 20°C at a maximum permanent operating pressure of 16bar.

Heating: The permanent operating temperature ranges up to 80°C at a maximum permanent operating pressure of 10 bar. The short-term malfunction temperature is 100°C for a period of 100 hours in the operating life time.

Certification

UK Reg4 approval

- WRAS or

- KIWA

to meet the requirements of the Water Supply (Water Fittings) Regulations 1999

S-Press PLUS

Uponor S-Press PLUS coupling PPSU

- Material: PPSU

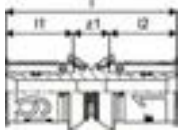

Item No.	Dimensions	l1 mm	l2 mm	l mm	z1 mm	Pallet/ Pack	Box/M QTY	UOM	Price per m/each
1039933	16-16	19,9	19,9	50,5	10,7	80	20	pce	5,47
1039934	20-20	21,3	21,3	54	11,4	80	10	pce	7,22
1039935	25-25	28,3	28,3	68	11,4	80	10	pce	11,53
1039936	32-32	27,8	27,8	69	13,4	80	10	pce	18,83

Uponor S-Press PLUS reducer PPSU

- Material: PPSU

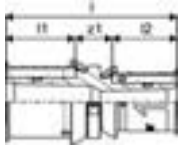

Item No.	Dimensions	l1 mm	l2 mm	l mm	z1 mm	Pallet/ Pack	Box/M QTY	UOM	Price per m/each
1039937	20-16	21,3	19,9	52,5	11,3	80	20	pce	6,68
1039938	25-16	28,3	19,9	59,5	11,3	80	10	pce	10,51
1039939	25-20	28,3	21,3	61	11,4	80	10	pce	11,04
1039940	32-25	27,8	28,3	69	12,9	80	10	pce	18,04

Uponor S-Press PLUS tee PPSU

- Material: PPSU

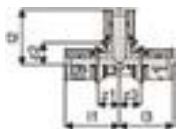

Item No.	Dimensions	l1 mm	l2 mm	l3 mm	z1 mm	z2 mm	z3 mm	Pallet/ Pack	Box/M QTY	UOM	Price per m/each
1039944	16-16-16	33	33	33	13,1	13,1	13,1	80	10	pce	9,14
1039945	20-20-20	37	37	37	15,7	15,7	15,7	80	10	pce	13,70
1039946	25-25-25	47,5	47,5	47,5	19,2	19,2	19,2	20	5	pce	23,77
1039947	32-32-32	51	51	51	23,2	23,2	23,2	20	5	pce	37,77

S-Press PLUS

Uponor S-Press PLUS tee reducer PPSU

- Fixed stainless steel sleeve

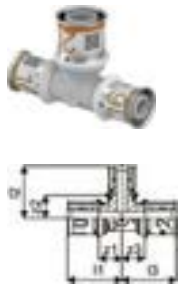

Item No.	Dimensions	l1 mm	l2 mm	l3 mm	z1 mm	z2 mm	z3 mm	Pallet/ Pack	Box/M QTY	UOM	Price per m/each
1039948	16-20-16	35	34,5	35	15,1	13,2	15,1	80	10	pce	12,92
1039949	20-16-16	37	35,5	35,5	15,7	15,6	15,6	80	10	pce	12,92
1039950	20-16-20	37	35,5	37	15,7	15,6	15,7	80	10	pce	12,92
1039951	20-20-16	37	37	35,5	15,7	15,7	15,6	80	10	pce	12,92
1039952	20-25-20	40,5	47,5	40,5	19,2	19,2	19,2	80	10	pce	22,44
1039953	25-16-16	47,5	39	39	19,2	19,1	19,1	80	10	pce	15,95
1039954	25-16-20	47,5	39	40,5	19,2	19,1	19,2	80	10	pce	19,69
1039955	25-16-25	47,5	39	47,5	19,2	19,1	19,2	80	10	pce	18,07
1039956	25-20-20	47,5	40,5	40,5	19,2	19,2	19,2	80	10	pce	16,82
1039957	25-20-25	47,5	40,5	47,5	19,2	19,2	19,2	80	10	pce	21,20
1039958	32-16-32	51	42,5	51	23,2	22,6	23,2	20	5	pce	27,57
1039959	32-20-32	51	44	51	23,2	22,7	23,2	20	5	pce	33,46
1039960	32-25-25	51	51	51	23,2	22,7	22,7	20	5	pce	33,62
1039961	32-25-32	51	51	51	23,2	22,7	23,2	20	5	pce	34,12

Uponor S-Press PLUS adapter male thread

- Made of tin-plated DZR brass



Item No.	Dimensions	l1 mm	l2 mm	l mm	R inch	z1 mm	Pallet/ Pack	Box/M QTY	UOM	Price per m/each
1070501	16-R3/8"MT	10,7	19,8	40,5	3/8	10	80	20	pce	6,45
1070502	16-R1/2"MT	14	19,8	43,5	1/2	9,7	80	20	pce	7,54
1070503	16-R3/4"MT	15,5	19,8	46	3/4	10,7	120	15	pce	9,19
1070504	20-R1/2"MT	14	21,3	45	1/2	9,7	80	20	pce	10,05
1070505	20-R3/4"MT	14,5	21,3	47,5	3/4	11,2	80	10	pce	11,35
1070506	20-R1"MT	14,5	21,3	50,5	1	14,7	80	10	pce	16,61
1070507	25-R3/4"MT	15	28,3	54,5	3/4	11,2	80	10	pce	14,64
1070508	25-R1"MT	14,5	28,3	57,5	1	14,5	40	5	pce	19,08
1070509	32-R1"MT	14,5	28,3	57,5	1	14,7	40	5	pce	21,66
1070510	32-R1 1/4"MT	18,8	28,4	66,1	1 1/4	18,9	20	5	pce	34,08

Uponor S-Press PLUS adapter male thread

- Made of tin-plated DZR brass
- Thread acc. to BS EN ISO 228-1



Item No.	Dimensions	l1 mm	l2 mm	l mm	R inch	z1 mm	Pallet/ Pack	Box/M QTY	UOM	Price per m/each
1091728	16-G3/8"MT	7,5	19,8	39	3/8	11,7	80	20	pce	5,34

S-Press PLUS

Uponor S-Press PLUS adapter female thread

- Made of tin-plated DZR brass

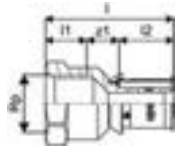

Item No.	Dimensions	Rp inch	l1 mm	l2 mm	l mm	z1 mm	Pallet/ Pack	Box/M QTY	UOM	Price per m/each
1070515	16-Rp1/2"FT	1/2	15	19,8	46,5	11,7	80	20	pce	9,86
1070516	20-Rp1/2"FT	1/2	15	21,3	46,5	10,2	120	15	pce	10,53
1070517	20-Rp3/4"FT	3/4	16,3	21,3	51,3	13,7	80	10	pce	13,69
1070518	20-Rp1"FT	1	19,1	21,3	52,1	11,7	80	20	pce	22,16
1070519	25-Rp3/4"FT	3/4	16,8	28,3	56	10,9	40	5	pce	14,94
1070520	25-Rp1"FT	1	19,1	28,3	59,1	11,7	40	5	pce	26,43
1070521	32-Rp1"FT	1	19,6	28,3	58	10,1	40	5	pce	27,61
1070522	32-Rp1 1/4"FT	1 1/4	21,4	28,3	62,4	12,7	20	5	pce	41,00

Uponor S-Press PLUS elbow

- Made of tin-plated DZR brass



Item No.	Dimensions	l1 mm	l2 mm	z1 mm	z2 mm	Pallet/ Pack	Box/M QTY	UOM	Price per m/each
1070523	16-16	33,8	33,8	14	14	80	20	pce	9,41
1070524	20-20	37,3	37,3	16	16	80	10	pce	12,72
1070525	25-25	47	47	19	19	40	5	pce	20,78
1070526	32-32	51	51	23	23	20	5	pce	30,32

Uponor S-Press PLUS bend

- Made of DZR brass

- Extra low pressure loss compared to an elbow type fitting



Item No.	Dimensions	l1 mm	l2 mm	z1 mm	z2 mm	Pallet/ Pack	Box/M QTY	UOM	Price per m/each
1070527	16-16	37	37	17	17	80	10	pce	10,78
1070528	20-20	40	40	18,7	18,7	80	10	pce	13,40
1070529	25-25	50	50	21,7	21,7	40	5	pce	20,59
1070530	32-32	56	56	27,7	27,7	20	5	pce	30,30

S-Press PLUS

Uponor S-Press PLUS elbow male thread

- Made of tin-plated DZR brass
- Male thread to BS EN 10226-1



Item No.	Dimensions	l1 mm	l2 mm	R inch	z1 mm	z2 mm	Pallet/ Pack	Box/M QTY	UOM	Price per m/each
1070531	16-R3/8"MT	27,3	36,5	3/8	12,5	16,7	80	20	pce	7,37
1070532	16-R1/2"MT	30,3	36,5	1/2	15,2	16,7	80	20	pce	10,45
1070533	20-R1/2"MT	32,3	40,5	1/2	15,2	19,2	80	10	pce	15,82
1070534	20-R3/4"MT	34,3	40,5	3/4	18	19,2	80	10	pce	16,74
1070535	25-R3/4"MT	36,3	47,6	3/4	19,8	19,2	40	5	pce	21,91
1070536	25-R1"MT	43,3	51,1	1	22	22,7	40	5	pce	23,59
1070537	32-R1"MT	43,3	51,1	1	22	22,7	20	5	pce	32,07

Uponor S-Press PLUS elbow male thread

- Made of tin-plated DZR brass
- Nut & olive ring for 10mm copper pipes.
- Thread acc. to BS EN ISO 228-1



Item No.	Dimensions	G inch	l1 mm	l2 mm	z1 mm	z2 mm	Pallet/ Pack	Box/M QTY	UOM	Price per m/each
1070538	16-G3/8"MT/10CU	3/8	27,3	36,5	15,3	16,7	20	1	pce	8,78

Uponor S-Press PLUS elbow female thread

- Made of tin plated DZR brass
- Female thread to BS EN 10226-1



Item No.	Dimensions	Rp inch	l1 mm	l2 mm	z1 mm	z2 mm	Pallet/ Pack	Box/M QTY	UOM	Price per m/each
1070539	16-Rp1/2"FT	0,5	33,3	38	18,3	18,2	80	10	pce	11,16
1070540	20-Rp1/2"FT	0,5	36,3	40,5	21,3	19,2	80	10	pce	14,71
1070541	20-Rp3/4"FT	0,75	35,6	43	19,3	21,7	40	10	pce	17,92
1070542	25-Rp3/4"FT	0,75	39,5	50	23,2	21,7	20	5	pce	22,24
1070543	25-Rp1"FT	1	44,5	53,8	25,4	25,5	20	5	pce	24,59
1070544	32-Rp1"FT	1	49,4	53,8	30,3	25,5	20	5	pce	33,42

S-Press PLUS

Uponor S-Press PLUS elbow 45deg

- Made of tin-plated DZR brass

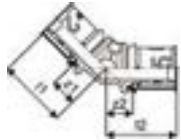

Item No.	Dimensions	l1 mm	l2 mm	z1 mm	z2 mm	Pallet/ Pack	Box/M QTY	UOM	Price per m/each
1070545	25-25	46	46	18	18	20	5	pce	38,72
1070546	32-32	49	49	23	23	20	5	pce	46,14

Uponor S-Press PLUS coupling

- Made of tin-plated DZR brass

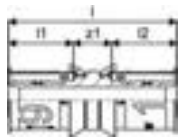

Item No.	Dimensions	l1 mm	l2 mm	l mm	z1 mm	Pallet/ Pack	Box/M QTY	UOM	Price per m/each
1070547	16-16	19,8	19,8	51,2	11,6	80	20	pce	8,86
1070548	20-20	21,3	21,3	54,2	11,6	80	10	pce	11,86
1070549	25-25	28,3	28,3	68,2	11,6	80	10	pce	18,15
1070550	32-32	28,3	28,3	68,2	11,6	40	5	pce	27,32

Uponor S-Press PLUS sliding coupling

- Connection of static pipes
- For in-line repairs of Uni-Pipe PLUS & MLC
- Made of tin-plated DZR brass
- With elongated press sleeve



Item No.	Dimensions	l1 mm	l2 mm	l mm	z1 mm	Pallet/ Pack	Box/M QTY	UOM	Price per m/each
1118706	16-16	20	20	100	60	80	10	pce	34,79
1118707	20-20	21	22	103	60	80	10	pce	36,04
1118708	25-25	29	28	117	60	40	5	pce	47,40
1118709	32-32	28	28	116	60	20	5	pce	55,56

Uponor S-Press PLUS reducer

- Made of tin-plated DZR brass

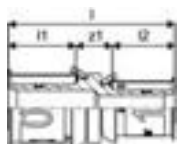

Item No.	Dimensions	l1 mm	l2 mm	l mm	z1 mm	Pallet/ Pack	Box/M QTY	UOM	Price per m/each
1070552	20-16	21,3	19,8	52,7	11,6	80	20	pce	10,98
1070553	25-16	28,3	19,8	59,7	11,6	80	10	pce	14,51
1070554	25-20	28,3	21,3	61,2	11,6	80	10	pce	15,61
1070555	32-20	28,3	21,3	61,2	11,6	80	10	pce	24,63
1070556	32-25	28,3	28,3	68,2	11,6	80	10	pce	27,32

S-Press PLUS

Uponor S-Press PLUS tee

- Made of tin-plated DZR brass



Item No.	Dimensions	l1 mm	l2 mm	l3 mm	z1 mm	z2 mm	z3 mm	Pallet/ Pack	Box/M QTY	UOM	Price per m/each
1070560	16-16-16	33,8	33,8	33,8	14	14	14	80	10	pce	12,47
1070561	20-20-20	37,3	37,3	37,3	15,6	15,6	15,6	80	10	pce	19,06
1070562	25-25-25	46,9	46,9	46,9	18,5	18,5	18,5	20	5	pce	29,80
1070563	32-32-32	51,4	51,4	51,4	23	23	23	20	5	pce	55,01

Uponor S-Press PLUS tee reducer

- Made of tin-plated DZR brass

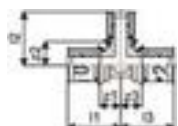

Item No.	Dimensions	l1 mm	l2 mm	l3 mm	z1 mm	z2 mm	z3 mm	Pallet/ Pack	Box/M QTY	UOM	Price per m/each
1070566	16-20-16	35,8	37,3	35,8	16	16	16	80	10	pce	21,75
1070567	20-16-16	35,3	35,8	33,8	14	16	14	40	10	pce	20,44
1070568	20-16-20	35,3	35,8	35,3	14	16	14	80	20	pce	20,80
1070569	20-20-16	37,3	37,3	35,8	16	16	16	80	20	pce	20,80
1070570	20-25-16	39,8	46,8	38,3	18,5	18,5	18,5	40	10	pce	25,64
1070571	20-25-20	39,8	46,8	39,8	18,5	18,5	18,5	40	10	pce	26,09
1070572	25-16-16	44,3	38,3	36,3	16	18,5	16,5	40	5	pce	22,60
1070573	25-16-20	44,3	38,3	37,8	16	18,5	16,5	40	5	pce	22,94
1070574	25-16-25	42,3	38,3	42,3	14	18,5	14	20	5	pce	25,56
1070575	25-20-16	44,3	39,8	36,3	16	18,5	16,5	40	5	pce	23,41
1070576	25-20-20	44,3	39,8	37,8	16	18,5	16,5	40	5	pce	24,43
1070577	25-20-25	44,3	39,8	44,3	16	18,5	16	20	5	pce	26,80
1070578	25-25-16	46,8	46,8	38,3	18,5	18,5	18,5	20	5	pce	23,47
1070579	25-32-25	50,3	47,8	50,3	22	19,5	22	20	5	pce	38,32
1070580	32-16-32	43,4	41,8	50,3	15	22	15	20	5	pce	34,08
1070581	32-20-32	45,4	43,3	45,4	17	22	17	20	5	pce	36,32
1070582	32-25-25	47,8	50,3	47,8	19,5	22	19,5	20	5	pce	37,68
1070583	32-25-32	47,9	50,4	47,9	19,5	22	19,5	20	5	pce	40,36

Uponor S-Press PLUS tee male thread

- Made of tin-plated DZR brass.

- Male thread to BS EN 10226-1

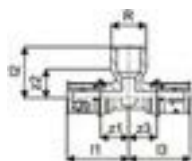

Item No.	Dimensions	l1 mm	l2 mm	l3 mm	R inch	z1 mm	z2 mm	z3 mm	Pallet/ Pack	Box/M QTY	UOM	Price per m/each
1070592	16-R1/2"MT-16	37,5	30,3	37,5	1/2	17,7	14,5	17,7	40	10	pce	20,60
1070593	25-R3/4"MT-25	47,5	36,3	47,5	3/4	19,2	21,2	19,2	20	5	pce	38,31
1070594	32-R3/4"MT-32	47,5	40,3	47,5	3/4	19,2	25,2	19,2	20	5	pce	50,13

S-Press PLUS

Uponor S-Press PLUS tee female thread

- Made of tin-plated DZR brass
- Female thread to BS EN 10226-1

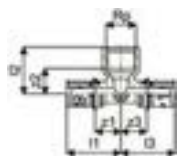

Item No.	Dimensions	Rp inch	l1 mm	l2 mm	l3 mm	z1 mm	z2 mm	z3 mm	Pallet/ Pack	Box/M QTY	UOM	Price per m/each
1070595	16-Rp1/2"FT-16	1/2	38	33	38	18,2	18	18,2	40	10	pce	26,30
1070596	20-Rp1/2"FT-20	1/2	40	35,3	40	18,7	20,3	18,7	60	15	pce	29,91
1070597	20-Rp3/4"FT-20	3/4	43	36,5	43	21,7	20,3	21,7	40	10	pce	31,68
1070598	25-Rp1/2"FT-25	1/2	47,5	37,3	47,5	19,2	22,3	19,2	20	5	pce	34,90
1070599	25-Rp3/4"FT-25	3/4	50	39,6	50	21,7	23,3	21,7	20	5	pce	37,28
1070600	32-Rp1/2"FT-32	1/2	46,5	40,3	46,5	18,2	25,3	18,2	20	5	pce	41,54
1070601	32-Rp3/4"FT-32	3/4	51	43,6	51	22,7	27,3	22,7	20	5	pce	46,90

Uponor S-Press PLUS adapter swivel nut

- Made of tin-plated DZR brass
- Demountable swivel nut for connection to on-wall fittings, equipment, filters and valves
- Thread acc. to BS EN ISO 228-1.

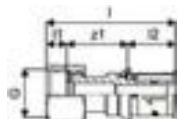

Item No.	Dimensions	G inch	l1 mm	l2 mm	l mm	z1 mm	Pallet/ Pack	Box/M QTY	UOM	Price per m/each
1070708	16-G3/8"SN	0,375	8,4	19,8	55,4	27,2	25	1	pce	16,64
1070602	16-G1/2"SN	0,5	8,4	19,8	53,4	25,2	30	1	pce	18,51
1070603	16-G3/4"SN	0,75	7,5	19,8	44	16,7	20	1	pce	20,34
1070604	20-G1/2"SN	0,5	8,4	21,3	59,4	29,7	20	1	pce	21,52
1070605	20-G3/4"SN	0,75	7,5	21,3	45,5	16,7	20	1	pce	22,86
1070606	25-G3/4"SN	0,75	7,9	28,3	63,9	27,7	15	1	pce	23,95
1070607	25-G1"SN	1	9	28,3	57	19,7	15	1	pce	24,82
1070608	25-G1 1/4 "SN	1 1/4	10,4	28,3	60,4	21,7	10	1	pce	25,23
1070609	32-G1"SN	1	8	28,3	65,4	29,2	10	1	pce	30,43
1070610	32-G1 1/4"SN	1 1/4	8,5	28,3	58,5	21,7	10	1	pce	41,22

Uponor S-Press PLUS adapter swivel nut

- Connection of Uni-Pipe PLUS pipes to Eurocone connections avoiding the use of compression type fittings
- Made of tin-plated DZR brass
- Press without bevel
- Demountable and resealable screw connector for 3/4" Eurocone connections
- Thread acc. to BS EN ISO 228-1.

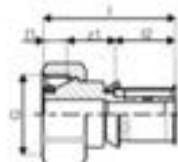

Item No.	Dimensions	G1 inch	l1 mm	l2 mm	l mm	z1 mm	Pallet/ Pack	Box/M QTY	UOM	Price per m/each
1141867	16-G3/4"FT Euro	3/4	7,6	19,8	43,6	16,2	80	10	pce	21,34

S-Press PLUS

Uponor S-Press PLUS adapter swivel nut

- Connection of Uni-Pipe PLUS pipes to Uni-C manifolds avoiding the use of compression type fittings
- Made of tin-plated DZR brass
- Press without bevel
- Demountable and resealable screw connector for 1/2" Uni-C manifold connections
- Thread acc. to BS EN ISO 228-1.



Item No.	Dimensions	G inch	l1 mm	l2 mm	l mm	z1 mm	Pallet/ Pack	Box/M QTY	UOM	Price per m/each
1141868	16-G1/2"FT Uni-C	1/2	6,3	19,8	48,3	22,3	80	10	pce	16,64
1141869	20-G1/2"FT Uni-C	1/2	6,3	21,3	50,8	24,3	80	10	pce	19,79

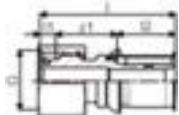

Uponor S-Press PLUS adapter swivel nut

- Connection of Uni-Pipe PLUS pipes to standard BS EN 1254-2 compression bodies without using a compression connection
- Made of tin-plated DZR brass
- Press without bevel
- Demountable and resealable screw connector for standard 15mm BS EN 1254-2 compression bodies
- Thread acc. to BS EN ISO 228-1.



Item No.	Dimensions	G inch	l1 mm	l2 mm	l mm	z1 mm	Pallet/ Pack	Box/M QTY	UOM	Price per m/each
1141873	16-G1/2"FT 15mm	1/2	6,4	21,9	48	19,4	80	10	pce	16,64

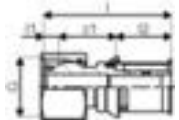

Uponor S-Press PLUS elbow swivel nut

- Made of tin-plated DZR brass
- Demountable screw fitting for connection to on-wall fittings, equipment, filters and shut-off valves
- Thread acc. to BS EN ISO 228-1.



Item No.	Dimensions	G inch	l1 mm	l2 mm	z1 mm	z2 mm	Pallet/ Pack	Box/M QTY	UOM	Price per m/each
1070611	16-G3/8"SN	0,375	41,2	36,5	33	16,7	20	1	pce	12,39
1070612	16-G1/2"SN	0,5	40,9	36,5	33	16,7	20	1	pce	17,10
1105818	16-G3/4"SN	3/4	45	39	37	19	10	1	pce	20,29
1070613	20-G1/2"SN	0,5	46,4	40,5	38,5	19,2	20	1	pce	21,62
1105819	20-G3/4"SN	3/4	45	41	37	19	10	1	pce	22,93
1070614	25-G3/4"SN	0,75	46,9	47,5	39	19,2	10	1	pce	24,88

S-Press PLUS

Uponor S-Press PLUS tap elbow M

- Made of tin-plated DZR brass
- Standard length
- For on wall installation or attachment with rotation protection to the Uponor Smart Aqua mounting angles and plates.



Item No.	Dimensions	Rp inch	l1 mm	l2 mm	l3 mm	k mm	z1 mm	z3 mm	Pallet/ Pack	Box/M QTY	UOM	Price per m/each
1070638	16-Rp3/8"FT	3/8	40,5	17	22	40	20,7	10,5	40	10	pce	10,31
1070639	16-Rp1/2"FT	1/2	40,5	17	22	40	20,7	7	40	10	pce	10,39
1070640	20-Rp1/2"FT	1/2	42	17	23	40	20,7	8	40	10	pce	12,43
1070641	20-Rp3/4"FT	3/4	45	17	23	40	23,7	6,5	20	5	pce	12,53
1070642	25-Rp3/4"FT	3/4	54	27,1	24,5	40	25,7	8,2	20	5	pce	21,14

Uponor S-Press PLUS tap elbow L

- Made of tin-plated DZR brass
- Long length
- For on wall installation or attachment with rotation protection to the Uponor Smart Aqua mounting angles and plates.



Item No.	Dimensions	Rp inch	l1 mm	l2 mm	l3 mm	k mm	z1 mm	z3 mm	Pallet/ Pack	Box/M QTY	UOM	Price per m/each
1070644	16-Rp1/2"FT	0,5	40,5	17	29	40	20,7	14	40	10	pce	10,71
1070645	20-Rp1/2"FT	0,5	46	20	30	40	24,7	15	40	10	pce	12,94

Uponor S-Press PLUS tap elbow XL

- Made of tin-plated DZR brass
- Extra long length
- For on wall installation or attachment with rotation protection to the Uponor Smart Aqua mounting angles and plates.



Item No.	Dimensions	Rp inch	l1 mm	l2 mm	l3 mm	k mm	z1 mm	z3 mm	Pallet/ Pack	Box/M QTY	UOM	Price per m/each
1070646	16-Rp1/2"FT	0,5	44,5	20	42	40	24,7	15	40	10	pce	11,34
1070647	20-Rp1/2"FT	0,5	46	21	42	40	24,7	15	40	10	pce	13,04

S-Press PLUS

Uponor S-Press PLUS U-tap elbow

- For use in hygienic serial or loop installations
- Made of tin-plated DZR Brass
- For on wall installation or attachment with rotation protection to the Uponor Smart Aqua mounting angles and plates.



Item No.	Dimensions	Rp inch	l1 mm	l2 mm	l3 mm	b mm	k mm	z1 mm	z2 mm	z4 mm	Pallet/ Pack	Box/M QTY	UOM	Price per m/each
1070629	16-Rp1/2"FT-16	1/2	55,5	55,5	20	45	40	35,7	35,7	8	20	5	pce	32,12
1070630	20-Rp1/2"FT-20	1/2	57	57	20	45	40	35,7	35,7	8	960	5	pce	37,91
1070631	20-Rp1/2"FT-16	1/2	57	55,5	20	45	40	35,7	35,7	8	960	5	pce	37,24
1070632	16-Rp1/2"FT-20	1/2	55,5	57	20	45	40	35,7	35,7	8	960	5	pce	37,24
1070633	25-Rp1/2"FT-25	1/2	64	64	27	60	40	35,7	35,7	9	576	3	pce	54,17
1070634	25-Rp1/2"FT-20	1/2	64	57	27	60	40	35,7	35,7	9	576	3	pce	69,45

Uponor S-PRESS PLUS U-tap elbow mixer

- Made of tin-plated DZR brass
- For in-wall mixer, or flushing tank connections in hygienic serial and loop installations.



Item No.	Dimensions	l1 mm	l2 mm	R inch	b mm	z1 mm	z2 mm	Pallet/ Pack	Box/M QTY	UOM	Price per m/each
1070636	16-16-R1/2"MT	57	60	1/2	45	41,5	40,2	960	5	pce	48,78
1070637	20-20-R3/4"MT	61	61,5	3/4	45	41,5	40,2	960	5	pce	57,63

Uponor S-PRESS PLUS tap elbow twin 90deg

- For use in hygienic serial or loop installations
- Made of tin-plated DZR brass
- For on wall installation or attachment with rotation protection to the Uponor Smart Aqua mounting angles and plates.
- Thread acc. to BS EN 10226-1



Item No.	Dimensions	Rp inch	l1 mm	l2 mm	l3 mm	k mm	k1 mm	z1 mm	z2 mm	z3 mm	Pallet/ Pack	Box/M QTY	UOM	Price per m/each
1070648	16-Rp1/2"FT-16	0,5	44	44,5	30	20	20	24,2	24,7	15	40	10	pce	23,13
1070649	20-Rp1/2"FT-20	0,5	45,5	46	30	20	20	24,2	24,7	15	40	10	pce	23,70

Uponor S-Press PLUS stop end

- Made of tin-plated DZR brass

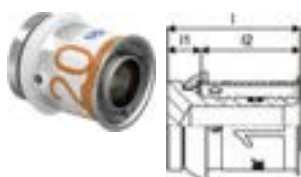

Item No.	Dimensions	l1 mm	l2 mm	l mm	Pallet/ Pack	Box/M QTY	UOM	Price per m/each
1070621	16	6,7	19,8	26,5	160	40	pce	6,04
1070622	20	6,7	21,3	28	7680	20	pce	6,69
1070623	25	6,7	28,3	35	3840	10	pce	7,88
1070624	32	6,7	28,3	35	1920	5	pce	15,57

S-Press PLUS

Uponor S-Press PLUS tap elbow mount.Unit

- Tap elbow assembly
- Rotation protected installed on mounting angle



Item No.	Dimensions	Rp inch	l mm	b mm	h mm	h1 mm	k mm	Pallet/ Pack	Box/M QTY	UOM	Price per m/each
1070661	16-Rp1/2"FT c/c80mm	0,5	320	196	47,5	46	80	5	1	pce	25,84
1070662	16-Rp1/2"FT c/c150mm	0,5	440	266	47,5	57	150	380	5	pce	26,99

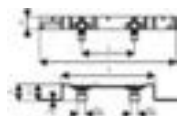

Uponor S-PRESS PLUS elbow adapter

- With plated copper pipe (EN 1057) 15 x 1 mm or 12 x 1 mm
- Connection of the plated copper pipe can be made using standard BS EN 1254-2 compression type fittings,
- or a compatible metal press connection.

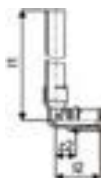

Item No.	Dimensions	l1 mm	l2 mm	z2 mm	Pallet/ Pack	Box/M QTY	UOM	Price per m/each
1070650	16-15CU l=150mm	166	36,5	16,7	2880	20	pce	11,39
1070651	16-12CU l=150mm	166	36,5	16,7	2880	20	pce	10,79

Uponor S-Press PLUS adapter wall penetr.

- For lead-through wall penetrations
- Dimensions of attachment plate (H x W x D) 100 x 50 x 2 mm.
- Hole diameter 33 mm.

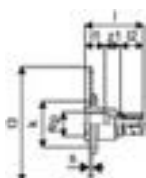

Item No.	Dimensions	Rp inch	l1 mm	l2 mm	l3 mm	l mm	s mm	k mm	z1 mm	Pallet/ Pack	Box/M QTY	UOM	Price per m/each
1070652	16-G1/2"FT	0,5	17	19,8	100	50,5	2	40	13,7	5	1	pce	21,48

Uponor S-Press PLUS tap elbow LWC

- Including twist-proof attachment and sound protection
- For lead-through wall penetrations



Item No.	Dimensions	G inch	Rp inch	l1 mm	l2 mm	g mm	k mm	z1 mm	z2 mm	Pallet/ Pack	Box/M QTY	UOM	Price per m/each
1070654	16-Rp1/2"FT l=35	0,75	0,5	58,5	46	3/4	50	19	26,2	5	1	pce	59,14

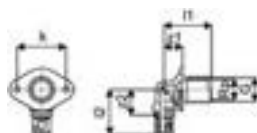

S-Press PLUS

Uponor S-Press PLUS mounting plate

- Made of galvanized steel.
- For the installation of Uponor Smart Aqua tap elbows
- Pre-set positioning of the connections
- Plastic pins and loss protected screws M6x12
- Pre-drilled mounting patterns



Item No.	Dimensions	l mm	s mm	h mm	k mm	k1 mm	w mm	Pallet/ Pack	Box/M QTY	UOM	Price per m/each
1121197	80/150mm	265	3	8,5	80	150	35	1120	5	pce	3,79



Uponor S-PRESS PLUS mounting angle

- Made of galvanized steel.
- For the installation of Uponor Smart Aqua tap elbows
- Pre-set positioning of the connections
- Plastic pins and loss protected screws M6x12
- Pre-drilled mounting patterns



Item No.	Dimensions	l mm	s mm	b mm	h mm	k mm	k1 mm	w mm	Pallet/ Pack	Box/M QTY	UOM	Price per m/each
1121196	100mm	396	3	222	57	100	--	35	5	1	pce	6,65
1121195	80/150mm	440	3	266	57	80	150	35	5	1	pce	6,82

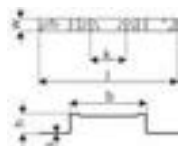

Uponor S-Press PLUS Adapter M+V

- Adapter fit to Copper and Stainless-steel pipes using pressing jaw type M or V (metal press connection)
- Must use Uponor Multilayer press jaws on the Multilayer connection
- Made of DZR brass (lead free)
- With fixed press sleeve, stop ring, pressed identification, colour code and test safety
- Press without bevel (Multilayer connection)



Item No.	In/Out	Dimensions	l1 mm	l2 mm	l mm	z1 mm	Pallet/ Pack	Box/M QTY	UOM	Price per m/each
1145403	03.25	16-15CU-SST	18	20	48	10	80	20	pce	12,41
1145404	03.25	20-22CU-SST	24	21	53	8	80	10	pce	20,22
1145405	03.25	25-22CU-SST	24	28	60	8	40	10	pce	24,41
1145406	03.25	32-28CU-SST	27	28	63	8	40	5	pce	33,75

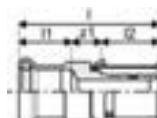

S-Press PLUS

Uponor S-Press PLUS adapter

- Adapter with plated copper spigot
- Connection of the plated copper pipe can be made using standard BS EN 1254-2 compression type fitting,
- or a compatible metal press connection.

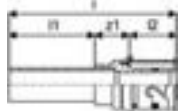

Item No.	Dimensions	l1 mm	l2 mm	l mm	z1 mm	Pallet/ Pack	Box/M QTY	UOM	Price per m/each
1070705	16-10CU	30	19,8	65,5	15,7	80	20	pce	8,43
1070706	16-12CU	30	19,8	65,5	15,7	80	20	pce	7,88
1070615	16-15CU	40	19,8	75,5	15,7	160	20	pce	6,38
1070707	20-15CU	39	21,3	76	15,7	3840	10	pce	9,22
1070617	20-22CU	41	21,3	81	18,7	60	15	pce	9,84
1070618	25-22CU	41	28,3	88	18,7	20	5	pce	11,72
1070619	25-28CU	43	28,3	92	20,7	1920	5	pce	21,46
1070620	32-28CU	43	28,3	92	20,7	20	5	pce	20,95

Uponor S-Press PLUS lever ball valve

- Lever ball valve
- Made of brass



Item No.	Dimensions	l1 mm	l2 mm	l mm	b1 mm	b2 mm	h mm	z1 mm	Pallet/ Pack	Box/M QTY	UOM	Price per m/each
1046603	16	19,8	19,8	121	100	60,5	43	81,4	6	1	pce	44,89
1046604	20	21,3	21,3	132	120	66	50	89,4	6	1	pce	61,84
1046605	25	28,3	28,3	147	120	73,5	50	90,4	6	1	pce	68,61
1046606	32	28,4	28,4	174	120	87	57	117,2	6	1	pce	92,75

Uponor S-Press PLUS radi crossing insulated

- For cross-over-free connection of a radiator on the raw floor
- Incl. insulation box, consisting of upper and lower part made of EPP (expanded polypropylene) with 13 mm insulation layer
- (corresponds to 50 % insulation in compliance with EnEV), WLG 035. Meets EnEV requirements in respect of pipe
- cross-overs and wall penetrations.
- Dimensions of insulation box
- (L x W x H): 115 x 115 x 55 mm.

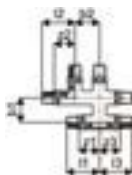

Item No.	Dimensions	l1 mm	l2 mm	l3 mm	s mm	b1 mm	b2 mm	z1 mm	z2 mm	z3 mm	Pallet/ Pack	Box/M QTY	UOM	Price per m/each
1070689	16-16-16	53,5	53,5	53,5		40	40	33,7	33,7	33,7	192	1	pce	72,63
1070690	20-16-16	56	56	55	40	40	40	33,7	33,7	33,7	192	1	pce	73,72
1070691	20-16-20	56	55	55	40	40	40	33,7	33,7	33,7	192	1	pce	74,94
1070692	20-20-20	56	56	56	40	40	40	33,7	33,7	33,7	192	1	pce	77,45

S-Press PLUS

Uponor S-Press PLUS radi elbow adapter unplated

- Made of DZR-brass
- With copper pipe 15 x 1 mm - EN 1057
- Connection of the plated copper pipe can be made using a standard BS EN 1254-2 compression type fitting,
- or a compatible metal press connection.



Item No.	Dimensions	l1 mm	l2 mm	z2 mm	Pallet/ Pack	Box/M QTY	UOM	Price per m/each
1070677	16-15CU l=250mm	266	36,5	16,7	1680	20	pce	18,99

Uponor S-Press PLUS radi elbow adapter plated

- With plated copper pipe (EN 1057) 15 x 1 mm or 22 x 1 mm
- Connection of the plated copper pipe can be made using a standard BS EN 1254-2 compression type fitting,
- or a compatible metal press connection.



Item No.	Dimensions	l1 mm	l2 mm	z2 mm	Pallet/ Pack	Box/M QTY	UOM	Price per m/each
1070678	16-15CU l=350mm	366	36,5	16,7	1680	20	pce	21,41
1070679	16-15CU l=1000mm	1116	36,5	16,7	400	20	pce	37,38
1070680	25-22CU l=250mm	250	47,5	19,2	640	20	pce	24,09

Uponor S-Press PLUS adapter baseboard

- For baseboard mounting and the universal connection of 16 or 20mm Uponor MLC and Uni-Pipe PLUS pipes to valve
- radiators with bottom connections
- Thread acc. to BS EN ISO 228-1



Item No.	Dimensions	G inch	l1 mm	l2 mm	b mm	b1 mm	b2 mm	z1 mm	z2 mm	Pallet/ Pack	Box/M QTY	UOM	Price per m/each
1070693	16-G1/2"MT-16	0,5	51	51	35	33,8	66,2	31,2	31,2	192	1	pce	77,34
1070695	16-G1/2"MT-0	0,5	51	27,5	35	33,8	66,2	31,2		192	1	pce	71,95
1094219	0-G1/2"MT-16	1/2	27,5	51	35	33,8	66,2		31,2	192	1	pce	71,95
1070697	20-G1/2"MT-20	0,5	52,5	52,5	35	33,8	65	31,2	31,2	192	1	pce	80,31

Uponor S-Press PLUS tap elbow mount. Unit radi



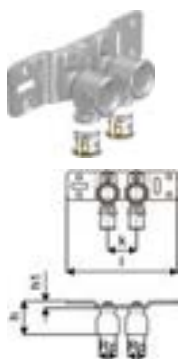



- Pre-mounted unit contains of two Uponor S-Press PLUS Smart Aqua tap elbows 16-1/2FT
- Rotation protected installed on mounting angle.



Item No.	Dimensions	Rp inch	l mm	h mm	h1 mm	k mm	Pallet/ Pack	Box/M QTY	UOM	Price per m/each
1070684	16-Rp1/2"FT c/c50mm	0,5	150	41	8,5	50	960	5	pce	23,68

S-Press PLUS

Compatible with:

Item No.	Dimension	Pallet/ Pack	Box/M QTY	UOM	Price per m/each
 1057844	Uponor Smart Aqua mounting rack 2m	10	1	pce	23,78
 1057847	Uponor Smart Aqua 10 pins+20 screws		1	set	6,74
 1015425	Uponor Smart Radi adapter plated G1/2"MT-15CU l=350mm	640	20	pce	16,62
 1013970	Uponor Smart Radi compr. connection set Danfoss 16-G1/2"MT	20	1	pce	6,80
 1014016	Uponor Smart Radi compr. connection set Oventrop 16-G1/2"MT	20	1	pce	6,57
 1011370	Uponor Smart Radi cover plate dividable 16 white	1350	50	pce	0,57
 1011372	Uponor Smart Radi cover plate dividable 20 white	1350	50	pce	0,55

S-Press



Benefits

- Dimensional Colour coded
- Inspection windows on pressing sleeve
- Safety test
- Fittings manufactured from robust PPSU composite, or tin-plated brass.

Uponor S-Press is the perfect solution to create fast, reliable, permanent and watertight connections.

Compatible with the high-performance Uni-Pipe Plus and MLC pipe systems, S-Press is ideal for delivering hygienic hot and cold drinking water, heating or chilled water systems, and hydronic radiant heating or cooling.

Our comprehensive range features a wide range of adapters for simple connections to plant, equipment, controls, valves and to other pipe materials such as copper and stainless steel.

Specification

- Tin-plated brass or PPSU
- With fixed press sleeve
- Stop ring
- Colour code
- Test safety
- Male and female threads to BS EN 10226-1

Uponor S-Press elbow PPSU

- Fast installation with easy bevel and without calibration
- Inspection windows on press sleeve
- Colour code



Application

Tested/approved according to BS EN ISO 21003 Multilayer piping systems for hot and cold water installations inside buildings for application class 1,2,4,5/10bar

Domestic water services: The permanent operating temperature from 20°C to 70°C at a maximum permanent operating pressure of 10 bar. The short-term malfunction temperature is 95°C for a period of 100 hours in the operating life time.

Domestic cold water services : where the water temperature does not exceed 20°C at a maximum permanent operating pressure of 16bar.

Heating: The permanent operating temperature ranges up to 80°C at a maximum permanent operating pressure of 10 bar. The short-term malfunction temperature is 100°C for a period of 100 hours in the operating life time.

Certification

UK Reg4 approval

- WRAS or
- KIWA

To meet the requirements of the Water Supply (Water Fittings) Regulations 1999

Item No.	Dimensions	l1 mm	l2 mm	z1 mm	z2 mm	Pallet/Pack	Box/M QTY	UOM	Price per m/each
1046386	40-40	67,6	67,6	28,6	28,6	960	5	pce	34,73
1046387	50-50	72,6	72,6	33,6	33,6	576	3	pce	51,48
1032877	63-63	101,2	101,2	40,3	40,3	210	1	pce	109,94
1032878	75-75	107,5	107,5	46,6	46,6	210	1	pce	148,62

S-Press

Uponor S-Press elbow 45deg PPSU

- Fast installation with easy bevel and without calibration
- Inspection windows on press sleeve
- Colour code

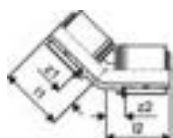

Item No.	Dimensions	l1 mm	l2 mm	z1 mm	z2 mm	Pallet/ Pack	Box/M QTY	UOM	Price per m/each
1046388	40-40	55,6	55,6	16,6	16,6	960	5	pce	57,42
1046389	50-50	58,6	58,6	20	20	576	3	pce	76,56
1032879	63-63	83,4	83,4	22,5	22,5	192	1	pce	97,75
1032880	75-75	86,3	86,3	25,4	25,4	192	1	pce	116,63

Uponor S-Press coupling PPSU

- Fast installation with easy bevel and without calibration
- Inspection windows on press sleeve
- Colour code

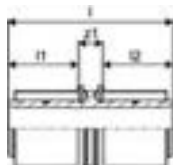

Item No.	Dimensions	l1 mm	l2 mm	l mm	z1 mm	Pallet/ Pack	Box/M QTY	UOM	Price per m/each
1046401	40-40	38,8	38,8		13,4	960	5	pce	29,94
1046402	50-50	38,8	38,8		13,4	576	3	pce	38,29
1032881	63-63	60,9	60,9		14,8	384	1	pce	83,11
1032882	75-75	60,9	60,9	137	14,8	384	1	pce	127,74

Uponor S-Press reducer PPSU

- Fast installation with easy bevel and without need for calibration
- Inspection windows on press sleeve
- Colour code

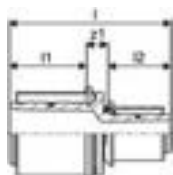

Item No.	Dimensions	l1 mm	l2 mm	l mm	z1 mm	Pallet/ Pack	Box/M QTY	UOM	Price per m/each
1046406	50-40	38,8	39	91	13,2	576	3	pce	39,51
1032883	63-40	60,9	37	114,8	16,9	384	1	pce	60,78
1032884	63-50	60,9	37	114,8	16,9	384	1	pce	82,65
1032885	75-50	60,9	37	114,8	17,3	384	1	pce	91,39
1032886	75-63	60,5	59	136,6	16,7	384	1	pce	93,08

S-Press

Uponor S-Press reducer PPSU

- Fast installation with easy bevel and without need for calibration
- Inspection windows on press sleeve
- Material: PPSU

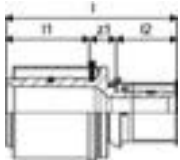

Item No.	Dimensions	l1 mm	l2 mm	l mm	z1 mm	Pallet/ Pack	Box/M QTY	UOM	Price per m/each
1039941	40-25	38,9	28,3	79,5	12,3	960	5	pce	27,73
1039942	40-32	38,9	27,8	79,5	12,8	960	5	pce	31,31
1039943	50-32	38,9	27,8	79,5	12,8	1152	3	pce	37,38

Uponor S-Press tee PPSU

- Fast installation with easy bevel and without need for calibration
- Inspection windows on press sleeve
- Colour code

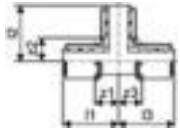

Item No.	Dimensions	l1 mm	l2 mm	l3 mm	z1 mm	z2 mm	z3 mm	Pallet/ Pack	Box/M QTY	UOM	Price per m/each
1046390	40-40-40	67,6	67,5	67,6	28,6	28,5	28,6	720	5	pce	52,68
1046391	50-50-50	72,6	72,5	72,6	33,2	33,1	33,2	288	3	pce	78,99
1032887	63-63-63	101,2	101,1	101,2	42,2	39,6	42,2	150	1	pce	108,35
1032888	75-75-75	107,5	107,4	107,5	46,6	46,5	46,6	150	1	pce	148,02

Uponor S-Press tee reducer PPSU

- Fast installation with easy bevel and without need for calibration
- Inspection windows on press sleeve
- Colour code

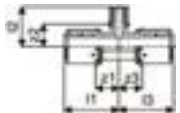

Item No.	Dimensions	l1 mm	l2 mm	l3 mm	z1 mm	z2 mm	z3 mm	Pallet/ Pack	Box/M QTY	UOM	Price per m/each
1039962	40-20-40	67,6	49	67,6	28,7	27,7	28,7	960	5	pce	40,79
1039963	40-25-32	67,6	56	56,1	28,7	27,7	28,3	960	5	pce	44,15
1039964	40-25-40	67,6	56	67,6	28,7	27,7	28,7	720	5	pce	44,15
1039965	40-32-32	67,6	56	56,1	28,7	28,2	28,3	960	5	pce	42,95
1039966	40-32-40	67,6	56	67,6	28,7	28,2	28,7	720	5	pce	46,56
1039967	50-25-40	72,6	61	72,6	33,7	32,7	33,7	432	3	pce	55,98
1039968	50-25-50	72,6	61	72,6	33,7	32,7	33,7	432	3	pce	58,48
1039969	50-32-50	72,6	61	72,6	33,7	33,2	33,7	432	3	pce	65,66

S-Press

Uponor S-Press tee reducer PPSU

- Fast installation with easy bevel and without need for calibration
- Inspection windows on press sleeve
- Colour code

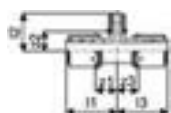

Item No.	Dimensions	l1 mm	l2 mm	l3 mm	z1 mm	z2 mm	z3 mm	Pallet/ Pack	Box/M QTY	UOM	Price per m/each
1046400	50-40-50	72,6	72,5	72,6	33,3	33,4	33,3	288	3	pce	70,65
1032889	63-25-63	101,2	67,8	101,2	40,3	38,8	40,3	150	1	pce	115,18
1032890	63-32-63	101,2	67,8	101,2	40,3	38,8	40,3	150	1	pce	93,29
1032891	63-40-63	101,2	79,3	101,2	40,3	40,4	40,3	150	1	pce	99,46
1032892	75-32-75	107,5	74,1	107,5	46,6	45	46,6	150	1	pce	120,51
1032893	75-40-75	107,5	85,6	107,5	46,6	44,3	46,6	150	1	pce	121,41
1032894	75-50-75	107,5	85,6	107,5	46,6	48,6	46,6	150	1	pce	134,47

Uponor S-Press adapter male thread

- Made of tin-plated brass
- Contoured Aluminium-sleeve with inspection windows
- Fast 3-step installation (press without bevel)
- Colour coded, breakaway press indicator

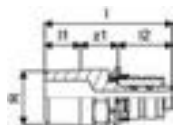

Item No.	Dimensions	l1 mm	l2 mm	l mm	R inch	z1 mm	Pallet/ Pack	Box/M QTY	UOM	Price per m/each
1014513	14-R1/2"MT	14	22	50	1/2	11	80	20	pce	8,39

Uponor S-Press adapter male thread

- Made of tin-plated brass
- Fast installation with easy bevel and without need for calibration
- Inspection windows on press sleeve
- Colour code

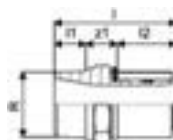

Item No.	Dimensions	l1 mm	l2 mm	l mm	R inch	d mm	z1 mm	Pallet/ Pack	Box/M QTY	UOM	Price per m/each
1046901	40-R1 1/4"MT	20	37,5	77,5	1 1/4	20		960	5	pce	35,55
1046902	40-R1 1/2"MT	20	37,5	72	1 1/2	40	14,5	960	5	pce	46,36
1046905	50-R1 1/2"MT	20	37,5	72	1 1/2	50	14,5	1152	3	pce	50,54
1046906	50-R2"MT	24	37,5	83,5	2	50	22	576	3	pce	76,09
1032895	63-R2"MT	28	60,6	111	2	63	22	336	1	pce	102,21
1032896	75-R2 1/2"MT	27	60,6	109,86	2 1/2	75	22	336	1	pce	120,03

S-Press

Uponor S-Press adapter female thread

- Made of tin-plated brass
- Contoured Aluminium-sleeve with inspection windows
- Fast 3-step installation (press without bevel)
- Colour coded, breakaway press indicator

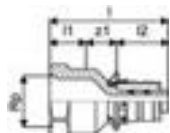

Item No.	Dimensions	Rp inch	l mm	z1 mm	Pallet/ Pack	Box/M QTY	UOM	Price per m/each
1014515	14-Rp1/2"FT	1/2	49	13	80	20	pce	9,29

Uponor S-Press adapter female thread

- Made of tin-plated brass
- Fast installation with easy bevel and without need for calibration
- Inspection windows on press sleeve
- Colour code

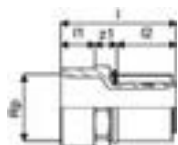

Item No.	Dimensions	Rp inch	l1 mm	l2 mm	l mm	z1 mm	Pallet/ Pack	Box/M QTY	UOM	Price per m/each
1046903	40-Rp1 1/4"FT	1 1/4	21,4	37,6	72,9	13,9	960	5	pce	39,90
1046904	40-Rp1 1/2"FT	1 1/2	21,4	37,5	75,5	16,6	960	5	pce	43,19
1046907	50-Rp1 1/2"FT	1 1/2	21,4	37,5	72,5	13,6	1152	3	pce	48,11

Uponor S-Press elbow

- Made of tin-plated brass
- Fast installation with easy bevel and without need for calibration
- Inspection windows on press sleeve
- Colour code



Item No.	Dimensions	l1 mm	l2 mm	z1 mm	z2 mm	Pallet/ Pack	Box/M QTY	UOM	Price per m/each
1046908	40-40	71,5	71,5	33,6	33,6	600	5	pce	44,82
1046911	50-50	78,5	78,5	40,6	40,6	240	3	pce	61,68

S-Press

Uponor S-Press elbow

- Made of tin-plated brass
- Contoured Aluminium-sleeve with inspection windows
- Fast 3-step installation (press without bevel)
- Colour coded, breakaway press indicator

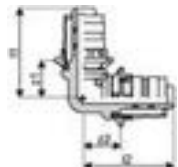

Item No.	Dimensions	l1 mm	l2 mm	z1 mm	z2 mm	Pallet/ Pack	Box/M QTY	UOM	Price per m/each
1133445	14-14	36	36	14,7	14,7	80	20	pce	8,48

Uponor S-Press coupling

- Made of tin-plated brass
- Contoured Aluminium-sleeve with inspection windows
- Fast 3-step installation (press without bevel)
- Colour coded, breakaway press indicator

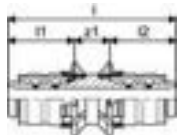

Item No.	Dimensions	l1 mm	l2 mm	l mm	z1 mm	Pallet/ Pack	Box/M QTY	UOM	Price per m/each
1015154	14-14	21,3	21,3	54	11,4	80	10	pce	8,24

Uponor S-Press coupling

- Made of tin-plated brass
- Fast installation with easy bevel and without need for calibration
- Inspection windows on press sleeve
- Colour code

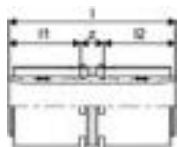

Item No.	Dimensions	l1 mm	l2 mm	l mm	z1 mm	Pallet/ Pack	Box/M QTY	UOM	Price per m/each
1046932	40-40	37,8	37,9	88	12,3	960	5	pce	37,35
1046935	50-50	37,8	37,9	88	12,3	576	3	pce	47,85

S-Press

Uponor S-Press reducer

- Made of tin-plated brass
- Fast installation with easy bevel and without need for calibration
- Inspection windows on press sleeve
- Colour code

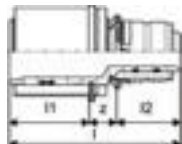

Item No.	In/Out	Dimensions	l1 mm	l2 mm	l mm	z1 mm	Pallet/ Pack	Box/M QTY	UOM	Price per m/each
1046930	12.26	40-25	37,9	30,3	81,2	13	960	5	pce	34,26
1046931	12.26	40-32	37,9	30,3	81,2	13	960	5	pce	39,99
1046933	12.26	50-32	37,9	30,3	81,2	13	1152	3	pce	46,76
1046934		50-40	37,8	37,8	89,2	13,6	576	3	pce	47,79

Uponor S-Press reducer

- Made of tin-plated brass
- Contoured Aluminium-sleeve with inspection windows
- Fast 3-step installation (press without bevel)
- Colour coded, breakaway press indicator

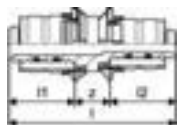

Item No.	Dimensions	l1 mm	l2 mm	l mm	z1 mm	Pallet/ Pack	Box/M QTY	UOM	Price per m/each
1015162	16-14	21,3	21,3	54	11,4	80	20	pce	9,22

Uponor S-Press tee

- Made of tin-plated brass
- Fast installation with easy bevel and without calibration
- Inspection windows on press sleeve
- Colour code

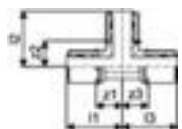

Item No.	Dimensions	l1 mm	l2 mm	l3 mm	z1 mm	z2 mm	z3 mm	Pallet/ Pack	Box/M QTY	UOM	Price per m/each
1046921	40-40-40	71,5	71,5	71,5	33,6	33,6	33,6	400	5	pce	61,71
1046928	50-50-50	78,5	78,5	78,5	40,6	40,6	40,6	300	3	pce	90,42

S-Press

Uponor S-Press tee

- Made of tin-plated brass
- Contoured Aluminium-sleeve with inspection windows
- Fast 3-step installation (press without bevel)
- Colour coded, breakaway press indicator

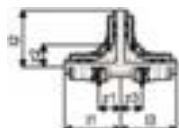

Item No.	Dimensions	l1 mm	l2 mm	l3 mm	z1 mm	z2 mm	z3 mm	Pallet/ Pack	Box/M QTY	UOM	Price per m/each
1014886	14-14-14	35	35	35	13,7	13,7	13,7	80	10	pce	11,56

Uponor S-Press tee reducer

- Made of tin-plated brass
- Fast installation with easy bevel and without calibration
- Inspection windows on press sleeve
- Colour code

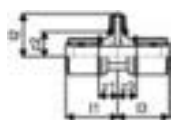

Item No.	In/Out	Dimensions	l1 mm	l2 mm	l3 mm	z1 mm	z2 mm	z3 mm	Pallet/ Pack	Box/M QTY	UOM	Price per m/each
1046916	12.26	40-20-40	60	50	60	22,1	27,7	22,1	400	5	pce	47,39
1046917	12.26	40-25-32	61	60	53	23,1	29,7	22,7	500	5	pce	52,91
1046918	12.26	40-25-40	61	60	61	23,1	29,7	23,1	400	5	pce	52,98
1046919	12.26	40-32-32	64,5	60	56,5	26,6	29,7	26,2	400	5	pce	51,97
1046920	12.26	40-32-40	64,5	60	64,5	26,6	29,7	26,6	400	5	pce	57,70
1046924	12.26	50-25-40	61	65	61	23,1	34,7	23,1	300	3	pce	61,26
1046925	12.26	50-25-50	61	65	61	23,1	34,7	23,1	240	3	pce	61,85
1046926	12.26	50-32-50	64,5	65	64,5	26,6	34,7	26,6	300	3	pce	75,20
1046927		50-40-50	71,5	78,5	71,5	33,6	40,6	33,6	300	3	pce	63,17

Uponor S-Press tee reducer

- Made of tin-plated brass
- Contoured Aluminium-sleeve with inspection windows
- Fast 3-step installation (press without bevel)
- Colour coded, breakaway press indicator

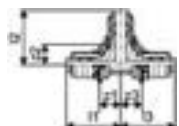

Item No.	Dimensions	l1 mm	l2 mm	l3 mm	z1 mm	z2 mm	z3 mm	Pallet/ Pack	Box/M QTY	UOM	Price per m/each
1014888	14-16-14	35	35	35	13,7	13	13,7	80	10	pce	13,00
1014912	16-14-14	35	35	35	13,7	13,7	13,7	80	10	pce	12,47
1014915	16-14-16	35	35	35	13,7	13,7	13,7	80	10	pce	13,41

S-Press

Uponor S-Press adapter

- Made of tin plated brass
- Contoured aluminium sleeve with inspection windows
- With copper pipe 15 x 1 mm - EN 1057
- The connection of the plated copper pipe can be made using a standard BS EN 1254-2 compression type fitting, or a compatible metal press connection.



Item No.	Dimensions	l1 mm	l2 mm	l mm	z1 mm	Pallet/ Pack	Box/M QTY	UOM	Price per m/each
1014511	14-15CU	40	21,3	77	15,7	80	10	pce	9,35

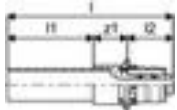

Uponor S-Press elbow male thread

- Made of tin-plated brass
- Fast installation with easy bevel and without need for calibration
- Inspection windows on press sleeve
- Colour code



Item No.	Dimensions	l1 mm	l2 mm	R inch	z1 mm	z2 mm	Pallet/ Pack	Box/M QTY	UOM	Price per m/each
1046909	40-R1 1/4"MT	49	72	1 1/4	30,3	34,1	500	5	pce	48,11



Uponor S-Press elbow female thread

- Made of tin-plated brass
- Fast installation with easy bevel and without need for calibration
- Inspection windows on press sleeve
- Colour code



Item No.	Dimensions	Rp inch	l1 mm	l2 mm	z1 mm	z2 mm	Pallet/ Pack	Box/M QTY	UOM	Price per m/each
1046910	40-Rp1 1/2"FT	1 1/2	59	74,5	37,6	36,8	500	5	pce	52,44
1046912	50-Rp1 1/2"FT	1,5	59	78,5	37,6	40,8	300	3	pce	60,80



S-Press

Uponor S-Press elbow 45deg

- Made of tin-plated brass
- Fast installation with easy bevel and without need for calibration
- Inspection windows on press sleeve
- Colour code



Item No.	Dimensions	l1 mm	l2 mm	z1 mm	z2 mm	Pallet/ Pack	Box/M QTY	UOM	Price per m/each
1046913	40-40	58,5	58,5	20,6	20,6	500	5	pce	93,46
1046914	50-50	62,5	62,5	24,6	24,6	300	3	pce	103,47

Uponor S-Press sliding coupling

- Made of tin plated brass
- Extended press sleeve
- Can be used as a repair coupling
- Inspection windows on press sleeve
- Colour coded

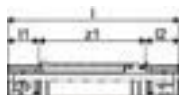

Item No.	Dimensions	l1 mm	l2 mm	l mm	z1 mm	Pallet/ Pack	Box/M QTY	UOM	Price per m/each
1118710	40-40	42	38	138	58	12	3	pce	70,58

Uponor S-Press tee female thread

- Made of tin-plated brass
- Fast installation with easy bevel and without need for calibration
- Inspection windows on press sleeve
- Colour code
- Female thread to BS EN 10226-1

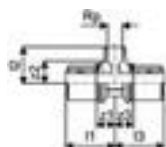

Item No.	Dimensions	Rp inch	l1 mm	l2 mm	l3 mm	z1 mm	z2 mm	z3 mm	Pallet/ Pack	Box/M QTY	UOM	Price per m/each
1046922	40-Rp1/2"FT-40	0,5	68,5	46,7	68,5	30,6	29,5	30,6	500	5	pce	47,79
1046923	40-Rp3/4"FT-40	0,75	64	47	64	26,1	30,7	26,1	400	5	pce	49,71
1046929	50-Rp1"FT-50	1	71,5	56	71,5	33,6	36,9	33,6	240	3	pce	59,75

S-Press

Uponor S-Press adapter swivel nut

- Made of tin-plated brass
- Demountable and resealable screw fitting for connection to valves and equipment
- Supplied with sealing gasket
- Fast installation with easy bevel and without need for calibration
- Inspection windows on press sleeve
- Colour code
- Thread acc. to BS EN ISO 228-1.

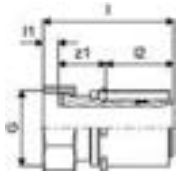

Item No.	Dimensions	G inch	Rp inch	l1 mm	l2 mm	l mm	z1 mm	Pallet/ Pack	Box/M QTY	UOM	Price per m/each
1060094	40-G1 1/4"SN	1 1/4	1,25	8,5	37,8	72,7	26,4	960	5	pce	47,47
1046937	40-G1 1/2"SN	1,5		9,5	37,9	77,2	29,8	960	5	pce	51,48
1060095	50-G1 1/2"SN	1 1/2	1,5	9,5	37,6	78,5	31,4	1152	3	pce	58,63
1046939	50-G2"SN	2		12	37,9	81,7	31,8	576	3	pce	64,72

Uponor S-Press lever ball valve S-Press

- Made of tin plated brass
- Lever ball valve
- Colour code
- Inspection windows on press sleeve



Item No.	Dimensions	l1 mm	l2 mm	l mm	b1 mm	b2 mm	h mm	z1 mm	Pallet/ Pack	Box/M QTY	UOM	Price per m/each
1046607	40	37,6	37,6	213	158	106,5	73	137,8	4	1	pce	173,90
1046608	50	37,6	37,6	226	158	113	79	150,8	4	1	pce	201,35

Smart Aqua



Benefits

- For hygienic water installations
- Stable connection points
- Fast, leaktight installation
- Clean, standardized layout
- Durable, corrosionresistant components

The Smart Aqua range provides coordinated connection, mounting and support components for creating secure, hygienic and reliable tapwater installation points.

The system includes tap elbows, mounting plates, mounting angles, racks and terminal boxes engineered for precise alignment, stable fixing and longterm performance.

Suitable for use with Uponor's Uni Pipe PLUS & SPress PLUS composite piping system, or for use with Q&E PE-X where indicated.

Specification

- Elbows for tap connection and
- Q&E rings must be ordered separately unless detailed in the description

Application

- For tap water installations
- Male and female threads acc.to BS EN 10226-1 (unless specified differently)

Certification

UK Reg4 approval

- WRAS or
- KIWA

To meet the requirements of the Water Supply (Water Fittings) Regulations 1999

Uponor Smart Aqua 10 pins+20 screws

- Pins and screws for mounting plates, angles, and tracks.



Item No.	c/c1 mm	l mm	do1 mm	do2 mm	Pallet/ Pack	Box/M QTY	UOM	Price per m/each
1057847	10	17	4	10		1	set	6,74



Smart Aqua

Uponor S-Press tap elbow

- Made of tin-plated brass
- Contoured Aluminium-sleeve with inspection windows
- Fast 3-step installation (press without bevel)
- Colour coded breakaway press indicator
- For on wall installation or attachment with rotation protection to the Uponor Smart Aqua mounting angles and plates.

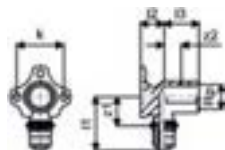

Item No.	Dimensions	Rp inch	l1 mm	l2 mm	l3 mm	k mm	z1 mm	z2 mm	Pallet/ Pack	Box/M QTY	UOM	Price per m/each
1015437	14-Rp1/2"FT	1/2	46	20	20	40	24,7	5	40	10	pce	9,65

Uponor S-Press elbow adapter

- Made of tin-plated brass
- Contoured Aluminium-sleeve with inspection windows
- Fast 3-step installation (press without bevel)
- Colour coded breakaway press indicator
- With copper pipe 15 x 1 mm - EN 1057
- Connection of the plated copper pipe can be made using a standard BS EN 1254-2 compression type fitting, or a compatible metal press connection.



Item No.	Dimensions	l1 mm	l2 mm	z2 mm	Pallet/ Pack	Box/M QTY	UOM	Price per m/each
1014654	14-12CU l=150mm	166	38	16,7		20	pce	13,12

Uponor Smart Aqua mounting rack

- Made of galvanized steel.
- For the installation of Uponor Smart Aqua tap elbows
- Pre-set positioning of the connections
- Plastic pins and loss protected screws M6x12
- Pre-drilled mounting patterns

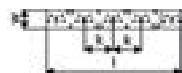

Item No.	Dimensions	l mm	s mm	k mm	Pallet/ Pack	Box/M QTY	UOM	Price per m/each
1057844	2m	2000	3,0	75	10	1	pce	23,78

Smart Aqua

Uponor Smart Aqua U-tap elbow Q&E

- U tap-elbow for hygienic loop or series installations

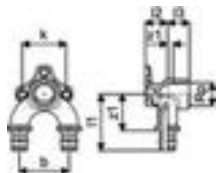

Item No.	Dimensions	Rp inch	l1 mm	l2 mm	l3 mm	b mm	k mm	z1 mm	z2 mm	Pallet/ Pack	Box/M QTY	UOM	Price per m/each
1059820	16-Rp1/2"FT-16	0,5	51,5	20	20	45	40	33,5	5	5	1	pce	48,95
1059821	20-Rp1/2"FT-20	0,5	55,5	20	20	45	40	35,1	5	5	1	pce	63,32

Uponor Smart Aqua tap elbow Q&E PL

- Made of brass
- Standard length
- For on wall installation or attachment with rotation protection to the Uponor Smart Aqua mounting angles and plates.

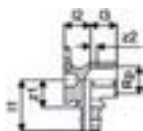

Item No.	Dimensions	Rp inch	l1 mm	l2 mm	l3 mm	z1 mm	z2 mm	p bar	Pallet/ Pack	Box/M QTY	UOM	Price per m/each
1059822	16-Rp1/2"FT	1/2	39	20	20	21	5	6+10	40	5	pce	14,38
1059823	20-Rp1/2"FT	1/2	40	20	20	18	5	6+10	40	5	pce	16,35

Uponor Smart Aqua tap elbow Q&E PPSU

- Material: PPSU



Item No.	Dimensions	Rp inch	l1 mm	l2 mm	l3 mm	k mm	z1 mm	z2 mm	p bar	Pallet/ Pack	Box/M QTY	UOM	Price per m/each
1042342	16-Rp1/2" l=43mm	0,5	34	16,5	26,5	36	16	9,6	6+10	40	5	pce	9,04

Smart Radi



Benefits

- Fast installation
- Stable, aligned radiator connections
- Reliable, leaktight installation
- Clean penetration and valve interface solutions
- Durable, corrosionresistant components

The Smart Radi range provides fittings, adapters, cover plates and accessories designed for creating reliable, clean and professional radiator connection points in heating systems.

The range supports both high and low temperature radiators, and integrates seamlessly with Uponor's Uni-Pipe PLUS & MLC composite piping systems.

Components include plated copper connection adapters, compression sets, protective sleeves and mounting solutions to provide fast and reliable connections to multiple outlet types.

Specification

- Suitable for coated copper pipes (15 x 1 mm), MLCP 16 x 2 mm, PEXa and MLC connection lines
- Components made of tinplated brass, coated brass, coated copper, polystyrene, and PP
- Compatible with S-Press, Q&E, clamp compression adapters and Eurocone interfaces

If not different mentioned:

- Firerated cover plates to BS EN 13501-1 (depending on model)
- Q&E rings must be ordered separately if not differently mentioned

Application

- Connecting radiators to Uponor MLCP or Uni Pipe PLUS heating circuits
- Providing stable, aligned flow and return lines using dedicated adapters and connection boxes
- Interfacing with radiator valves via systemspecific compression sets (Danfoss, Heimeier, Oventrop)
- Protecting and guiding pipes at wall or floor penetrations with cover plates and protective sleeves

Uponor S-Press radi elbow adapter plated

- Made of tin-plated brass
- Contoured Aluminium-sleeve
- Fast 3-step installation (press without bevel)
- Colour code
- With copper pipe 15 x 1 mm - EN 1057
- Connection of the plated copper pipe can be made using a standard BS EN 1254 compression type fitting,
- or a compatible metal press connection.

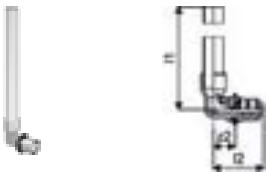

Item No.	Dimensions	l1 mm	l2 mm	z2 mm	Pallet/ Pack	Box/M QTY	UOM	Price per m/each
1015615	14-15CU l=350mm	366	38	16,7		20	pce	17,48

Smart Radi

Uponor Smart Radi adapter plated

- Made of plated copper pipe
- Copper pipe 15 x 1 mm with self sealing thread for the connection to radiator
- Fits to all Uponor press tap elbow MLC, press tap wall plate MLC and press female connection 1/2" MLC
- Connection to the radiator with the Uponor Eurocone compression adapter Cu, or standard BS EN 1254-2 compression fitting



Item No.	Dimensions	G inch	l mm	z1 mm	Pallet/ Pack	Box/M QTY	UOM	Price per m/each
1015425	G1/2"MT-15CU l=350mm	1/2	369	356	640	20	pce	16,62

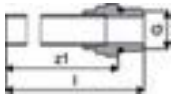

Uponor Smart Radi compr. connection set Danfoss

- Made of coated brass
- Pressure screw with male thread, with inner sleeve and clamp ring, fit to Danfoss radiator valves with female thread
- Blue O-ring, made of EPDM.

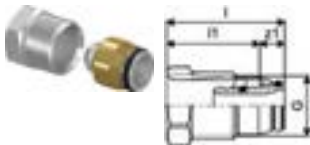

Item No.	Dimensions	G inch	l1 mm	l mm	z1 mm	Pallet/ Pack	Box/M QTY	UOM	Price per m/each
1013970	16-G1/2"MT	1/2	29,2	37	7,8	20	1	pce	6,80

Uponor Smart Radi compr. connection set Oventrop

- Made of coated brass
- Pressure screw with male thread, with inner sleeve and clamp ring, fit to Oventrop radiator valves with female thread
- Black O-Ring, made of EPDM.



Item No.	Dimensions	G inch	l1 mm	l mm	z1 mm	Pallet/ Pack	Box/M QTY	UOM	Price per m/each
1014016	16-G1/2"MT	1/2	29,2	35,9	6,7	20	1	pce	6,57

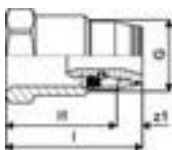

Uponor Smart Radi cover plate dividable

- Escutcheon cover made of white polypropylene
- For Uponor Uni-Pipe PLUS and MLC pipes to cover wall or floor penetrations around pipes
- Required distance between two snap rings (pipe centre - centre), e.g. for supply and return heating lines - approx. 50 mm.
- Fire class E acc. to BS EN 13501-1.



Item No.	Dimensions	di mm	do mm	h mm	Pallet/ Pack	Box/M QTY	UOM	Price per m/each
1011370	16 white	17	47	12	1350	50	pce	0,57
1011372	20 white	21	52	12	1350	50	pce	0,55

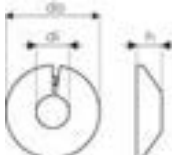

Smart Radi

Uponor Smart Radi elbow adapter plated Q&E

- With plated copper pipe 15 x 1mm - EN 1057
- Connection of the plated copper pipe can be made using a standard BS EN 1254 compression type fitting,
- or a compatible metal press connection.

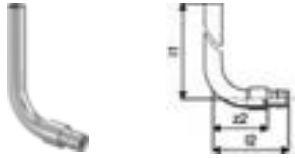

Item No.	Dimensions	l1 mm	l2 mm	z2 mm	p bar	Pallet/ Pack	Box/M QTY	UOM	Price per m/each
1023045	16-15CU l=300mm	300	65	47	6+10	40	2	pce	25,12

Uponor Smart Radi bend support

- Made of white plastic.
- For radiator connections from the floor with PE-Xa and MLC pipes in dimension 16.
- Dividable, for conduit 25/20 mm.
- Min. c/c 40 mm, including 5 mm distance.

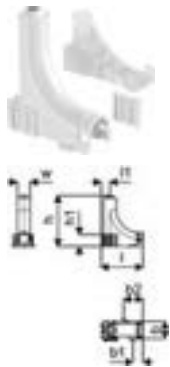

Item No.	Dimensions	l1 mm	l mm	b mm	b1 mm	b2 mm	h mm	h1 mm	w mm	Pallet/ Pack	Box/M QTY	UOM	Price per m/each
1009008	25/20mm	20,5	100	41	24	46	122	28	30	750	10	pce	10,93



Benefits

- Space saving modular system
- Innovative 'plug-in' connection between body and adapter
- Safe assembly on a work bench
- Fast and flexible: tool-free assembly, many variations
- Locking pins can be withdrawn to allow parts to separate for adjustments or changes to the system
- More efficient stock management
- Flame-free installation
- Colour coding 16 -110mm for easy dimension selection
- Inspection windows on each press sleeve
- Easy adaptations from Copper and Steel systems

Uponor RS is a unique system for riser installations and distribution lines. The highly versatile system follows a modular design principle meaning Just 40 system components enable hundreds of fitting variants.

Using a combination of adaptable fitting bodies such as tees, elbows, and couplers, any combination of the required fitting can be assembled in seconds using the innovative plug-in adapters which are secured using the special Uponor locking pins. Reductions from 110mm down to just 16mm is made using two small components, removing the need for a long sequence of reduction fittings.

All pipes can be safely pre-assembled on a suitable work surface and, once pressed, can simply be offered up and connected to the fitting assembly in situ. No need for overhead pressing of a fitting or trying to ensure enough space to provide access for pressing equipment.

Specification

- Tin-plated brass
- Fixed press sleeve with inspection windows
- Stop ring
- Colour code
- Test safety
- Male and female threads to BS EN 10226-1

Uponor RS coupling

- Made of tin-plated brass
- Base part for RS2 or RS3 adapters or fittings - includes 2 lock pins.



Item No.	Dimensions mm	l	Pallet/ Pack	Box/M QTY	UOM	Price per m/each
1029144	RS2-RS2	58	480	1	pce	27,79
1029145	RS3-RS3	58	480	1	pce	69,43

Application

Tested/approved according to BS EN ISO 21003 Multilayer piping systems for hot and cold water installations inside buildings for application class 1,2,4,5/10bar

Domestic water services: The permanent operating temperature from 20°C to 70°C at a maximum permanent operating pressure of 10 bar. The short-term malfunction temperature is 95°C for a period of 100 hours in the operating life time.

Domestic cold water services : where the water temperature does not exceed 20°C at a maximum permanent operating pressure of 16bar.

Heating: The permanent operating temperature ranges up to 80°C at a maximum permanent operating pressure of 10 bar. The short-term malfunction temperature is 100°C for a period of 100 hours in the operating life time.

Certification

UK Reg4 approval

- WRAS or
- KIWA

To meet the requirements of the Water Supply (Water Fittings) Regulations 1999

Uponor RS elbow

- Made of tin-plated brass
- Base part for RS2 or RS3 adapters or fittings - includes 2 lock pins.



Item No.	Dimensions	l1 mm	l2 mm	Pallet/ Pack	Box/M QTY	UOM	Price per m/each
1029138	RS2-RS2	51	51	336	1	pce	36,85
1029139	RS3-RS3	68	68	240	1	pce	97,97

Uponor RS elbow 45deg

- Made of tin-plated brass
- Base part for RS2 or RS3 adapters or fittings - includes 2 lock pins.



Item No.	Dimensions	l1 mm	l2 mm	Pallet/ Pack	Box/M QTY	UOM	Price per m/each
1029140	RS2-RS2	51	51	336	1	pce	43,85
1029141	RS3-RS3	68	68	175	1	pce	116,21

Uponor RS tee

- Made of tin-plated brass
- Base part for RS2 or RS3 adapters or fittings - includes 2 lock pins.

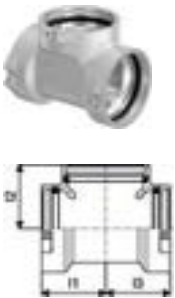

Item No.	Dimensions	l1 mm	l2 mm	l3 mm	Pallet/ Pack	Box/M QTY	UOM	Price per m/each
1029142	RS2-RS2-RS2	51	51	51	336	1	pce	48,06
1029143	RS3-RS3-RS3	68	68	68	175	1	pce	125,61

Uponor RS reducer

- Made of tin-plated brass
- RS3 to RS2 reducer - includes 1 lock pin.



Item No.	Dimensions	l1 mm	l2 mm	l mm	z1 mm	Pallet/ Pack	Box/M QTY	UOM	Price per m/each
1029146	RS3-RS2	20	19	47	8	480	1	pce	56,03

Uponor RS spacer

- Made of tin plated brass
- Spacer to connect RS base parts of equal dimensions.



Item No.	Dimensions	l1 mm	l2 mm	l mm	z1 mm	Pallet/ Pack	Box/M QTY	UOM	Price per m/each
1046750	RS2-RS2 l=5mm	20	20	45	5	480	1	pce	40,52
1046751	RS3-RS3 l=5mm	20	20	45	5	240	1	pce	64,80

Uponor RS spacer

- Made of tin-plated brass
- Spacer to connect RS base parts of equal dimensions or to create T-manifold or a cross-over in distribution lines.



Item No.	Dimensions	l1 mm	l2 mm	l3 mm	l mm	z1 mm	Pallet/ Pack	Box/M QTY	UOM	Price per m/each
1046477	RS2-RS2 l=130mm	20	20	30	170	130	240	1	pce	108,09
1046478	RS3-RS3 l=210mm	20	20	30	250	210	96	1	pce	187,09

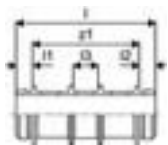

Uponor RS adapter S-Press

- Made of tin-plated brass
- Inspection windows on press sleeve
- Contoured aluminium press sleeve with colour coded breakaway press indicator
- Fits into all RS2 base parts.

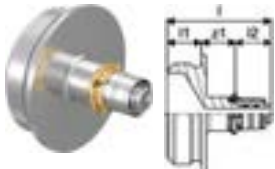

Item No.	Dimensions	l1 mm	l2 mm	l mm	z1 mm	Pallet/ Pack	Box/M QTY	UOM	Price per m/each
1059397	16-RS2	20	21	60,8	19,8	480	1	pce	34,40

Uponor RS adapter S-Press

- Made of tin-plated brass
- Inspection windows on press sleeve
- Select the adapter based on the pipe size and then select the corresponding RS2 or RS3 base part.



Item No.	Dimensions	l1 mm	l2 mm	l mm	z1 mm	Pallet/ Pack	Box/M QTY	UOM	Price per m/each
1046940	40-RS2	20	37,9	64,8	6,9	480	1	pce	30,19
1046941	50-RS2	20	37,9	64,8	6,9	480	1	pce	32,87
1029125	63-RS2	20	60,7	87,8	7,1	400	1	pce	30,47
1029126	75-RS2	20	60,7	87,8	7,1	400	1	pce	52,94
1029127	90-RS3	20	62	92,6	10,6	240	1	pce	107,98
1029128	110-RS3	20	62	92,6	10,6	240	1	pce	116,43

Uponor RS adapter S-Press PLUS

- Made of tin-plated DZR brass
- Inspection windows on press sleeve
- Press indicator foils
- Fits into all RS2 base parts.



Item No.	Dimensions	l1 mm	l2 mm	l mm	z1 mm	Pallet/ Pack	Box/M QTY	UOM	Price per m/each
1095818	20-RS2	20,1	21,3	60,9	19,5	378	1	pce	25,80
1095819	25-RS2	20,1	28,3	74,9	26,5	378	1	pce	28,31
1095820	32-RS2	20,1	28,3	74,9	26,5	378	1	pce	30,78

Uponor RS adapter male thread

- Made of tin plated brass
- Connects RS base parts RS2 or RS3 depending on connection thread size.

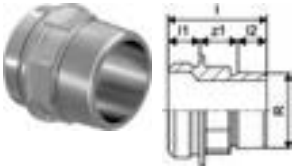

Item No.	Dimensions	l1 mm	l2 mm	l mm	R inch	z1 mm	Pallet/ Pack	Box/M QTY	UOM	Price per m/each
1029131	R2"MT-RS2	20	23,4	66	2	22,6	480	1	pce	33,95
1029132	R2 1/2"MT-RS2	20	27,1	62,8	2 1/2	15,7	480	1	pce	46,30
1029133	R3"MT-RS3	20	29,8	72,6	3	22,8	240	1	pce	69,62

Uponor RS adapter female thread

- Made of tin plated brass
- Connects RS base parts RS2 or RS3 depending on connection thread size.



Item No.	Dimensions	Rp inch	l1 mm	l2 mm	l mm	z1 mm	Pallet/ Pack	Box/M QTY	UOM	Price per m/each
1059403	Rp1/2"FT-RS2	0,5	20	15	42	7	480	1	pce	45,77
1029134	Rp1"FT-RS2	1	20	19,1	44,9	5,8	480	1	pce	28,15
1029135	Rp2"FT-RS2	2	20	25,7	54	8,3	480	1	pce	36,59
1029136	Rp2 1/2"FT-RS2	2,5	20	30,2	62,5	12,3	480	1	pce	49,06
1059404	Rp1/2"FT-RS3	0,5	20	15	43	8	336	1	pce	48,64
1029137	Rp3"FT-RS3	3	20	33,3	65,3	12	240	1	pce	69,62

Uponor RS flange adapter

- Made of tin-plated brass
- Connects to RS2 or RS3 base parts depending on the flange size or base part size
- Flange PN6/PN16 acc. to BS EN 1092-3
- Bolt circle with 4/8 holes.

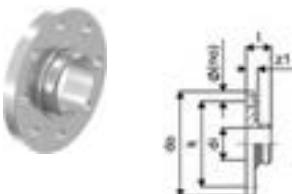

Item No.	Dimensions	di mm	l mm	do mm	k mm	z1 mm	p bar	Pallet/ Pack	Box/M QTY	UOM	Price per m/each
1059398	RS2-DN65 (PN6)	48,7	38	160	130	18	6	144	1	pce	241,37
1059399	RS2-DN65 (PN16)	48,7	45	185	145	25	16	90	1	pce	208,18
1029129	RS3-DN80 (PN16)	78,1	45	200	160	25	16	90	1	pce	218,09
1029130	RS3-DN100 (PN16)	78,1	44	220	180	24	16	90	1	pce	236,97

Uponor RS lock pin

- Made from high strength PPSU
- Used lock the RS adapters and fittings to the RS base part.



Item No.	Dimensions	L mm	W mm	H mm	W kg	Pallet/ Pack	Box/M QTY	UOM	Price per m/each
1042921	RS2 black	175	5	10	0,003	5000	10	pce	2,59
1042922	RS3 grey	280	8	8	0,004		10	pce	6,04

Compatible with:

Uni-X



Benefits

- Simple adaption from Uni-Pipe PLUS and MLC to manifolds, valves and other controls and fittings
- Flexible system design
- No special tools required

Uponor Uni-X is a range compression fittings to provide reliable connections to Uni-C manifolds, manifolds using 3/4" Eurocone connections, and for simple connections to standard compression fitting bodies to BS EN 1254-2.

Suitable for use with tap water and heating systems.

Specification

- Compression fittings with eurocone and metric connections
- Made of brass or tin-plated brass depending on variant
- Compatible with Uponor Uni Pipe PLUS and MLC pipes
- Female and male thread options according to EN ISO 228-1
- No bevel required for installation

Application

- For connection of
- drinking water systems
 - heating systems
 - radiant heating and cooling systems

Certification

- UK Reg4 approval (where applicable)
- WRAS
 - KIWA
- To meet the requirements of the Water Supply (Water Fittings) Regulations 1999

Uponor Uni-X compression adapter MLC

- Demountable and resealable compression adapter.
- Union nut and insert
- Made of brass
- For connection of Uponor Uni-Pipe PLUS and MLC pipes to manifolds
- Female thread 3/4" Eurocone according to BS EN ISO 228-1
- Pipe must be calibrated, no bevel



Item No.	Dimensions	G inch	l1 mm	l mm	z1 mm	Pallet/ Pack	Box/M QTY	UOM	Price per m/each
1058089	14-3/4"FT Euro	0,75	12,9	22,5	3,2	25	1	pce	8,92
1058090	16-3/4"FT Euro	0,75	13	22,5	3	25	1	pce	6,69
1058092	20-3/4"FT Euro	0,75	14,1	23,7	3	25	1	pce	7,86
1058093	25-3/4"FT Euro	0,75	14,1	27	6,9	25	1	pce	15,92

Uponor Uni-X compression adapter MLC NL

- Demountable and resealable compression adapter.
- Union nut and insert
- Made of brass
- For connection of Uponor Uni-Pipe PLUS and MLC pipes to radiator valves such as VSH and Bonfix
- Female thread 1/2" according to BS EN ISO 228-1
- Pipe must be calibrated, no bevel



Item No.	Dimensions	G inch	l1 mm	l mm	z1 mm	Pallet/ Pack	Box/M QTY	UOM	Price per m/each
1048100	14-15mm	G 1/2	14	22,5	2,4	25	1	pce	6,48

Uni-X

Uponor Uni-X compression adapter MLC UK

- For connection of Uni-Pipe PLUS and MLC to Uni-C manifolds
- Demountable and resealable
- Union nut and insert
- Pipe must be calibrated, no bevel



Item No.	Dimensions	G inch	l1 mm	l mm	z1 mm	Pallet/ Pack	Box/M QTY	UOM	Price per m/each
1013831	12-15mmFT	1/2	15,2	23,7	2,8	160	20	pce	8,70
1013807	20-22mmFT W1	1/8	15,2	24,2	3,5	3840	10	pce	8,26
1013808	25-28mmFT W1	1/8	23,5	36	6,9	1920	10	pce	15,64

Uponor Uni-X compression adapter plated MLC UK

- For connection of Uni-Pipe PLUS and MLC to standard compression fitting bodies to BS EN 1254-2
- Demountable and resealable
- Union nut and insert
- Pipe must be calibrated, no bevel
- Note, threads on fitting body must be checked to confirm suitable length to accommodate the necessary number of turns for the nut



Item No.	Dimensions	G inch	l1 mm	l mm	z1 mm	Pallet/ Pack	Box/M QTY	UOM	Price per m/each
1013813	12-15mmFT	1/2	15,2	23,7	3,4	7680	20	pce	7,01
1013806	16-15mmFT	1/2	16	24,9	4,3	80	20	pce	4,86

Uponor Uni-X coupling plated

- For use with Uni-X Eurocone compression adapters
- Made of tin-plated brass
- Male thread acc. to EN ISO 228-1.

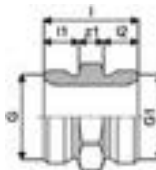

Item No.	Dimensions	G inch	G1 inch	l1 mm	l2 mm	l mm	z1 mm	Pallet/ Pack	Box/M QTY	UOM	Price per m/each
1006641	G3/4"MT Euro-G3/4"MT Euro	3/4	3/4	10	10	27	7	80	20	pce	7,85

Uponor Uni-X end plug O-ring

- For use with Uni-C manifolds
- Made of plated brass
- with sealing O-Ring.



Item No.	Dimensions	L mm	W mm	H mm	W kg	Pallet/ Pack	Box/M QTY	UOM	Price per m/each
1002273	G3/4"MT	30	30	15	0,04		50	pce	6,98









Uponor Uni-X manifold end cap, flat seal L

- For use with Uni-C manifolds
- Made of plated brass



Item No.	Dimensions	Rp inch	Pallet/ Pack	Box/M QTY	UOM	Price per m/each
1002275	G3/4"FT	3/4		50	pce	4,81
1002276	G1"FT	1	20	10	pce	5,45

Compatible with:

Item No.	Dimension	Pallet/ Pack	Box/M QTY	UOM	Price per m/each
 1141867	Uponor S-Press PLUS adapter swivel nut 16-G3/4"FT Euro	80	10	pce	21,34
 1141868	Uponor S-Press PLUS adapter swivel nut 16-G1/2"FT Uni-C	80	10	pce	16,64
 1141869	Uponor S-Press PLUS adapter swivel nut 20-G1/2"FT Uni-C	80	10	pce	19,79
 1141873	Uponor S-Press PLUS adapter swivel nut 16-G1/2"FT 15mm	80	10	pce	16,64
 1001337	Uponor Aqua PLUS manif end cap flat seal 3/4"FT	250	10	pce	6,39
 1086558	Uponor Vario ball valve 3/4-G1	10	1	set	39,14
 1059132	Uponor Vario ball valve NP G1-G1	10	1	set	53,96
 1086559	Uponor Vario ball valve, elbow Rp 3/4" - G1"		1	set	51,72

Uni-C



Benefits

- Easily adaptable to other systems
- Installation flexibility
- No special tools required

Uponor Uni-C 1/2" threaded compression manifolds made of tin-plated brass is a range of fittings and adaptors designed for tap water application.

Specification

- Modular brass manifold system with male threaded connections
- Components made of tin-plated or plated brass; brackets in galvanised steel
- Compatible with 1/2" Uni-C compression adapters for MLC and Uni Pipe PLUS pipes
- Thread standards according to EN ISO 228-1 / DIN
- System includes manifolds, valves, end caps, plugs, brackets, couplings, and adapters

Application

- Distribution and connection of tap water
- Manifold-based installations with male threaded connections
- Adaptation between Uponor pipe systems (Uni Pipe PLUS, MLC) and Uponor 1/2" threaded components
- Use in residential and light commercial installations
- Flexible system extension via manifolds, adapters, and accessories

Certification

UK Reg4 approval

- WRAS or
- KIWA

To meet the requirements of the Water Supply (Water Fittings) Regulations 1999

Uponor Uni-C screw valve

- Replacement isolation valve for Uni-C manifolds



Item No.	Dimensions	L mm	W mm	H mm	W kg	Pallet/ Pack	Box/M QTY	UOM	Price per m/each
1020248	35deg	25	25	45	0,046		10	pce	9,20

Uponor Uni-C cap valve white

- Replacement cap and service identification tag for Uni-C manifolds



Item No.	Dimensions	L mm	W mm	H mm	W kg	Pallet/ Pack	Box/M QTY	UOM	Price per m/each
1020247	35deg	26	26	24	0,007		1	pce	1,51

Uni-C

Uponor Uni-C manifold male female thread S

- Made of tin-plated brass
- With 1" male thread or female threaded ends
- 1/2" male thread outlets, compatible with Uponor compression adapters,
- and compression-free swivel-nut adapters 1141868 or 1141869

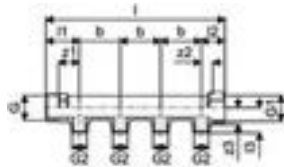

Item No.	Dimensions	G	G1	G2	l1	l2	l3	l	b	z1	z2	z3	Pallet/ Pack	Box/M QTY	UOM	Price per m/
		inch	inch	inch	mm	mm	mm	mm	mm	mm	mm	mm				
1014107	1"MT/FT 2x1/2"MT	1	1	1/2	41,5	29	30,7	120,5	50	26	14	20,8	1218	1	pce	31,53
1014111	1"MT/FT 3x1/2"MT	1	1	1/2	41,5	29	30,7	170,5	50	26	14	20,8	854	1	pce	44,73
1014109	1"MT/FT 4x1/2"MT	1	1	1/2	41,5	29	30,7	220	50	26	14	20,8	679	1	pce	56,11

Uponor Uni-C plated, with valves L, UNI

- Made of plated brass
- Valves on each circuit
- Delivered with service identification tags
- Adapters for pipe connection to be ordered separately
- Manifolds can be joined to make the required number of outlets
- With 3/4" male thread or female threaded ends
- 1/2" male thread outlets, compatible with Uponor compression adapters,
- and compression-free swivel-nut adapters 1141868 or 1141869

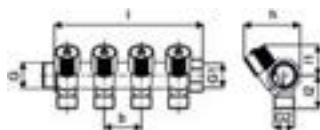

Item No.	Dimensions	G	G1	G2	l1	l2	l	b	h	Pallet/ Pack	Box/M QTY	UOM	Price per m/
		inch	inch	inch	mm	mm	mm	mm	mm				
1002280	G3/4"MT/FT 2XG1/2"MT c/c38mm	3/4	3/4	1/2	31	33,5	76	38	57,6	30	6	pce	32,93
1002281	G3/4"MT/FT 3XG1/2"MT c/c38mm	3/4	3/4	1/2	31	33,5	114	38	57,6	40	4	pce	46,52
1002282	G3/4"MT/FT 4XG1/2"MT c/c38mm	3/4	3/4	1/2	31	33,5	152	38	57,6	40	4	pce	64,75

Uni-C

Uponor Uni-C manifold bracket S

- Supplied as a single bracket
- Made of galvanised steel, for fixture of 1" Uni-C manifolds
- Sound absorbing rubber mounting
- Off-set between top and bottom rails to allow easy routing of pipework



Item No.	L mm	W mm	H mm	W kg	Pallet/ Pack	Box/M QTY	UOM	Price per m/each
1014117	305	20	63	0,288	25	1	pce	18,43

Uponor Uni-C bracket SH

- Supplied as a pair
- Made of galvanised steel, for fixture of 3/4" or 1" Uni-C manifolds
- Off-set between top and bottom rails to allow easy routing of pipework

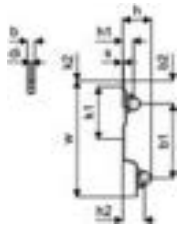

Item No.	Dimensions	s mm	b mm	b1 mm	b2 mm	h mm	h1 mm	h2 mm	k1 mm	k2 mm	w mm	Pallet/ Pack	Box/M QTY	UOM	Price per m/each
1045451	3/4" 1"	4	20	207	63	78,7	30,2	60,3	145	15,9	322	25	1	set	31,85

Uponor Uni-C end plug O-ring

- sealing element with elastomer O-ring
- designed for closing unused Uni-C connections
- resistant to drinking water and aging
- suitable for potable water installations



Item No.	Dimensions	L mm	W mm	H mm	W kg	Pallet/ Pack	Box/M QTY	UOM	Price per m/each
1002274	1"MT	20	20	40	0,1	20	10	pce	6,59

Uponor Uni-C manifold end cap female S/SH PL

- Made of plated brass
- For use to cap open outlets on Un-C manifolds, thread sealant may be required

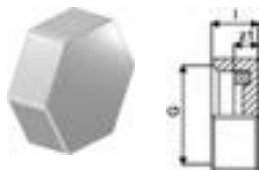

Item No.	Dimensions	G inch	l mm	z1 mm	Pallet/ Pack	Box/M QTY	UOM	Price per m/each
1014120	G1/2"FT	1/2	9,7	5	80	20	pce	5,52

Uni-C

Uponor Uni-C compression adapter MLC

- For connection of Uni-Pipe PLUS and MLC to Uni-C manifolds
- Demountable and resealable
- Union nut and insert
- Female thread 1/2" to BS EN ISO 228-1
- Pipe must be calibrated, no bevel



Item No.	Dimensions	G inch	l1 mm	l mm	z1 mm	Pallet/ Pack	Box/M QTY	UOM	Price per m/each
1058085	14-1/2"FT	0,5	13	22,5	4	25	1	pce	6,73
1058086	16-1/2"FT	0,5	13	22,5	4,2	25	1	pce	6,10
1058088	20-1/2"FT	0,5	14,1	25,7	7,3	25	1	pce	11,20





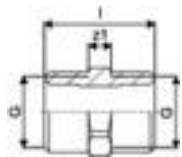

Uponor Uni-C coupling plated MLC

- Made of tin-plated brass
- Female thread acc.to BS EN ISO 228-1



Item No.	Dimensions	G inch	G1 inch	l mm	z1 mm	Pallet/ Pack	Box/M QTY	UOM	Price per m/each
1013894	1/2"MT-1/2"MT	1/2	1/2	29	6	160	40	pce	3,94

Compatible with:

Item No.	Dimension	Pallet/ Pack	Box/M QTY	UOM	Price per m/each
 1002273	Uponor Uni-X end plug O-ring G3/4"MT		50	pce	6,98
 1002275	Uponor Uni-X manifold end cap, flat seal L G3/4"FT		50	pce	4,81
 1002276	Uponor Uni-X manifold end cap, flat seal L G1"FT	20	10	pce	5,45
 1141868	Uponor S-Press PLUS adapter swivel nut 16-G1/2"FT Uni-C	80	10	pce	16,64
 1141869	Uponor S-Press PLUS adapter swivel nut 20-G1/2"FT Uni-C	80	10	pce	19,79
 1058934	Uponor Flex-X compression adapter PEX BSP 16x1,8-1/2"FT	150	10	pce	6,51

Sanipex MT



Benefits

- Hygienic design with a water-pocket-free construction and high-quality materials that meet the highest hygiene standards.
- Outstanding long-term performance is achieved through intelligent engineering, premium materials, and years of proven experience.
- Corrosion resistance is ensured by the use of high-quality gun metal and stainless-steel components.
- Extensive product portfolio with a wide range of valves and multiple jointing technologies for both hot and cold water applications.

Sanitary valves for hot and cold water distribution, control, and installation reliability - Swiss precision engineered.

Our valves and water control solutions include pressure management for safety in pipe systems, temperature management to solve the most difficult installations, and digital solutions for better monitoring and alerting.

Our installation-friendly offering we help to secure the installation, the building, and everything and everybody in it, ensure safe water supply that meets the most stringent drinking water regulations, and help prevent water waste while providing the highest comfort possible.

Specification

- Wide product range
- Gunmetal body

Application

Potable water installations

Certification

- UK Reg4 approval
- WRAS or
- KIWA

To meet the requirements of the Water Supply (Water Fittings) Regulations 1999

GF JRG Sanipex MT pipe bar

- Description: in bars
- Material: multilayer pipe PE-X/AL/PE-X
- *as long as stock last



Item No.	Item no. GF	Dimensions	d mm	DN mm	l m	Pallet/ Pack	Box/M QTY	UOM	Price per m/each
1158081	351616902	16x2,25 5m	2,25	16	5	125	5	m	POA
1158197	351620902	20x2,5 5m	2,5	20	5	80	5	m	POA
1158291	351626902	26x3 5m	3,00	26	5	45	5	m	POA
1158372	351632902	32x3 5m	3,00	32	5	35	5	m	POA
1158498	351650902	50, 5m	50	40	5	25	5	m	68,64
1158545	351663902	63, 5m	63	50	5	20	5	m	108,66

Sanipex MT

GF JRG Sanipex MT pipe in pipe coils

- in coils
- pipe in pipe



Item No.	Item no. GF	Dimensions	L mm	W mm	H mm	W kg	Pallet/ Pack	Box/M QTY	UOM	Price per m/each
1158036	351616034	16x2,25	1000	25	25	0,206	1000	50	m	POA
1158151	351620034	20x2,5	1000	29	29	0,3	50	50	m	POA

GF JRG Sanipex MT multilayer pipe PE-Xc

- Description: in coils
- Material: multilayer pipe PE-X/AL/PE-X
- *as long as stock last



Item No.	Item no. GF	Dimensions	s mm	d mm	s mm	Pallet/ Pack	Box/M QTY	UOM	Price per m/each
1158029	351612014	12x1,7 100m	1,70	12		100	100	m	POA
1158150	351620014	20x2,5 50m 10bar	2,5	20		50	50	m	POA
1158256	351626014	26x3 50m 10bar	3	26		600	50	m	POA

GF JRG Sanipex MT multilayer pipe insulated 6mm

- Description: in coils with insulation 0.035 W/mK
- Material: multilayer pipe PE-X/AL/PE-X



Item No.	Item no. GF	Dimensions	di mm	s mm	s1 mm	Pallet/ Pack	Box/M QTY	UOM	Price per m/each
1158067	351616335	16 50m	28	2,25	6	800	50	m	POA

GF JRG Sanipex MT multilayer pipe insulated 20mm

- Description: in coils with insulation 0.035 W/mK
- Material: multilayer pipe PE-X/AL/PE-X



Item No.	Item no. GF	Dimensions	di mm	s mm	s1 mm	Pallet/ Pack	Box/M QTY	UOM	Price per m/each
1158069	351616337	16 50m	56	2,25	20	250	50	m	POA
1185031	351620337	20 50m	60	2,5	20	50	0,00	m	

Sanipex MT

GF JRG Sanipex MT wall penetration single FT

- Description: JRG Sanipex MT pipes
- Material: gunmetal, plastic
- Connection: female thread, male thread, cone grip unions

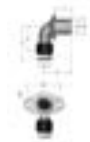

Item No.	Item no. GF	Dimensions	d1 mm	d3 inch	Rp mm	d4 mm	d5 mm	d6 inch	d mm	GN inch	l1 mm	l3 mm	l mm	z1 mm	Pallet/ Pack	Box/M QTY	UOM	Price per m/
1158115	351616950	16 25mm	16	1/2	7	50	3/4	16	1/2	51	42	25	32		10	pce	POA	
1158116	351616951	16 40mm	16	1/2	7	50	3/4	16	1/2	51	57	40	32		10	pce	POA	
1158117	351616952	16 55mm	16	1/2	7	50	3/4	16	1/2	51	72	55	32		10	pce	POA	
1158118	351616953	16 65mm	16	1/2	7	50	3/4	16	1/2	51	82	65	32		10	pce	POA	

GF JRG Sanipex MT box single 90deg

- Material: gunmetal, plastic
- Connection: female thread
- Consisting of: box body, box foot, bend, cone grip union



Item No.	Item no. GF	Dimensions	b mm	d1 inch	Rp mm	d2 mm	d3 mm	d mm	GN inch	l1 mm	l2 mm	l3 mm	z1 mm	z2 mm	z3 mm	Pallet/ Pack	Box/M QTY	UOM	Price per m/each
1158071	351616760	16x1/2"	64	1/2	25	47	16	1/2	108	42	9	36	60	24		15	pce	POA	

GF JRG Sanipex MT box single extended connection thread 90°

- Material: gunmetal, plastic
- Connection: female thread
- Consisting of: box body, box foot, bend, cone grip union, extended connection thread



Item No.	Item no. GF	Dimensions	l1 mm	l2 mm	l3 mm	d2 mm	z1 mm	z2 mm	z3 mm	Pallet/ Pack	Box/M QTY	UOM	Price per m/each
1158072	351616761	16x1/2"	108	42	9	25	36	60	24		15	pce	POA

GF JRG Sanipex MT manifold 1-fold

- Description: JRG Sanipex MT pipes
- Material: gunmetal, plastic
- Connection: loose nut, flat gasket, male thread, cone grip union

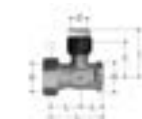

Item No.	Item no. GF	Dimensions	d1 inch	G mm	d mm	l1 mm	l2 mm	l3 mm	l5 mm	Size inch	z1 mm	z2 mm	Pallet/ Pack	Box/M QTY	UOM	Price per m/each
1158126	351616965	1x16	1	16	55	50	24	31	1	31	37		15	1	pce	POA
1158231	351620965	1x20	1	20	55	60	24	31	1	38	37		10	1	pce	POA

Sanipex MT

GF JRG Sanipex MT manifold 2-fold

- Description: JRG Sanipex MT pipes
- Material: gunmetal, plastic
- Connection: loose nut, flat gasket, male thread, cone grip union

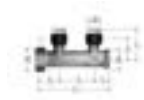

Item No.	Item no. GF	Dimensions	d1	G	d	l1	l2	l3	l4	l5	Size	z1	Pallet/ Pack	Box/M QTY	UOM	Price per m/each
1158127	351616966	2x16	1	16	110	50	24	55	31	1	31	37	15	1	pce	POA
1158232	351620966	2x20	1	20	110	60	24	55	31	1	38	37	10	1	pce	POA

GF JRG Sanipex MT manifold 3-fold

- Description: JRG Sanipex MT pipes
- Material: gunmetal, plastic
- Connection: loose nut, flat gasket, male thread, cone grip union



Item No.	Item no. GF	Dimensions	d1	G	d	l1	l2	l3	l4	l5	Size	z1	Pallet/ Pack	Box/M QTY	UOM	Price per m/each
1158128	351616967	3x16	1	16	165	50	24	55	31	1	31	37	10	1	pce	POA
1158233	351620967	3x20	1	20	165	60	24	55	31	1	38	37	10	1	pce	POA

GF JRG Sanipex MT manifold 4-fold

- Description: JRG Sanipex MT pipes
- Material: gunmetal, plastic
- Connection: loose nut, flat gasket, male thread, cone grip union



Item No.	Item no. GF	Dimensions	d1	G	d	l1	l2	l3	l4	l5	Size	z1	Pallet/ Pack	Box/M QTY	UOM	Price per m/each
1158129	351616968	4x16	1	16	220	50	24	55	31	1	31	37	10	1	pce	POA

GF JRG Sanipex MT manifold 5-fold

- Description: JRG Sanipex MT pipes
- Material: gunmetal, plastic
- Connection: loose nut, flat gasket, male thread, cone grip union



Item No.	Item no. GF	Dimensions	d1	G	d	l1	l2	l3	l4	l5	Size	z1	Pallet/ Pack	Box/M QTY	UOM	Price per m/each
1158130	351616969	5x16	1	16	275	50	24	55	31	1	31	37	20	10	pce	POA

GF JRG Sanipex MT concealed manifold

- Description: JRG Sanipex MT pipes
- Material: gunmetal, plastic
- Connection: male thread, cone grip union



Item No.	Item no. GF	Dimensions	d R	d-d-d	d1	d2	d3	d	l1	l2	l3	l4	l5	Size	z1	Pallet/ Pack	Box/M QTY	UOM	Price per m/
1158131	351616970	3x16	3/4	16 - 16 - 16	16	16	16	16	155	37	23	55	50	3/4	31	10	1	pce	POA

Sanipex MT

GF JRG Sanipex MT concealed manifold

- Description: JRG Sanipex MT pipes
- Material: gunmetal, plastic
- Connection: male thread, cone grip union

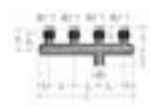

Item No.	Item no. GF	Dimensions	d R	d1	d2	d3	d4	d	l1	l2	l3	l4	l5	l6	Size	z1	z2	Pallet/ Pack	Box/M QTY	UOM	Price per m/
1158132	351616971	4x16	3/4	16	16	16	16	16	210	37	23	55	50	50	3/4	31	31	10	1	pce	POA

GF JRG Sanipex MT manifold shutt-off valve LegioStop

- Temperature: max. 90°C
- Material: gunmetal, stainless steel, EPDM, plastic
- Connection: handwheel, cone grip union
- Suitable for: 5395.320, 4640, 5419-5424, 5455



Item No.	Item no. GF	Dimensions	di	d1	d2	h	z1	z2	d4	d5	Pallet/ Pack	Box/M QTY	UOM	Price per m/each
1158323	351626975	d26	26	26	3/4	79	39	33	53	1		1	pce	POA

GF JRG Sanipex MT ball valve

- Material: gunmetal, plastic
- Temperature: max. -20°C / +95°C (water, compressed air, vacuum)
- Connection: cone grip unions



Item No.	Item no. GF	Dimensions	d1	d	DN	h	l1	l	PN	z1	z2	Pallet/ Pack	Box/M QTY	UOM	Price per m/each
1158041	351616310	d16	16	16	12	45	84	94	10	28	28		1	pce	106,99
1158154	351620310	d20	20	20	15	49	84	109	10	31	31		1	pce	118,82
1158258	351626310	d26	26	26	20	63	125	131	10	37	37		1	pce	195,84
1158345	351632310	d32	32	32	25	71	125	158	10	42	42		1	pce	234,61
1158415	351640310	d40	40	40	32	75	125	186	10	49	49		1	pce	POA

GF JRG Sanipex MT spindle extension

- Description: to 6041
- Material: aluminium



Item No.	Item no. GF	Dimensions	d	DN	h	Pallet/ Pack	Box/M QTY	UOM	Price per m/each
1158042	351616322	DN10	16 - 20	10 - 15	59		10	pce	POA
1158259	351626322	DN20-DN32	26 - 40	25 - 32	63		10	pce	69,58

Sanipex MT

GF JRG Sanipex MT ball valve spindel extension

- Material: gunmetal, stainless steel, PPSU
- Temperature: max. -20°C / +95°C (water, compressed air, vacuum)
- Connection: cone grip unions



Item No.	Item no. GF	Dimensions	di mm	l1 mm	h mm	z1 mm	z2 mm	Pallet/ Pack	Box/M QTY	UOM	Price per m/each
1158044	351616330	DN10-16	16	84	99	28	28		1	pce	POA
1158260	351626330	DN20-26	26	125	125	37	37		1	pce	220,49

GF JRG Sanipex MT tee

Description: for JRG Sanipex, JRG Sanipex MT Pipes

- Material: PPSU, PA
- Connection: cone grip union



Item No.	Item no. GF	Dimensions	d-d-d mm	d1 mm	d2 mm	d3 mm	d mm	l1 mm	l2 mm	l3 mm	z1 mm	z2 mm	z3 mm	Pallet/ Pack	Box/M QTY	UOM	Price per m/
1158094	351616921	16-16-16	16 - 16 - 16	16	16	16	16	46	46	46	27	27	27		10	pce	24,99
1158207	351620921	20-20-20	20 - 20 - 20	20	20	20	20	55	55	55	31	31	31		20	pce	26,14
1158300	351626921	26-26-26	26 - 26 - 26	26	26	26	26	68	68	68	39	39	39		10	pce	29,83
1158380	351632921	32-32-32	32 - 32 - 32	32	32	32	32	82	82	82	45	45	45		5	pce	37,25
1158441	351640921	40-40-40	40 - 40 - 40	40	40	40	40	99	99	99	55	55	55		1	pce	56,16
1158485	351650821	50-50-50	50 - 50 - 50	50	50	50	50	114	114	114	64	64	64	1	1	pce	79,56
1158534	351663821	63-63-63	63 - 63 - 63	63	63	63	63	142	142	142	79	79	79	1	1	pce	177,81

Sanipex MT

GF JRG Sanipex MT tee reduced 10bar

Description: for JRG Sanipex, JRG Sanipex MT Pipes

- Material: PPSU, PA
- Connection: cone grip union



Item No.	Item no. GF	Dimensions	d-d-d mm	d1 mm	d2 mm	d3 mm	d mm	l1 mm	l2 mm	l3 mm	z1 mm	z2 mm	z3 mm	Pallet/ Pack	Box/M QTY	UOM	Price per m/
1158210	351620924	20-16-16	20 - 16 - 16	20	16	16	20	55	48	46	31	29	27		20	pce	POA
1158212	351620926	20-16-20	20 - 16 - 20	20	16	20	20	55	48	55	31	29	31		20	pce	25,37
1158213	351620927	20-20-16	20 - 20 - 16	20	20	16	20	55	55	48	31	31	29		20	pce	POA
1158303	351626924	26-16-26	26 - 16 - 26	26	16	26	26	68	52	68	39	33	39		10	pce	32,23
1158307	351626928	26-20-20	26 - 20 - 20	26	20	20	26	68	59	55	39	35	31		15	pce	POA
1158304	351626925	26-20-26	26 - 20 - 26	26	20	26	26	68	59	68	39	35	39		10	pce	32,23
1158308	351626929	26-26-20	26 - 26 - 20	26	26	20	26	68	68	59	39	39	35		10	pce	POA
1158383	351632924	32-16-32	32 - 16 - 32	32	16	32	32	82	57	82	45	38	45		5	pce	36,47
1158387	351632928	32-20-32	32 - 20 - 32	32	20	32	32	82	64	82	45	40	45		5	pce	36,47
1158389	351632930	32-26-26	32 - 26 - 26	32	26	26	32	82	73	68	45	44	39		5	pce	POA
1158388	351632929	32-26-32	32 - 26 - 32	32	26	32	32	82	73	82	45	44	45		5	pce	36,47
1158451	351640932	40-26-32	40 - 26 - 32	40	26	32	40	99	79	82	55	50	45	1	1	pce	POA
1158448	351640928	40-26-40	40 - 26 - 40	40	26	40	40	99	79	99	55	50	55	1	1	pce	50,78
1158450	351640931	40-32-32	40 - 32 - 32	40	32	32	40	99	89	82	55	52	45	1	1	pce	POA
1158449	351640930	40-32-40	40 - 32 - 40	40	32	40	40	99	89	99	55	52	55	1	1	pce	50,78

GF JRG Sanipex MT tee reduced 10bar

- Description: to JRG Sanipex MT pipes
- Material: PPSU, PA
- Connection: cone grip union



Item No.	Item no. GF	Dimensions	d-d-d mm	d1 mm	d2 mm	d3 mm	d mm	l1 mm	l2 mm	l3 mm	z1 mm	z2 mm	z3 mm	Pallet/ Pack	Box/M QTY	UOM	Price per m/
1158491	351650827	50-26-50	50 - 26 - 50	50	26	50	50	114	75	114	63	46	63		1	pce	81,20
1158492	351650828	50-32-50	50 - 32 - 50	50	32	50	50	114	85	114	63	48	63		1	pce	POA
1158493	351650829	50-40-40	50 - 40 - 40	50	40	40	50	114	96	96	63	52	52		1	pce	POA
1158494	351650830	50-40-50	50 - 40 - 50	50	40	50	50	114	96	114	63	52	63		1	pce	81,20
1158540	351663828	63-26-63	63 - 26 - 63	63	26	63	63	142	84	142	79	55	79		1	pce	174,96
1158541	351663829	63-32-63	63 - 32 - 63	63	32	63	63	142	94	142	79	57	79		1	pce	174,96
1158542	351663830	63-40-63	63 - 40 - 63	63	40	63	63	142	104	142	79	60	79		1	pce	206,72
1158543	351663831	63-50-63	63 - 50 - 63	63	50	63	63	142	120	142	79	69	79		1	pce	203,86

Sanipex MT

GF JRG Sanipex MT tee

- Description: to JRG Sanipex MT pipes
- Material: gunmetal, plastic
- Connection: female thread, cone grip union



Item No.	Item no. GF	Dimensions	d-d mm	d1 mm	d2 inch	Rp mm	d3 mm	d mm	GN inch	l1 mm	l2 mm	l3 mm	l mm	Size inch	z1 mm	z2 mm	z3 mm	Pallet/ Pack	Box/M QTY	UOM	Price per m/
1158037	351616044	16x1/2" FT	16	16	1/2	16	16	1/2	54	27	54	108	1/2	35	12	35		5	pce	POA	
1158221	351620944	20x1/2" FT	20	20	1/2	20	20	1/2	63	28	63	125	1/2	39	13	39		5	pce	POA	
1158315	351626944	26x1/2" FT	26	26	1/2	26	26	1/2	70	34	70	149	1/2	41	19	41		5	pce	POA	
1158316	351626945	26x3/4" FT	26	26	3/4	26	26	3/4	70	34	70	149	3/4	41	18	41		5	pce	POA	
1158392	351632944	32x1/2" FT	32	32	1/2	32	32	1/2	86	34	86	172	1/2	49	19	49		5	pce	POA	
1158393	351632945	32x3/4" FT	32	32	3/4	32	32	3/4	86	34	86	182	3/4	49	18	49		5	pce	POA	

GF JRG Sanipex MT tee

- Description: to JRG Sanipex MT pipes
- Material: gunmetal, plastic
- Connection: male thread, cone grip union

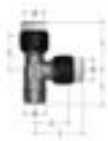

Item No.	Item no. GF	Dimensions	d-d mm	d1 inch	Rp mm	d mm	GN inch	l1 mm	l2 mm	l3 mm	Size inch	z2 mm	z3 mm	Pallet/ Pack	Box/M QTY	UOM	Price per m/
1158133	351616972	16x1/2" MT	16	1/2	16	1/2	29	44	44	1/2	26	26		10	pce	POA	
1158134	351616973	16x3/4" MT	16	3/4	16	3/4	35	44	44	3/4	26	26		10	pce	POA	
1158236	351620973	20x3/4" MT	20	3/4	20	3/4	35	52	52	3/4	30	30		10	pce	POA	

GF JRG Sanipex MT adapter with cone FT

- Description: for heating element connection
- Material: gunmetal, plastic
- Connection: female thread, gasket, insert-Eurocone, cone grip union



Item No.	Item no. GF	Dimensions	d1 mm	d2 inch	G mm	d3 mm	d mm	l1 mm	l2 mm	l3 mm	z1 mm	Pallet/ Pack	Box/M QTY	UOM	Price per m/each
1157941	351564402	16 FT	16	3/4	18	16	42	8	34	15	32		10	pce	POA
1157942	351564403	20 FT	20	3/4	18	20	47	8	39	16	32		10	pce	POA

Sanipex MT

GF JRG Sanipex MT cross-tee

- Description: for a crossover-free connection to the heating element
- Material: gunmetal, plastic
- Connection: cone grip union



Item No.	Item no. GF	Dimensions	b1 mm	b2 mm	b3 mm	d1 mm	d2 mm	d3 mm	d mm	h1 mm	l1 mm	l2 mm	l3 mm	l4 mm	l5 mm	l6 mm	Thermal conductivity W/mK	z1 mm	z2 mm	z3 mm	Pallet/ Pack	Box/M QTY	UOM	Price
1158104	351616938	16, PN10	50	95	135	16	16	16	16	50	45	45	45	45	50	160	0.035	27	27	27		1	pce	POA
1158227	351620956	20-16-16	50	95	135	20	16	16	20	50	54	45	45	45	50	160	0.035	30	27	27		1	pce	POA
1158105	351616939	20-16-20	50	95	135	20	16	20	20	50	54	45	54	54	50	160	0.035	30	27	30		1	pce	POA
1158226	351620955	20	50	95	135	20	20	20	20	50	54	54	54	54	50	160	0.035	30	30	30		1	pce	POA

GF JRG Sanipex MT unit for radiator connector

- Description: for radiator connection
- Material: pipe loop made of rigid JRG Sanipex MT pipe, PU foam insulation box



Item No.	Item no. GF	Dimensions	b1 mm	b2 mm	d1 mm	d mm	h1 mm	h2 mm	l1 mm	l2 mm	Thermal conductivity W/mK	Pallet/ Pack	Box/M QTY	UOM	Price per m/
1157945	351564801	d16	100	50	16	16	70	170	120	40	0.035	10	1	pce	POA

GF JRG Sanipex MT baseboard set

- Description: for heating element connection
- Material: gunmetal, plastic
- Connection: male thread, cone grip unions

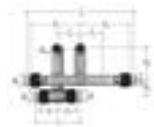

Item No.	Item no. GF	Dimensions	d-d mm	d1 mm	d2 mm	d3 mm	d4 mm	d5 mm	G inch	N inch	h1 mm	h2 mm	l1 mm	l2 mm	l3 mm	z1 mm	z2 mm	z3 mm	z4 mm	Pallet/ Pack	Box/M QTY	UOM	Price per m/
1158046	351616420	16 MT	16 - 16	16	16	16	16	16	1/2	1/2	35	70	95	50	235	29	29	99	99		1	pce	POA
1158158	351620420	20 MT	20 - 20	20	20	20	20	20	1/2	1/2	35	70	105	50	248	28	28	98	98		1	pce	POA

Sanipex MT

GF JRG Sanipex MT elbow 90deg

Description: for JRG Sanipex, JRG Sanipex MT Pipes

- Material: PPSU, PA
- Connection: cone grip union



Item No.	Item no. GF	Dimensions	d mm	l1 mm	l2 mm	z1 mm	z2 mm	Pallet/ Pack	Box/M QTY	UOM	Price per m/each
1158095	351616922	16 10bar	16	46	46	27	27		20	pce	13,89
1158208	351620922	20 10bar	20	55	55	31	31		10	pce	15,96
1158301	351626922	26 10bar	26	68	68	39	39		15	pce	22,94
1158381	351632922	32 10bar	32	82	82	45	45	40	5	pce	29,83
1158442	351640922	40 10bar	40	99	99	55	55	20	1	pce	42,62
1158486	351650822	50 10bar	50	114	114	63	63		1	pce	68,33
1158535	351663822	63 10bar	63	142	142	79	79	1	1	pce	111,63

GF JRG Sanipex MT bend with loose nut 90°

Description: for JRG Sanipex, JRG Sanipex MT Pipes

- Material: gunmetal, plastic
- Connection: cone grip union



Item No.	Item no. GF	Dimensions	a mm	b mm	d mm	l1 mm	l2 mm	z1 mm	z2 mm	Pallet/ Pack	Box/M QTY	UOM	Price per m/each
1158091	351616917	d16	73	16	16	53	46	46	27	25	10	pce	POA
1158204	351620917	d20	89	20	20	67	58	58	32	30	10	pce	POA
1158317	351626948	d26	106	26	26	80	71	67	39	36	10	pce	POA
1158395	351632963	d32	128	32	32	98	86	82	46	43	5	pce	POA
1158453	351640946	d40	150	40	40	113	103	95	56	50	1	pce	POA
1158504	351650934	d50	157	50	50	115	114	94	65	60	1	pce	POA
1158551	351663934	d63	188	63	63	138	142	110	82	70	1	pce	POA

GF JRG Sanipex MT bend 90° FT

- Description: to JRG Sanipex MT pipes
- Material: gunmetal, plastic
- Connection: female thread, cone grip union



Item No.	Item no. GF	Dimensions	d1 Rp inch	d mm	GN inch	l1 mm	l2 mm	Size inch	z1 mm	z2 mm	Pallet/ Pack	Box/M QTY	UOM	Price per m/	
1158135	351616974	d16x1/2"	1/2	16	1/2	43	33	1/2	25	17	27	50	10	pce	POA
1158092	351616918	d16x3/4"	3/8	16	3/8	46	27	3/8	27	17	25		10	pce	POA
1158237	351620974	d20x3/4"	3/4	20	3/4	56	36	3/4	30	22	32		10	pce	POA
1158205	351620918	d20x1/2"	1/2	20	1/2	55	34	1/2	31	21	30		10	pce	POA
1158318	351626949	d26x3/4"	3/4	26	3/4	68	37	3/4	39	23	36		10	pce	POA
1158396	351632964	32x1"	1	32	1	85	45	1	45	28	43		5	pce	POA
1158454	351640947	d40x 1 1/4"	1 1/4	40	1 1/4	99	50	5/4	55	31	50		1	pce	POA
1158505	351650935	d50x 1 1/2"	1 1/2	50	1 1/2	114	59	1 1/2	63	40	60		1	pce	POA
1158552	351663935	63x2"	2	63	2	142	67	2	79	44	70		1	pce	POA

Sanipex MT

GF JRG Sanipex MT bend 90° MT

Description: for JRG Sanipex, JRG Sanipex MT Pipes

- Material: gunmetal, plastic
- Connection: male thread, cone grip union



Item No.	Item no. GF	Dimensions	d1 R inch	d mm	GN inch	l1 mm	l2 mm	z1 mm	z2 mm	Pallet/ Pack	Box/M QTY	UOM	Price per m/each
1158136	351616975	d16x1/2"	1/2	16	1/2	44	31	25	18	50	10	pce	POA
1158090	351616914	d16x3/4"	3/4	16	3/4	49	35	28	18	50	10	pce	POA
1158238	351620975	d20x1/2"	1/2	20	1/2	50	33	27	21		10	pce	POA
1158239	351620976	d20x3/4"	3/4	20	3/4	52	35	30	21		10	pce	POA
1158332	351626993	d26x3/4"	3/4	26	3/4	69	54	39	27		10	pce	POA
1158405	351632994	d32x1"	1	32	1	83	60	45	32		5	pce	POA
1158464	351640994	d40x 1 1/4"	1 1/4	40	1 1/4	106	74	55	46		1	pce	POA
1158511	351650994	d50x 1 1/2"	1 1/2	50	1 1/2	111	62	60	50	1	1	pce	POA

GF JRG Sanipex MT transition bend 90°

- Description: for stainless steel / copper pipes
- Temperature: max. 90°C
- Material: gunmetal, PPSU
- Connection: push-in system sudoFIT
- Approved for the following pipe types and systems:
- (For other approvals, please contact our technical customer service).
- Stainless steel pipes / PN16 / Ø 15, 18, 22, 28, 35, 42, 54 / Mapress / Optipress, Sanpress /inoxPRES
- Copper pipes / PN10 / Ø 12, 15, 18, 22, 28, 35, 42, 54 / WICU, KME / SANCO, Wieland-Werke /SANCO, KME



Item No.	Item no. GF	Dimensions	d1 mm	d2 mm	d mm	DN	l1 mm	l2 mm	z1 mm	z2 mm	Pallet/ Pack	Box/M QTY	UOM	Price per m/each	
1157577	351060574	DN10	16	12	16	- 12	10	39	47	16	26	50	5	pce	POA
1157576	351060570	DN12	16	15	16	- 15	12	44	47	20	28	50	5	pce	POA

GF JRG Sanipex MT adapter with loose nut 90deg

- Description: to JRG Sanipex, JRG Sanipex MT pipes
- Material: gunmetal, brass, plastic
- Connection: female thread, gasket, lose nut, cone grip union



Item No.	Item no. GF	Dimensions	d1 mm	d2 inch	d mm	GN inch	l1 mm	l2 mm	Size inch	z1 mm	z2 mm	Pallet/ Pack	Box/M QTY	UOM	Price per m/each
1157934	351563023	d16	16	1/2	16	1/2	46	32	1/2	27	22		5	pce	POA

GF JRG Sanipex MT elbow 45°

- Description: to JRG Sanipex d20, JRG Sanipex MT
- Material: PPSU, PA
- Connection: cone grip union



Item No.	Item no. GF	Dimensions	d mm	l1 mm	l2 mm	z1 mm	z2 mm	Pallet/ Pack	Box/M QTY	UOM	Price per m/each
1158209	351620923	d20	20	45	45	21	21		10	pce	17,46
1158302	351626923	d26	26	56	56	27	27		20	pce	22,94
1158382	351632923	d32	32	69	69	32	32		5	pce	29,83
1158443	351640923	d40	40	81	81	37	37		1	pce	42,62
1158487	351650823	d50	50	98	98	47	47		1	pce	68,33
1158536	351663823	d63	63	119	119	56	56		1	pce	111,98

Sanipex MT

GF JRG Sanipex MT bend with loose nut 45°

Description: for JRG Sanipex, JRG Sanipex MT Pipes

- Material: PPSU, PA
- Connection: cone grip union



Item No.	Item no. GF	Dimensions	a mm	d mm	l1 mm	l2 mm	z1 mm	z2 mm	Pallet/ Pack	Box/M QTY	UOM	Price per m/each
1158319	351626950	d26	65	26	76	58	65	27 36		10	pce	POA
1158397	351632965	d32	72	32	82	72	70	32 43		5	pce	POA
1158455	351640948	d40	84	40	96	84	82	37 50		1	pce	POA
1158506	351650936	d50	90	50	98	98	80	48 60		1	pce	POA
1158553	351663936	d63	111	63	121	119	101	57 70		1	pce	POA

GF JRG Sanipex MT elbow 45° FT

- Description: to JRG Sanipex MT pipes
- Material: gunmetal, plastic
- Connection: female thread, cone grip union



Item No.	Item no. GF	Dimensions	d3	d mm	GN inch	l1 mm	l2 mm	Size inch	z1 mm	z2 mm	Pallet/ Pack	Box/M QTY	UOM	Price per m/
1158320	351626951	d26	3/4	26	3/4	58	35	3/4	27	21 36		5	pce	POA
1158398	351632966	d32	1	32	1	72	32	1	32	15 43		5	pce	POA
1158456	351640949	d40	1 1/4	40	5/4	84	37	5/4	37	18 50		1	pce	POA
1158507	351650937	d50	1 1/2	50	1 1/2	98	42	1 1/2	48	23 60		1	pce	POA
1158554	351663937	d63	2	63	2	119	50	2	57	27 70		1	pce	POA

GF JRG Sanipex MT coupler

- Description: to JRG Sanipex MT pipes
- Material: PPSU, PA
- Connection: cone grip union



Item No.	Item no. GF	Dimensions	d mm	l1 mm	z1 mm	Pallet/ Pack	Box/M QTY	UOM	Price per m/each
1158093	351616920	d16	16	76	37		20	pce	10,57
1158206	351620920	d20	20	90	42		10	pce	12,45
1158299	351626920	d26	26	108	50		20	pce	21,10
1158379	351632920	d32	32	127	53		5	pce	20,87
1158440	351640920	d40	40	150	62		1	pce	33,92
1158484	351650820	d50	50	166	64	1	1	pce	47,10
1158533	351663820	d63	63	205	79		1	pce	93,72

Sanipex MT

GF JRG Sanipex MT double union

- Description: to JRG Sanipex MT components
- Material: plastic
- Connection: cone grip union



Item No.	Item no. GF	Dimensions	L mm	W mm	H mm	W kg	Pallet/ Pack	Box/M QTY	UOM	Price per m/each
1158106	351616940	16 10bar	50	25	25	0,019	50	10	pce	POA
1158217	351620940	20 10bar	70	35	35	0,031		10	pce	POA
1158311	351626940	26 10bar	80	40	40	0,06		10	pce	POA
1158390	351632940	32 10bar	100	50	50	0,108		5	pce	POA
1158452	351640940	40 10bar	125	60	60	0,19		5	pce	POA
1158508	351650940	50 10bar	150	80	80	0,33	1	1	pce	POA
1158555	351663940	63 10bar	187	96	96	0,61	1	1	pce	POA

GF JRG Sanipex MT cap 10bar

- Description: to JRG Sanipex MT components
- Material: PPSU
- Connection: cone grip union



Item No.	Item no. GF	Dimensions	L mm	W mm	H mm	W kg	Pallet/ Pack	Box/M QTY	UOM	Price per m/each
1158082	351616904	16 10bar	20	20	17	0,002		10	pce	POA
1158198	351620904	20 10bar	25	25	20	0,003		10	pce	POA
1158292	351626904	26 10bar	32	32	25	0,007		10	pce	POA
1158373	351632904	32 10bar	40	40	30	0,012		10	pce	POA
1158434	351640904	40 10bar	50	50	35	0,02		10	pce	POA

GF JRG Sanipex MT cap 10bar

- Description: to JRG Sanipex MT components
- Material: gunmetal
- Connection: cone grip union



Item No.	Item no. GF	Dimensions	L mm	W mm	H mm	W kg	Pallet/ Pack	Box/M QTY	UOM	Price per m/each
1158499	351650904	50 10bar	55	55	18	0,14		1	pce	POA
1158546	351663904	63 10bar	70	70	22	0,275		1	pce	POA

GF JRG Sanipex MT adapter, connecting nut MT

- Description: to JRG Sanipex MT components
- Material: gunmetal, plastic
- Connection: male thread, cone grip union



Item No.	Item no. GF	Dimensions	d1 mm	d2 inch	R mm	d inch	GN inch	l1 mm	z1 mm	Pallet/ Pack	Box/M QTY	UOM	Price per m/each
1158214	351620931	20x1/2"	20	1/2	20	1/2	59	34	18		1	pce	POA
1158322	351626960	26x3/4"	26	3/4	26	3/4	70	41	23	1	1	pce	POA

Sanipex MT

GF JRG Sanipex MT adapter

- Description: for JRG Sanipex MT fittings
- Material: red brass, plastic
- Connection: external thread, flanged screw connection



Item No.	Item no. GF	In/Out	Dimensions	l1 mm	d2 mm	z1 mm	Pallet/ Pack	Box/M QTY	UOM	Price per m/each
1158325	351626983		26x1/2" MT	55	32	42		1	pce	POA
1158459	351640983	12.26	40x1" MT	78	49	59		1	pce	POA
1158401	351632984	12.26	32x1/2" MT	62	39	49		1	pce	POA
1158399	351632982		32x3/4" MT	65	39	50		1	pce	POA
1158462	351640987	12.26	40x1/2" MT	69	49	56		1	pce	POA
1158458	351640982	12.26	40x3/4" MT	72	49	57		1	pce	POA

GF JRG Sanipex MT adapter FT

- Description: to JRG Sanipex MT components
- Material: gunmetal, plastic
- Connection: female thread, cone grip union



Item No.	Item no. GF	In/Out	Dimensions	d2 mm	d mm	GN inch	l1 mm	z1 mm	Pallet/ Pack	Box/M QTY	UOM	Price per m/each
1158310	351626933	12.26	d26	32	26	1/2	39	24 24		1	pce	POA
1158324	351626982		26x3/8"	32	26	3/8	39	27 24		1	pce	POA
1158400	351632983		32x1/2"	39	32	1/2	47	34 27		1	pce	POA
1158460	351640984	12.26	40x1/2"	49	40	1/2	54	40 27		1	pce	POA
1158461	351640985	12.26	40x3/4"	49	40	3/4	55	40 32		1	pce	POA

Sanipex MT

GF JRG Sanipex MT transition union

Description: for JRG Sanipex, JRG Sanipex MT Pipes

- Material: gunmetal, plastic
- Not suitable for direct connection to water meters, as replacement only possible with JRG Sanipex MT ratchet torque wrench.

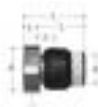

Item No.	Item no. GF	Dimensions	d1 G inch	d GN mm inch	l1 mm	l2 mm	l3 mm	z1 mm	mm	Pallet/ Pack	Box/M QTY	UOM	Price per m/
1158141	351616992	16x1/2"	1/2	16 1/2	43.0	6.0	37.0	16.5	27		10	pce	POA
1158051	351616562	16-DN15									1	pce	POA
1158143	351616994	16x3/4"	3/4	16 3/4	39.0	6.0	33.0	14.5	32		10	pce	POA
1158103	351616936	16x1"	1	16 1	42.5	7.0	35.5	22.5	37		10	pce	POA
1158144	351616996	16x1 1/4"	1 1/4	16 1 1/4	41.0	8.0	33.0	14.5	46		1	pce	POA
1158234	351620968	20x1/2"	1/2	20 1/2	50.0	6.0	44.0	17.5	27		10	pce	POA
1158245	351620992	20x3/4"	3/4	20 3/4	44.0	6.0	38.0	15.5	32		10	pce	POA
1158216	351620936	20x1"	1	20 1	49.0	7.0	42.0	20.5	37		10	pce	POA
1158246	351620994	20x1 1/4"	1 1/4	20 1 1/4	46.0	8.0	38.0	15.5	46		1	pce	POA
1158298	351626919	26x3/4"	3/4	26 3/4	57.0	6.0	49.0	20.0	32		5	pce	41,10
1158333	351626994	26x1"	1	26 1	54.5	7.0	47.5	18.5	37		5	pce	POA
1158334	351626995	26x1 1/4"	1 1/4	26 1 1/4	55.5	8.0	47.5	18.5	46		1	pce	POA
1158335	351626996	26x1 1/2"	1 1/2	26 1 1/2	56.5	9.0	47.5	18.5	54		1	pce	POA
1158406	351632995	32x1 1/4"	1 1/4	32 1 1/4	65.5	8.0	57.5	19.5	46		1	pce	POA
1158407	351632996	32x1 1/2"	1 1/2	32 1 1/2	66.5	9.0	57.5	19.5	54		1	pce	POA
1158465	351640995	40x1 1/2"	1 1/2	40 1 1/2	77.5	9.0	68.5	23.5	55		1	pce	POA
1158466	351640996	40x2"	2	40 2	82.5	13.5	69.0	24.5	67		1	pce	POA
1158512	351650995	50x1 3/4"	1 3/4	50 1 3/4	81.5	10.0	71.5	33.0	60		1	pce	POA
1158513	351650996	50x2 1/4"	2 1/4	50 2 1/4	82.5	11.0	71.5	34.0	72		1	pce	POA
1158559	351663995	63x2 3/8"	2 3/8	63 2 3/8	99.5	11.0	88.5	39.0	78	1	1	pce	POA
1158560	351663996	63x2 3/4"	2 3/4	63 2 3/4	100.0	13.5	86.5	40.0	89	1	1	pce	POA

GF JRG Sanipex MT transition

- Description: to JRG Sanipex d20, JRG Sanipex MT
- Material: gunmetal, plastic
- Connection: male thread, cone grip union



Item No.	Item no. GF	Dimensions	d1 G inch	d mm	l2 mm	z1 mm	mm	Pallet/ Pack	Box/M QTY	UOM	Price per m/each
1158242	351620989	20x1"	1	20	58	35	30		10	pce	POA
1158330	351626991	26x1"	1	26	68	39	30		5	pce	POA
1158404	351632993	32x1"	1	32	78	38	30		5	pce	POA

GF JRG Sanipex MT transition bend radiator connection

- Description: for radiator mounting
- Material: copper, brass, nickel-plated
- Connection: cone grip union



Item No.	Item no. GF	Dimensions	d-d mm	d1 mm	d2 mm	l mm	r mm	Suitable for z mm	Pallet/ Pack	Box/M QTY	UOM	Price per m/each
1158137	351616983	16/15	16 - 15	16	15	300	38	d16 - d15	72	1	pce	POA

Sanipex MT

GF JRG Sanipex MT transition MT

Description: for JRG Sanipex, JRG Sanipex MT Pipes

- Material: gunmetal, plastic
- Connection: male thread, cone grip union



Item No.	Item no. GF	Dimensions	d1 R inch	d1 mm	d mm	GN inch	l1 mm	z1 mm	mm	Pallet/ Pack	Box/M QTY	UOM	Price per m/each
1158215	351620933	16x3/4"	3/4	16	16	3/4	57	37	21	50	10	pce	38,37
1158145	351616997	16x1/2"	1/2	16	16	1/2	50	31	21	50	10	pce	21,60
1158247	351620995	20x1/2" MT	1/2	20	20	1/2	59	36	21	50	10	pce	24,58
1158248	351620996	20x3/4" MT	3/4	20	20	3/4	60	37	21	50	10	pce	25,02
1158336	351626997	26x3/4" MT	3/4	26	26	3/4	74	44	27		5	pce	36,44
1158328	351626987	26x1" MT	1	26	26	1	77	47	30		5	pce	35,20
1158408	351632997	32x1" MT	1	32	32	1	88	50	32		5	pce	43,36
1158467	351640997	40x1 1/4" MT	1 1/4	40	40	1 1/4	103	58	46		1	pce	46,22
1158514	351650997	50x1 1/2" MT	1 1/2	50	50	1 1/2	118	67	50	1	1	pce	110,77
1158561	351663997	63x2" MT	2	63	63	2	143	80	65	1	1	pce	169,96

GF JRG Sanipex MT transition

Description: for JRG Sanipex, JRG Sanipex MT Pipes

- Material: gunmetal, plastic
- Connection: female thread, cone grip union



Item No.	Item no. GF	Dimensions	d1 R inch	d mm	GN inch	l1 mm	z1 mm	mm	Pallet/ Pack	Box/M QTY	UOM	Price per m/each
1158146	351616998	16x1/2" FT	1/2	16	1/2	47	15	27		10	pce	20,90
1158249	351620997	20x1/2" FT	1/2	20	1/2	51	15	27		10	pce	24,58
1158250	351620998	20x3/4" FT	3/4	20	3/4	54	17	32		5	pce	24,58
1158337	351626998	26x3/4" FT	3/4	26	3/4	61	17	32		5	pce	35,98
1158329	351626988	26x1/2" FT	1/2	26	1/2	64	16	27	50	5	pce	30,01
1158326	351626984	26x1" FT	1	26	1	67	20	41		5	pce	35,98
1158409	351632998	32x1" FT	1	32	1	74	19	41		5	pce	44,59
1158468	351640998	40x1 1/4" FT	1 1/4	40	1 1/4	86	22	50		1	pce	46,66
1158515	351650998	50x1 1/2" FT	1 1/2	50	1 1/2	95	28	55	1	1	pce	112,92
1158562	351663998	63x2" FT	2	63	2	115	33	70	1	1	pce	174,88

GF JRG Sanipex MT adapter

- Material: gunmetal, brass, plastic
- Connection: cone grip union



Item No.	Item no. GF	Dimensions	d1 mm	d2 mm	d mm	l1 mm	z1 mm	mm	Pallet/ Pack	Box/M QTY	UOM	Price per m/each	
1158140	351616990	d16	16	12	16	-12	54	34	13		5	pce	POA

Sanipex MT

GF JRG Sanipex MT adapter for push connection sudoFIT

- Description: for stainless steel / copper pipes
- Temperature: max. 90°C
- Material: gunmetal, PPSU
- Connection: push-in system sudoFIT
- Permissible tubes can be found in the installation instructions for the fitter's toolkit JRG code 8130.000
- Approved for the following pipe types and systems: (For other approvals, please contact our technical customer service).
- Stainless steel pipes / PN16 / Ø 15, 18, 22, 28, 35, 42, 54 / Mapress / Optipress, Sanpress /inoxPRES
- Copper pipes / PN10 / Ø 12, 15, 18, 22, 28, 35, 42, 54 / WICU, KME / SANCO, Wieland-Werke /SANCO, KME



Item No.	Item no. GF	Dimensions	d1 mm	d2 mm	d mm	DN mm	l1 mm	z1 mm	Pallet/ Pack	Box/M QTY	UOM	Price per m/each
1157570	351060501	d16-15	16	15	16	- 15	12	62	21	1	pce	POA
1157572	351060516	d20-18	20	22	20	- 22	15	82	25	1	pce	POA
1157571	351060511	d20-22	20	18	20	- 18	15	76	24	1	pce	POA
1157573	351060521	d26-22	26	22	26	- 22	20	75	15	1	pce	POA
1157574	351060531	d32-28	32	28	32	- 28	25	93	14	1	pce	POA
1157575	351060541	d40-35	40	35	40	- 35	32	107	16	1	pce	POA

GF JRG Sanipex MT transition press-fit end

Description: for JRG Sanipex, JRG Sanipex MT Pipes

- Material: gunmetal, plastic
- Connection: cone grip union

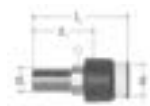

Item No.	Item no. GF	Dimensions	d1 mm	d mm	l1 mm	z1 mm	Pallet/ Pack	Box/M QTY	UOM	Price per m/each	
1158099	351616926	DN12-16	12	16	60	39	16	20	1	pce	POA
1158097	351616924	DN15-16	15	16	65	45	16	20	1	pce	POA
1158098	351616925	DN18-16	18	16	65	45	18	20	1	pce	POA
1158218	351620941	DN18-20	18	20	74	48	20	20	1	pce	POA
1158219	351620942	DN22-20	22	20	75	49	22	20	1	pce	POA
1158312	351626941	DN22-26	22	26	85	53	27	20	1	pce	POA
1158313	351626942	DN28-26	28	26	86	54	30	20	1	pce	POA

GF JRG Sanipex MT transition push nipple MF

- Description: Compatible to GEBERIT male thread MF 1/2"
- Material: gunmetal
- Connection: loose nut, cone grip union



Item No.	Item no. GF	Dimensions	d1 mm	d2 inch	Rp mm	d mm	l mm	ST inch	z mm	Pallet/ Pack	Box/M QTY	UOM	Price per m/each
1158139	351616989	16	16	1/2	16	64	1/2	46	18	5	5	pce	POA
1158241	351620987	20	20	1/2	20	74	1/2	51	21	5	5	pce	POA

Sanipex MT

GF JRG Sanipex MT reduction

Description: for JRG Sanipex, JRG Sanipex MT Pipes

- Material: PPSU, PA

-Connection: cone grip union



Item No.	Item no. GF	Dimensions	d1 mm	d mm	l1 mm	Size inch	z1 mm	Pallet/ Pack	Box/M QTY	UOM	Price per m/each
1158211	351620925	20-16 10bar	20	16	58.0	20	31		1	pce	12,24
1158305	351626926	26-16 10bar	26	16	70.5	20	41	10	1	pce	14,30
1158306	351626927	26-20 10bar	26	20	74.0	26	39		10	pce	14,30
1158384	351632925	32-16 10bar	32	16	82.0	32	52		1	pce	21,76
1158385	351632926	32-20 10bar	32	20	87.0	32	50		1	pce	20,87
1158386	351632927	32-26 10bar	32	26	92.0	32	50		1	pce	20,87
1158444	351640924	40-16 10bar	40	16	94.0	40	61		1	pce	27,89
1158445	351640925	40-20 10bar	40	20	100.0	40	61		1	pce	37,25
1158446	351640926	40-26 10bar	40	26	105.0	40	61		1	pce	36,88
1158447	351640927	40-32 10bar	40	32	111.0	40	58		1	pce	37,25
1158488	351650824	50-26 10bar	50	26	110.0	50	57		1	pce	57,78
1158489	351650825	50-32 10bar	50	32	118.0	50	58		1	pce	60,72
1158490	351650826	50-40 10bar	50	40	128.0	50	59		1	pce	60,72
1158537	351663825	63-32 10bar	63	32	134.0	63	67		1	pce	108,24
1158538	351663826	63-40 10bar	63	40	145.0	63	71		1	pce	111,15
1158539	351663827	63-50 10bar	63	50	158.0	63	77		1	pce	94,07

GF JRG fitting connector single FT

- Description: to JRG Sanipex, JRG Sanipex MT pipes

- Material: gunmetal, plastic

- Connection: female thread, cone grip union

- Suitable for: 1157845, 1157849, 1157844

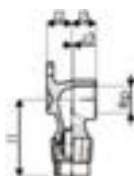

Item No.	Item no. GF	In/Out	Dimensions	Rp inch	di mm	l1 mm	l2 mm	l3 mm	do mm	d mm	k mm	z1 mm	z2 mm	z3 mm	Pallet/ Pack	Box/M QTY	UOM	Price per m/
1162627	351641601	NEW	16x1/2"/35mm	1/2	16	49	17	16,5	16		40	31		3		10	pce	POA
1185587	351641602	NEW	16x1/2"/50mm	1/2"	16	49	17	33	15,4		40	31		18	50	10	pce	POA
1185591	356141603	NEW	16x1/2"/80mm	1/2"	16	49	17,5	63	16		40	31		18	30	10	pce	POA
1185589	351642001	NEW	20x1/2"/35mm	1/2"	20	57	17,5	17,5	20		40	33		4	50	1	pce	

Sanipex MT

GF JRG Sanipex MT fitting connector single int. coated single FT

- Description: JRG Sanipex MT pipes
- Temperature: max. 30°C
- Material: gunmetal, plastic
- Connection: female thread, cone grip union
- Suitable for: 5409.010, 5409.012, 4610.090



Item No.	Item no. GF	Dimensions	d1 mm	d3 inch	Rp mm	d4 mm	d5 mm	d mm	GN inch	l1 mm	l3 mm	l4 mm	l5 mm	l6 mm	l mm	z1 mm	Pallet/ Pack	Box/M QTY	UOM	Price per m/
1158054	351616593	16x1/2"	16	1/2	7	49	16	1/2	49	35	17	15	20	35	31	10	1	1	pce	POA
1158166	351620590	20x1/2"	20	1/2	7	52	20	1/2	52	35	17	15	20	35	30	30	1	1	pce	POA

GF JRG Sanipex MT fitting connector double FT

- Description: JRG Sanipex MT pipes
- Material: gunmetal, plastic
- Connection: female thread, cone grip union
- Suitable for: 1157845, 1157849, 1157844



Item No.	Item no. GF	In/Out	Dimensions	Rp inch	l1 mm	l2 mm	l3 mm	do mm	b mm	k mm	z1 mm	z2 mm	z4 mm	Pallet/ Pack	Box/M QTY	UOM	Price per m/
1185592	351616845	NEW	16x1/2"/50mm	1/2"	56	56	17	15,4	40	40	38	38	13	30	5	pce	POA
1185593	351616846	NEW	16x1/2"/80mm	1/2"	56	56	17	15,4	40	40	38	38	13	15	5	pce	POA
1185594	351620848	NEW	20x1/2"/50mm	1/2"	68	68	17,5	19,8	50	40	45	45	12,5	15	5	pce	POA
1185595	351626848	NEW	26x1/2"/50mm	1/2"	76	76	22	26	50	40	46	46	8	10	2	pce	POA

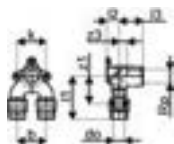

GF JRG Sanipex MT box double 90deg

- Material: gunmetal, plastic
- Connection: female thread
- Consisting of: box body, box foot, bend, cone grip union



Item No.	Item no. GF	Dimensions	b mm	d-d mm	d1 inch	Rp mm	d2 mm	d3 mm	d5 mm	GN inch	l1 mm	l2 mm	l3 mm	z1 mm	z2 mm	z3 mm	z4 mm	z5 mm	Pallet/ Pack	Box/M QTY	UOM	Price per m/
1158073	351616764	16	100	16 - 16	1/2	25	25	47	1/2	134	42	9	68	60	68	60	21		10	10	pce	POA

Sanipex MT

GF JRG Sanipex MT box double reduced 90deg

- Material: gunmetal, plastic
- Connection: female thread
- Consisting of: box body, box foot, bend, cone grip union



Item No.	Item no. GF	Dimensions	b mm	d-d mm	d1 inch	Rp mm	d2 mm	d3 mm	d5 mm	GN inch	l1 mm	l2 mm	l3 mm	z1 mm	z2 mm	z3 mm	z4 mm	z5 mm	Pallet/ Pack	Box/M QTY	UOM	Price per m/
1158188	351620762	20-16	100	20	1/2	29	25	47	1/2	134	42	9	73	50	73	50	21		10	pce	POA	

GF JRG Sanipex MT Flange adapter set

- Material: gunmetal, PPSU
- Connection: JRG Sanipex MT - Flange

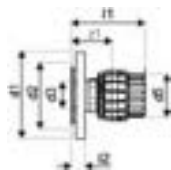

Item No.	Item no. GF	Dimensions	L mm	W mm	H mm	W kg	Pallet/ Pack	Box/M QTY	UOM	Price per m/each
1163237	351632500	DN25-d32	105	115	115	1,04		1	pce	POA
1163238	351640500	DN32-d40	122	140	140	1,49		1	pce	POA
1163301	351650500	DN40-d50	150	150	150	1,92		1	pce	POA
1163302	351663500	DN50-d63	180	160	160	3,12		1	pce	POA

GF JRG Sanipex MT fitters toolkit

- Material: plastic
- Consisting of: Expanding mandrel ML pipes: 4804.116 d16; 4804.120 d20, 4804.126 d26, 4804.132 d32 Expanding mandrel PEX pipes: 4804.216 d16, 4804.220 d20, 4804.225 d25 Clamping jaws ML / PEX pipes: 4805.016 d16, 4805.020 d20 Clamping jaws PEX pipes: 4805.026 d26, 4805.032 d32 Clamping jaws PEX pipes: 4805.125 d25 /// 4805.000 Expanding pliers, 4806.016 Hand bending template d16, 4806.026 Hand bending template d20, 4806.026 Hand bending template d26, 4832.016 Ratchet torque wrench d16, 4832.020 Ratchet torque wrench d20, 4832.026 Ratchet torque wrench d26, 4832.032 Ratchet torque wrench d32, 4834.016 Counter key d16, 4834.020 Counter key d20, 4834.026 Counter key d26, 4834.032 Counter key d32, 4836.000 Pipe cutter d16-d40, 4837.000 Multi-purpose cutter d16+d20, 4838.000 Marking pen yellow



Item No.	Item no. GF	Dimensions	b mm	d-d mm	h mm	l mm	Suitable for	Pallet/ Pack	Box/M QTY	UOM	Price per m/each
1157983	351600098	16-32	125	16	32	420	500 d16 - d32		1	pce	5 591,11

GF JRG Sanipex MT clamping jaws dovetail

Description: for JRG Sanipex, JRG Sanipex MT Pipes

- Material: steel
- Suitable for: expanding pliers



Item No.	Item no. GF	Dimensions	b mm	d mm	h mm	l mm	Pallet/ Pack	Box/M QTY	UOM	Price per m/each
1157991	351600494	16	30	16	45	35		1	pce	POA
1157992	351600495	20	30	20	45	35		1	pce	POA
1157990	351600489	26	30	26	45	35		1	pce	POA

Sanipex MT

GF JRG Sanipex MT expanding mandrel ML pipe

- Material: aluminium, steel



Item No.	Item no. GF	Dimensions	d1 mm	d2 mm	d mm	l mm	Pallet/ Pack	Box/M QTY	UOM	Price per m/each
1157993	351600496	16	10	23	16	35		1	pce	POA
1157994	351600497	20	14	23	20	34		1	pce	POA
1157989	351600488	26	18	23	26	32		1	pce	POA

GF JRG Sanipex MT expanding mandrel PE-X pipe

- Material: aluminium, steel



Item No.	Item no. GF	Dimensions	d1 mm	d2 mm	d mm	l mm	Pallet/ Pack	Box/M QTY	UOM	Price per m/each
1157995	351600498	16	11	23	16	35		1	pce	POA
1157996	351600499	20	14	23	20	33		1	pce	POA

GF JRG Sanipex MT hand bending tool

- Material: aluminium



Item No.	Item no. GF	Dimensions	L mm	W mm	H mm	W kg	Pallet/ Pack	Box/M QTY	UOM	Price per m/each
1158085	351616907	d16	200	80	30	0,2		1	pce	29,80
1158201	351620907	d20	269	118	31	0,32		1	pce	35,22
1158295	351626907	d26	415	154	39	0,775		1	pce	87,07

GF JRG Sanipex MT hand bending tool

- Material: plastic



Item No.	Item no. GF	Dimensions	b mm	d mm	h mm	l mm	Suitable for	Pallet/ Pack	Box/M QTY	UOM	Price per m/each
1157981	351600092	d16+20	102	16 / 20	310	390	d16 + d20		1	pce	1 102,12

GF JRG Sanipex MT battery hydraulic unit

- Description: expanding- and bending tool d16 - 63 / 230 V, 650 Watt, 50 Hz
 - Consisting of: Hydraulic unit, battery, charger, bag



Item No.	Item no. GF	Dimensions	b mm	h mm	l mm	Plug	Pallet/ Pack	Box/M QTY	UOM	Price per m/each
1158027	351600912	16-63 EU + CH	186	236	290	EU + CH		1	pce	8 960,95

GF JRG Sanipex MT fitters toolkit

- Material: plastic
 - Consisting of: 4828.001 Fitter's toolkit, 4830.026 Expanding unit d26, 4832.032 Expanding unit d32, 4830.040 Expanding unit d40, 4832.026 Ratchet torque wrench d26, 4832.032 Ratchet torque wrench d32, 4832.040 Ratchet torque wrench d40, 4834.026 Counter key d26, 4834.032 Counter key d32, 4834.040 Counter key d40, 4836.000 Pipe cutter



Item No.	Item no. GF	Dimensions	b mm	d mm	h mm	l mm	Suitable for	Pallet/ Pack	Box/M QTY	UOM	Price per m/each
1157982	351600094	26-40	206	26 - 40	472	575	d26 - 40		1	pce	POA

Sanipex MT

GF JRG Sanipex MT fitters toolkit

- Material: plastic
- Consisting of: 4831.000 Operating cylinder, 4831.050 Clamp unit d50, 4831.063 Clamp unit d63, 4831.350 Expanding mandrel d50, 4831.363 Expanding mandrel d63, 4832.050 Ratchet torque wrench d50, 4832.063 Ratchet torque wrench d63, 4834.050 Counter key d50, 4834.063 Counter key d63, 4836.100 Pipe cutter d50+d63



Item No.	Item no. GF	Dimensions	b mm	d mm	h mm	l mm	Suitable for	Pallet/ Pack	Box/M QTY	UOM	Price per m/each
1157968	351600007	50+63	206	50 - 63	472	575	d50 + d63		1	pce	2 647,62

GF JRG Sanipex MT expanding unit

- Description: to 4812
- Material: aluminium, steel, plastic

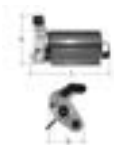

Item No.	Item no. GF	Dimensions	b mm	d mm	l mm	Pallet/ Pack	Box/M QTY	UOM	Price per m/each
1158253	351626008	d26	99	26	196		1	pce	POA
1158339	351632008	d32	99	32	201		1	pce	POA
1158411	351640008	d40	107	40	222		1	pce	POA

GF JRG Sanipex MT operating cylinder ML pipe

- Description: to 4831.050 / .063
- Material: aluminium, steel

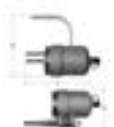

Item No.	Item no. GF	Dimensions	b mm	d mm	h mm	l mm	Pallet/ Pack	Box/M QTY	UOM	Price per m/each
1158006	351600628	50-63	201	50 - 63	130	244		1	pce	POA

GF JRG Sanipex MT expanding head

- Description: to 4831.000
- Material: aluminium



Item No.	Item no. GF	Dimensions	d1 mm	d2 mm	d mm	l1 mm	l mm	Pallet/ Pack	Box/M QTY	UOM	Price per m/each
1158470	351650108	50	40	52	50	11	40	1	1	pce	POA
1158517	351663108	63	52	65	63	11	37		1	pce	POA

GF JRG Sanipex MT clamp unit

- Description: to 4831.000
- Material: aluminium, steel



Item No.	Item no. GF	Dimensions	b mm	d mm	h mm	l mm	Pallet/ Pack	Box/M QTY	UOM	Price per m/each
1158471	351650131	d50	243	50	160	87		1	pce	POA
1158518	351663131	d63	243	63	160	87		1	pce	POA

Sanipex MT

GF JRG Sanipex MT ratchet torque wrench

- Material: aluminium, steel



Item No.	Item no. GF	Dimensions	b mm	d mm	l mm	Pallet/ Pack	Box/M QTY	UOM	Price per m/each
1158039	351616220	d16	34	16	157		1	pce	POA
1158153	351620220	d20	41	20	174		1	pce	POA
1158254	351626009	d26	51	26	224		1	pce	POA
1158340	351632009	d32	61	32	271		1	pce	POA
1158412	351640009	d40	76	40	326		1	pce	POA
1158469	351650009	d50	102	50	379		1	pce	POA
1158516	351663009	d63	130	63	442		1	pce	POA

GF JRG Sanipex MT counter key

- Material: steel



Item No.	Item no. GF	Dimensions	b mm	d mm	l mm	Pallet/ Pack	Box/M QTY	UOM	Price per m/each
1158034	351616010	d16	27	16	157		1	pce	POA
1158149	351620010	d20	33	20	174		1	pce	POA
1158255	351626010	d26	42	26	224		1	pce	POA
1158341	351632010	d32	52	32	271		1	pce	POA
1158413	351640010	d40	65	40	326		1	pce	POA
1158472	351650210	d50	102	50	405		1	pce	POA
1158519	351663210	d63	127	63	453		1	pce	POA

GF JRG Sanipex MT pipe cutter

- Material: aluminium

- Consisting of: cutting wheel (355578110)



Item No.	Item no. GF	Dimensions	L mm	W mm	H mm	W kg	Pallet/ Pack	Box/M QTY	UOM	Price per m/each
1157987	351600310	d16-40	245	136	36	0,64		1	pce	328,31

GF JRG Sanipex MT multi-purpose cutter

- Material: steel, plastic



Item No.	Item no. GF	Dimensions	b mm	d mm	l mm	Pallet/ Pack	Box/M QTY	UOM	Price per m/each
1158792	355632420	d12-26	196	12-26	73		1	pce	213,91

GF JRG Sanipex MT pipe cutter

- Material: aluminium, steel

- Consisting of: cutting wheel (351650851)



Item No.	Item no. GF	Dimensions	L mm	W mm	H mm	W kg	Pallet/ Pack	Box/M QTY	UOM	Price per m/each
1158496	351650852	d50-63	250	110	50	0,95		1	pce	254,07

Sanipex MT

GF JRG Sanipex MT marking pen

- Material: wood
- Colour: yellow
- For iFIT, INSTAFLEX, JRG Sanipex, JRG Sanipex MT



Item No.	Item no. GF	L mm	W mm	H mm	W kg	Pallet/Pack	Box/M QTY	UOM	Price per m/each
1157971	351600027	170	10	10	0,008		5	pce	POA

GF JRG Sanipex MT hydraulic oil

- Description: Spare bottle 0.5l to 4810/4812



Item No.	Item no. GF	Dimensions	b mm	h mm	l mm	Pallet/Pack	Box/M QTY	UOM	Price per m/each
1157976	351600072	1l	110	60	230		1	pce	POA

GF JRG Sanipex MT bending toolkit

- Material: plastic, chromed
- Consisting of: 4853.000 hydraulic cylinder, 4854.000 baseplate, 4855.026/.032/.040 bending templates, bending rolls d26-40, 4838.000 marking pen yellow, plug-in bending scale, adapter nipple for bending templates



Item No.	Item no. GF	Dimensions	b mm	d mm	h mm	l mm	Suitable for	Pallet/Pack	Box/M QTY	UOM	Price per m/each
1157966	351600004	d26-40	250	26 - 40	562	665	d26 - 40		1	pce	8 920,07

GF JRG Sanipex MT bending toolkit

- Material: plastic, chromed
- Consisting of: 4854.050 bending templates d50, 4854.063 bending templates d63, bending rolls d50+63



Item No.	Item no. GF	Dimensions	b mm	d mm	h mm	l mm	Suitable for	Pallet/Pack	Box/M QTY	UOM	Price per m/each
1158566	352920372	d50-63	250	50 + 63	562	665	d50 + d63		1	pce	3 487,63

GF JRG Sanipex MT hydraulic bending template

- Material: aluminium
- Suitable to: 4810 hydraulic unit, 4852 / 4853 bending tools



Item No.	Item no. GF	Dimensions	b mm	d mm	r mm	Pallet/Pack	Box/M QTY	UOM	Price per m/each
1158296	351626911	d26	146	26	78		1	pce	POA
1158376	351632911	d32	180	32	96		1	pce	POA
1158437	351640911	d40	225	40	120		1	pce	POA

Aqua Pipe



For use with Uponor Q&E, Uponor Aqua Pipe is manufactured from highest quality cross-linked PE-Xa polyethylene, and is designed for tap water applications and distribution pipes.

Benefits

- Uponor Q&E
- Hygienic
- Certified quality
- Corrosion resistant
- Thermal memory
- Lightweight and very flexible
- Durable

Application

- Hot water services - where the water temperature does not continuously exceed 70°C, maximum design pressure of 6 bar (conditions to class 2 - BS EN ISO 15875-1:2003). The maximum short-term malfunction temperature is 95°C for an accumulative 100 hours over the working life of the system.

- Cold water services <20 °C - where the maximum system pressure does not exceed the maximum operating pressure of 10 bar.

- Uponor Q&E Shrink-fit system can be used for DHW recirculating systems, provided the operating temperatures and pressures do not exceed the maximum conditions detailed under 'Hot water services'

Specification

- Pipes manufactured from cross-linked polyethylene - PE-Xa acc. BS EN ISO 15875
- Application class 1 & 2 - Hot water supply
- Fire class E according to BS EN 13501-1.
- Conduits manufactured from high density polyethylene

Certification

UK Reg4 approval
 - WRAS or
 - KIWA
 to meet the requirements of the Water Supply (Water Fittings) Regulations 1999

Uponor Aqua Pipe natural Aenor PN6, S

- Operating pressure 6 bar
- Bar



Item No.	Dimensions	do mm	s mm	p mm	Pallet/ Pack	Box/M QTY	UOM	Price per m/each
1033485	50x4,6 5m	50	4,6	6	550	10	m	30,90
1033506	63x5,8 5m	63	5,8	6	350	5	m	49,70

Compatible with:

Radi Pipe



Benefits

- Uponor Q&E
- Certified quality
- Corrosion resistant
- Thermal memory
- Lightweight and very flexible
- Durable
- Oxygen diffusion tight

For use with Uponor Q&E, Uponor Radi Pipe is manufactured from highest quality cross-linked PE-Xa polyethylene, and is designed for use with heating and cooling applications as well as distribution pipes.

Application

- Heating: The permanent operating temperature ranges up to 80°C. The short-term malfunction temperature is 100°C for a period of 100 hours in the operating life time.

Specification

- Pipes manufactured from cross-linked polyethylene - PE-Xa acc. BS EN ISO 15875 with EVOH oxygen barrier
- Application class 5 - high temperature radiators
- Fire class E according to BS EN 13501-1.
- Conduits manufactured from high density polyethylene

Uponor Radi Pipe natural PN6

- Operating pressure 6 bar
- Coil

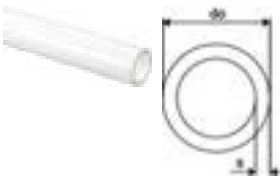

Item No.	Dimensions	do mm	s mm	p bar	Pallet/ Pack	Box/M QTY	UOM	Price per m/each
1001220	32x2,9 50m	32	2,9	6	550	50	m	14,45
1008449	32x2,9 100m	32	2,9	6	700	100	m	14,32
1008979	40x3,7 50m	40	3,7	6	350	50	m	18,95
1008975	40x3,7 100m	40	3,7	6	700	100	m	17,95
1008980	50x4,6 50m	50	4,6	6	350	50	m	28,96
1008981	63x5,8 50m	63	5,8	6		50	m	44,96
1008982	75x6,8 50m	75	6,9	6	50	50	m	62,35

Uponor Radi Pipe natural PN6 S

- Operating pressure 6 bar
- 6m bars



Item No.	Dimensions	do mm	do1 mm	s mm	p bar	Pallet/ Pack	Box/M QTY	UOM	Price per m/each
1008940	50x4,6 6m	50		4,6	6	660	6	m	34,46
1008941	63x5,8 6m	63		5,8	6	420	6	m	53,25

Uponor Radi Pipe white PN6

- Operating pressure 6 bar
- Coils
- White

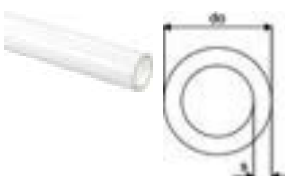

Item No.	Dimensions	do mm	s mm	p bar	Pallet/ Pack	Box/M QTY	UOM	Price per m/each
1085245	12x1,1 100m	12	1,1	6	1500	100	m	2,56

Combi Pipe



Benefits

- Uponor Q&E
- Hygienic for tap-water installations
- With oxygen barrier for heating installations
- Corrosion resistant
- Thermal memory
- Lightweight and very flexible
- Durable
- Oxygen diffusion tight

For use with Uponor Q&E, Uponor Combi Pipe is manufactured from highest quality cross-linked PE-Xa polyethylene, and is designed for tap water applications and distribution pipelines.

Application

- Tap water: The permanent operating temperature ranges from 0°C to 70°C at a maximum permanent operating pressure of 6 bar. The short-term malfunction temperature is 95°C for a period of 100 hours in the operating life time.
- Underfloor heating and low temperature radiators
- Heating: The permanent operating temperature ranges up to 80°C at a maximum permanent operating pressure of 6 bar. The short-term malfunction temperature is 100°C for a period of 100 hours in the operating life time.

Specification

- Pipes manufactured from cross-linked polyethylene - PE-Xa acc. BS EN ISO 15875
- Fire class E according to BS EN 13501-1.
- Conduits manufactured from high density polyethylene
- EVOH (ethylene vinyl alcohol) layer for oxygen diffusion resistance as per DIN 4726

Certification

- UK Reg4 approval
 - WRAS or
 - KIWA
- To meet the requirements of the Water Supply (Water Fittings) Regulations 1999

Uponor COMBI PIPE PIPE WHITE PN6

- Operating pressure 6 bar
- Coils
- White



Item No.	Dimensions	do	s	Pallet/ Pack	Box/M QTY	UOM	Price per m/each
1084387	32x2,9 50M	32	2,9	300	50	m	10,05

Combi Pipe

Uponor COMBI PIPE PIPE WHITE PN6 S

- Operating pressure 6 bar
- 5m bars
- White



Item No.	Dimensions	do mm	s mm	p bar	Pallet/ Pack	Box/M QTY	UOM	Price per m/each
1083815	32x2,9 5M	32	2,9	6	1785	35	m	15,00

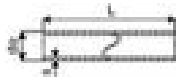

Uponor Combi Pipe white opaque PN6

- Operating pressure 6 bar
- Coils
- White with opaque layer

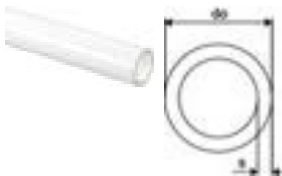

Item No.	Dimensions	do mm	s mm	p bar	Pallet/ Pack	Box/M QTY	UOM	Price per m/each
1059173	16x1,8 50m	16	1,8	6	550	50	m	3,67
1059182	16x1,8 100m	16	1,8	6	1100	100	m	3,67
1059174	20x1,9 50m	20	1,9	6	550	50	m	6,88
1059175	25x2,3 50m	25	2,3	6	450	50	m	9,27

Uponor Combi Pipe white opaque PN6 S

- Operating pressure 6 bar
- bars
- white with opaque layer



Item No.	Dimensions	do mm	s mm	p bar	Pallet/ Pack	Box/M QTY	UOM	Price per m/each
1058803	16x1,8 3m	16	1,8	6	2625	75	m	3,91
1058804	20x1,9 3m	20	1,9	6	1680	48	m	7,43
1058805	25x2,3 3m	25	2,3	6	1050	30	m	9,80



Uponor Combi Pipe opaque in conduit red

- Fire class E according to BS EN 13501-1
- Conduits manufactured from high density polyethylene



Item No.	Dimensions	di1 mm	do mm	do1 mm	s mm	p bar	Pallet/ Pack	Box/M QTY	UOM	Price per m/each
1059179	16x1,8 25/20 50m	20	16	25	1,8	6	550	50	m	6,06

Compatible with:



Benefits

- For use with PE-Xa - Aqua, Radi or Combi pipes
- Flexible pipe system ideal for in-wall installations
- Corrosion resistant
- Full bore connections, low pressure loss
- Fast, reliable connections
- Flame-free installation
- Q&E rings colour coded to identify each service

Uponor Q&E is a unique and innovative fitting system that uses the shrink-back effect of cross-linked polyethylene PE-Xa pipes for quick and easy installation.

A wide range of fittings and accessories makes Q&E a versatile and secure system for cost-effective installations.

Q&E is fast to install and is completely flame-free. Due to the fast connection process, a system can be pressure tested in under an hour.

Specification

- Q&E fittings and rings for Uponor PE-Xa pipes
- Metal fittings are made of high quality brass
- Plastic fittings are made of PPSU
- Q&E rings must be ordered separately
- Threads acc. To BS EN 10226-1

Application

- For connection of
- drinking water systems
 - heating systems
 - radiant heating and cooling systems

Certification

- UK Reg4 approval
- WRAS or
 - KIWA
- To meet the requirements of the Water Supply (Water Fittings) Regulations 1999

Uponor Q&E evolution ring white

- Conical inner shape
- With stop edge
- PE material

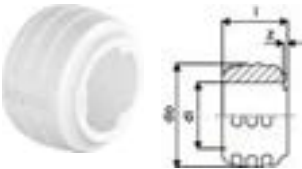

Item No.	Dimensions	di mm	l mm	do mm	z mm	p bar	Pallet/Pack	Box/M QTY	UOM	Price per m/each
1057453	16	16,2	16	25,3	1	6+10	900	20	pce	0,58
1057454	20	20,2	20	29,2	1	6+10	520	20	pce	0,69
1057455	25	25,3	25	34,6	1	6+10	300	20	pce	0,81
1057456	32	32,4	32	41,8	1,3	6+10	150	10	pce	1,70

Uponor Q&E evolution ring red

- Conical inner shape
- With stop edge
- PE material

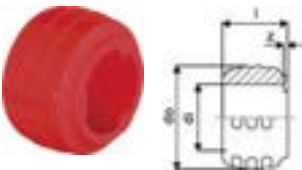

Item No.	Dimensions	di mm	l mm	do mm	z mm	p bar	Pallet/Pack	Box/M QTY	UOM	Price per m/each
1058010	16	16,2	16	25,3	1	6+10	900	20	pce	0,58
1058011	20	20,2	20	29,2	1	6+10	520	20	pce	0,69
1058012	25	25,3	25	34,6	1	6+10	300	20	pce	0,81

Uponor Q&E evolution ring blue

- Conical inner shape
- With stop edge
- PE material

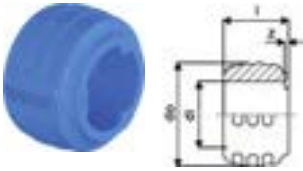

Item No.	Dimensions	di mm	l mm	do mm	z mm	p bar	Pallet/ Pack	Box/M QTY	UOM	Price per m/each
1058013	16	16,2	16	25,3	1	6+10	900	20	pce	0,58
1058014	20	20,2	20	29,2	1	6+10	520	20	pce	0,69
1058015	25	25,3	25	34,6	1	6+10	300	20	pce	0,81

Uponor Q&E ring with stop edge natural

- With stop edge
- PEX material

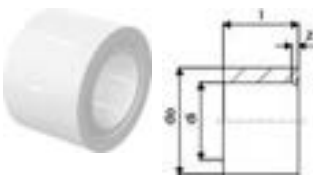

Item No.	Dimensions	di mm	l mm	do mm	z mm	p bar	Pallet/ Pack	Box/M QTY	UOM	Price per m/each
1045464	40	40,8	40,5	50,2	2,5	6+10	80	5	pce	2,26
1045489	50	51	50	63	3,5	6+10	70	5	pce	5,45
1045490	63	64,3	63	75,7	4,2	6+10	35	5	pce	9,34

Uponor Q&E ring with stop edge red

- With stop edge
- PEX material

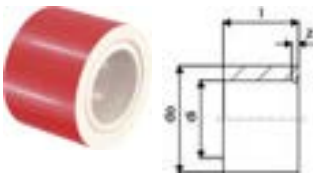

Item No.	Dimensions	di mm	l mm	do mm	z mm	p bar	Pallet/ Pack	Box/M QTY	UOM	Price per m/each
1058454	12	12,3	13	18,3	1,4	6+10	1200	20	pce	0,31

Uponor Q&E ring with stop edge blue

- With stop edge
- PEX material



Item No.	Dimensions	di mm	l mm	do mm	z mm	p bar	Pallet/ Pack	Box/M QTY	UOM	Price per m/each
1058453	12	12,3	13	18,3	1	6+10	1200	20	pce	0,32

Uponor Q&E manifold double PPSU

- Main supply connection for Q&E 20 or 25mm
- Outlet connections in Q&E
- Made of PPSU

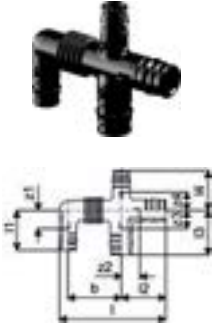

Item No.	Dimensions	l1 mm	l2 mm	l3 mm	l mm	b mm	z1 mm	z2 mm	z3 mm	z4 mm	p bar	Pallet/ Pack	Box/M QTY	UOM	Price per m/
1008722	20 1x20+2x16 c/c45mm	33,5	37,5	37,5	89,7	45	15,5	15,5	15,5	15,5	6+10	15	1	pce	8,84
1008723	20 1x20+3x16 c/c45mm	33,5	37,5	33,5	89,7	45	15,5	15,5	15,5	15,5	6+10	15	1	pce	8,92
1008724	25 1x20+2x16 c/c45	33,5	45	37,5	97,2	45	15,5	17,5	15,5	15,5	6+10	15	1	pce	10,15
1008725	25 1x20+3x16 c/c45	33,5	45	33,5	97,1	45	15,5	15,5	15,5	15,5	6+10	15	1	pce	11,14

Uponor Q&E manifold male thread PPSU

- Main supply connection in 3/4" thread
- Outlet connections in Q&E
- Made of PPSU



Item No.	Dimensions	G inch	l1 mm	l2 mm	l3 mm	l mm	b mm	z1 mm	z2 mm	z3 mm	p bar	Pallet/ Pack	Box/M QTY	UOM	Price per m/
1008714	G3/4"MT 3x16 c/c45+35mm	3/4	34	45	34	133	45	16	27	16	6+10	10	1	pce	18,60
1008715	G3/4"MT 4x16 c/c45+2x35mm	3/4	34	45	34	168	45	16	27	16	6+10	10	1	pce	19,42

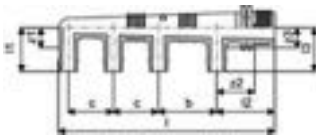

Uponor Q&E adapter male thread PPSU

- Made of PPSU



Item No.	Dimensions	G inch	l1 mm	l2 mm	l mm	z1 mm	p bar	Pallet/ Pack	Box/M QTY	UOM	Price per m/each
1008661	16-G1/2"MT	1/2	16	18	42	8	6+10	90	5	pce	6,24
1008662	20-G1/2"MT	1/2	16	22	46	8	6+10	80	5	pce	7,35
1008663	20-G3/4"MT	3/4	18	22	48	8	6+10	60	5	pce	7,35
1008664	25-G3/4"MT	3/4	18	28	54	8	6+10	50	5	pce	7,84
1008665	25-G1"MT	1	23	28	58	8	6+10	40	5	pce	11,98

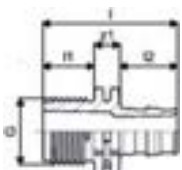

Uponor Q&E adapter female thread PPSU

- Made of PPSU

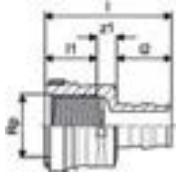

Item No.	Dimensions	Rp inch	l1 mm	l2 mm	l mm	z1 mm	p bar	Pallet/ Pack	Box/M QTY	UOM	Price per m/each
1042329	16-Rp1/2"FT	1/2	17	18	41,5	6,5	6+10	80	5	pce	8,41
1042331	20-Rp3/4"FT	0,75	17,5	22	47	7,5	6+10	50	5	pce	10,91
1042332	25-Rp3/4"FT	0,75	18	28	52	6	6+10	40	5	pce	12,65

Uponor Q&E Elbow PPS

- Made from PPS



Item No.	In/Out	Dimensions	l1 mm	l2 mm	z1 mm	z2 mm	Pallet/ Pack	Box/M QTY	UOM	Price per m/each
1144509	05.26	16-16	27	31,5	9	13,5	100	5	pce	1,93
1144510	05.26	20-20	34	38,5	12	16,5	40	5	pce	2,90
1144511	05.26	25-25	42	47	14,5	19,5	25	5	pce	3,89

Uponor Q&E elbow PPSU

- Made of PPSU



Item No.	Dimensions	l1 mm	l2 mm	z1 mm	z2 mm	p bar	Pallet/ Pack	Box/M QTY	UOM	Price per m/each
1001245	32-32	53	59	18	23	6+10	10	1	pce	12,09
1008683	40-40	65	73,5	21	29	6+10	10	1	pce	23,68
1042859	50-50	83	98	29	44	6+10	5	1	pce	44,51
1042858	63-63	100	111,5	33	44	6+10	3	1	pce	79,67

Uponor Q&E elbow adapter male thread PPSU

- Material: PPSU

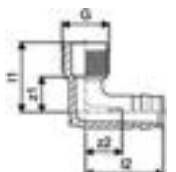

Item No.	Dimensions	G inch	l1 mm	l2 mm	z1 mm	z2 mm	p bar	Pallet/ Pack	Box/M QTY	UOM	Price per m/each
1008666	16-G1/2"MT	1/2	30,6	34	15,3	16	6+10	80	5	pce	5,84
1008667	20-G1/2"MT	1/2	30,6	38	15,3	16	6+10	60	5	pce	6,78
1008668	25-G3/4"MT	3/4	36	42	18,3	14,5	6+10	40	5	pce	8,99

Uponor Q&E elbow adapter female thread PPSU

- Only use with flat PTFE thread sealing tape, must not use cord type thread sealing



Item No.	Dimensions	Rp inch	l1 mm	l2 mm	z1 mm	z2 mm	p bar	Pallet/Pack	Box/M QTY	UOM	Price per m/each
1042334	16-Rp1/2"FT	0,5	26,5	33	9,7	15	6+10	50	5	pce	7,78
1042335	20-Rp1/2"FT	0,5	26,5	38	9,3	16	6+10	50	5	pce	12,93
1042336	20-Rp3/4"FT	0,75	29,5	41	12	19	6+10	40	5	pce	12,93
1042337	25-Rp3/4"FT	0,75	31,5	46,5	14	19	6+10	35	5	pce	12,93

Uponor Q&E coupling PPSU

- Material: PPSU

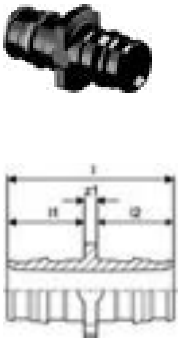

Item No.	Dimensions	l1 mm	l2 mm	l mm	z1 mm	p bar	Pallet/Pack	Box/M QTY	UOM	Price per m/each
1008669	16-16	18	18	39	3	6+10	100	5	pce	2,41
1008932	20-20	22	22	47	3	6+10	80	5	pce	3,38
1008671	25-25	27,5	27,5	58	3	6+10	50	5	pce	5,16
1001235	32-32	35	35	73	3	6+10	15	1	pce	9,44
1008673	40-40	43,5	43,5	90	3	6+10	10	1	pce	18,12
1042866	50-50	54	54	113	5	6+10	10	1	pce	31,95
1042865	63-63	67,5	67,5	141	6	6+10	5	1	pce	50,88

Uponor Q&E reducer PPSU

- Material: PPSU

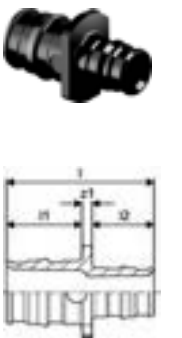

Item No.	Dimensions	l1 mm	l2 mm	l mm	z1 mm	p bar	Pallet/Pack	Box/M QTY	UOM	Price per m/each
1008674	20-16	22	18	43	3	6+10	100	5	pce	3,29
1008675	25-16	28	18	49	3	6+10	40	5	pce	5,23
1008676	25-20	22	28	53	3	6+10	40	5	pce	6,54
1001240	32-25	28	35	66	3	6+10	20	1	pce	8,14
1008678	40-32	35	44	82	3	6+10	10	1	pce	13,35
1042879	50-32	54	35	94	5	6+10	10	1	pce	36,30
1042867	50-40	54	44	103	5	6+10	10	1	pce	34,56
1042877	63-50	68	54	128	6	6+10	5	1	pce	51,91

Uponor Q&E Tee PPS

- Made from PPS



Item No.	In/Out	Dimensions	l1 mm	l2 mm	l3 mm	z1 mm	z2 mm	z3 mm	Pallet/Pack	Box/M QTY	UOM	Price per m/each
1144513	05.26	20-20-20	38,5	34,3	38,5	16,5	12,3	16,5	30	5	pce	4,05

Uponor Q&E tee PPSU

- Material: PPSU
- Large packaging quantity

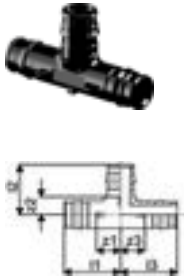

Item No.	Dimensions	l1 mm	l2 mm	l3 mm	z1 mm	z2 mm	z3 mm	p bar	Pallet/Pack	Box/M QTY	UOM	Price per m/each
1008684	16-16-16	31,5	27	31,5	14	9,5	14	6+10	60	5	pce	3,51
1008686	25-25-25	47	42	47	19,5	14,5	19,5	6+10	20	5	pce	8,45
1001250	32-32-32	59	52,8	59	24	17,8	24	6+10	10	1	pce	18,82
1008688	40-40-40	73,5	65	73,5	30	21,5	30	6+10	5	1	pce	30,44
1042861	50-50-50	92	83	92	38	29	38	6+10	3	1	pce	72,69
1042860	63-63-63	111,5	102	111,5	44	4,5	44	6+10	2	1	pce	119,51

Uponor Q&E tee reducer PPSU

- Material: PPSU
- Large packaging quantity

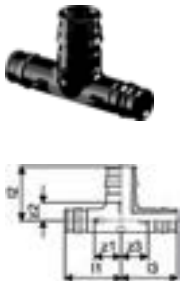

Item No.	Dimensions	l1 mm	l2 mm	l3 mm	z1 mm	z2 mm	z3 mm	p bar	Pallet/Pack	Box/M QTY	UOM	Price per m/each
1008710	16-20-16	34,5	33	34,5	16,5	11	16,5	6+10	40	5	pce	5,68
1008700	20-16-16	35,5	29,25	31,5	13,5	11,25	13,5	6+10	40	5	pce	5,68
1008689	20-16-20	35,5	29,25	35,5	13,5	11,25	13,5	6+10	40	5	pce	5,68
1008697	20-20-16	35,5	34	31,5	13,5	12	13,5	6+10	40	5	pce	5,68
1008711	20-25-20	41,5	39,75	41,5	19,5	12,25	19,5	6+10	25	5	pce	8,53
1008702	25-16-16	41	31,5	31,5	13,5	13,5	13,5	6+10	25	5	pce	8,53
1008699	25-16-20	41	31,5	35,5	13,5	13,5	13,5	6+10	25	5	pce	8,53
1008690	25-16-25	41	31,5	41	13,5	13,5	13,5	6+10	25	5	pce	8,53
1008701	25-20-16	44	36,5	34,5	16,5	14,5	16,5	6+10	25	5	pce	8,53
1008703	25-20-20	44	36,5	38,5	16,5	14,5	16,5	6+10	25	5	pce	8,53
1008691	25-20-25	44	36,5	44	16,5	14,5	16,5	6+10	20	5	pce	7,84
1001420	25-25-20	47	42	41,5	19,5	14,5	19,5	6+10	20	5	pce	9,80
1008712	25-32-25	51,5	49,5	51,5	24	14,5	24	6+10	15	1	pce	14,75
1001422	32-20-25	51,5	39,8	44	16,5	17,8	16,5	6+10	15	1	pce	13,70
1001424	32-20-32	51,5	39,8	51,5	16,5	17,8	16,5	6+10	15	1	pce	14,68
1008704	32-25-20	54,5	45	41,5	19,5	17,5	19,5	6+10	15	1	pce	14,27
1001426	32-25-25	54,5	45	47	19,5	17,5	19,5	6+10	15	1	pce	14,94
1001428	32-25-32	54,5	45	54,5	19,5	17,5	19,5	6+10	15	1	pce	16,17
1008713	32-40-32	65	61	65	30	17,5	30	6+10	10	1	pce	24,45
1008707	40-20-32	60	43,5	51,5	16,5	21,5	16,5	6+10	5	1	pce	23,31
1008694	40-20-40	60	43,5	60	16,5	21,5	16,5	6+10	5	1	pce	23,46
1008708	40-25-32	63	49	54,5	19,5	21,5	19,5	6+10	5	1	pce	23,72
1008695	40-25-40	63	49	63	19,5	21,5	19,5	6+10	5	1	pce	25,20
1008709	40-32-32	67,5	56,5	59	24	21,5	24	6+10	5	1	pce	25,01
1008696	40-32-40	67,5	56,5	67,5	24	21,5	24	6+10	5	1	pce	27,03
1042876	50-25-40	92	56,5	82	38,25	29	38,5	6+10	4	1	pce	55,44
1042864	50-25-50	91,5	56,5	91,5	37,5	29	37,5	6+10	4	1	pce	59,85
1042863	50-32-50	91,5	64	91,5	37,5	29	37,5	6+10	4	1	pce	61,07
1042871	63-25-50	111,5	62	98,5	44	34,5	44,5	6+10	2	1	pce	92,87
1042873	63-25-63	111,5	60	111,5	44	32,5	44	6+10	2	1	pce	103,03
1042870	63-32-63	111,5	69,5	111,5	44	34,5	44	6+10	2	1	pce	97,80

Uponor Q&E tee adapter female thread PPSU

- Only use with flat PTFE thread sealing tape, must not use cord type thread sealing

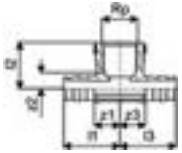

Item No.	Dimensions	Rp inch	l1 mm	l2 mm	l3 mm	z1 mm	z2 mm	z3 mm	p bar	Pallet/ Pack	Box/M QTY	UOM	Price per m/each
1042338	16-Rp1/2"FT-16	0,5	33	28	33	15	10	15	6+10	50	5	pce	8,08
1042339	20-Rp1/2"FT-20	0,5	38	27	38	16	10	16	6+10	40	5	pce	10,14
1042341	25-Rp3/4"FT-25	0,75	47	31	47	19	12,5	19	6+10	25	5	pce	13,29

Uponor Q&E adapter swivel nut PPSU

- Supplied flat sealing washer

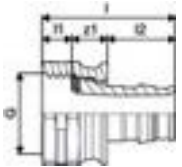

Item No.	Dimensions	G inch	l1 mm	l2 mm	l mm	z1 mm	p bar	Pallet/ Pack	Box/M QTY	UOM	Price per m/each
1038021	16-G1/2"SN	0,5	8	18	35	9	6+10	50	1	pce	10,35
1038022	20-G1/2"SN	0,5	9	22	47	16	6+10	40	1	pce	9,43
1038023	20-G3/4"SN	0,75	8	22	39	9	6+10	30	1	pce	10,93
1038024	25-G3/4"SN	0,75	8	28	53	17	6+10	25	1	pce	13,14

Uponor Q&E elbow adapter swivel nut PPSU

- Supplied flat sealing washer

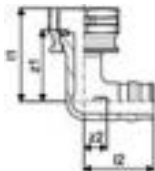

Item No.	Dimensions	G inch	l1 mm	l2 mm	z1 mm	z2 mm	p bar	Pallet/ Pack	Box/M QTY	UOM	Price per m/each
1038037	16-G1/2"SN	0,5	36	27	28	9	6+10	40	1	pce	10,92
1038038	20-G1/2"SN	0,5	38	31	30	10	6+10	35	1	pce	10,93

Uponor Q&E manifold male female thread PL

- Made of Brass

- Q&E connections are applied directly onto the manifold outlets

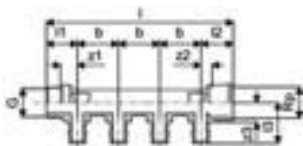

Item No.	Dimensions	G inch	G1 inch	Rp inch	l1 mm	l2 mm	l3 mm	l mm	b mm	z1 mm	z2 mm	p bar	Pallet/ Pack	Box/M QTY	UOM	Price per m/
1023029	3/4"MT/FT 4x16 c/c35mm	0,75	0,75	26,5	27,5	34,5	159	35	14,5	9,4	6+10	10	1	1	pce	50,10

Uponor Q&E adapter male thread PL W

- Made of Brass

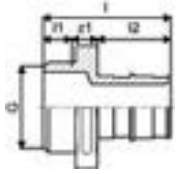

Item No.	In/Out	Dimensions	G inch	l1 mm	l2 mm	l mm	z1 mm	Pallet/ Pack	Box/M QTY	UOM	Price per m/each
1145656	01.25	32-G1"MT	1	10	34	56	12	32	8	pce	21,40
1145657	01.25	40xG1 1/4"MT	1 1/4	14	42	68	12	32	8	pce	35,14
1145659	01.25	63-G2"MT	2	17	65	95	13	8	2	pce	125,50

Uponor Q&E adapter female thread PL

- Made of Brass

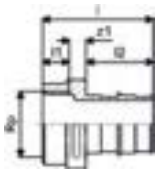

Item No.	Dimensions	G inch	Rp inch	l1 mm	l2 mm	l mm	z1 mm	p bar	Pallet/ Pack	Box/M QTY	UOM	Price per m/each
1047867	40-G1 1/4"FT	1 1/4	1,25	16	42	68	10	6+10	20	1	pce	63,25

Uponor Q&E adapter female thread PL

- Brass Fitting

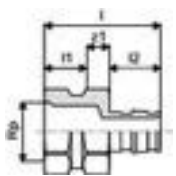

Item No.	In/Out	Dimensions	G inch	Rp inch	l1 mm	l2 mm	l mm	z1 mm	p bar	Pallet/ Pack	Box/M QTY	UOM	Price per m/each
1145668	01.25	25-RP3/4"FT	3/4	18	27	50	5	6+10	40	10	pce	13,05	
1145670	01.25	25-RP1"FT	1	22	27	55	6		40	10	pce	22,76	
1145690	01.25	32-G1"FT	1	13	34	56	9		20	5	pce	26,10	

Uponor Q&E elbow PL

- Made of Brass



Item No.	Dimensions	l1 mm	l2 mm	z1 mm	z2 mm	p bar	Pallet/ Pack	Box/M QTY	UOM	Price per m/each
1058470	12-12	29	29	14	14	6+10	200	10	pce	6,14

Uponor Q&E elbow adapter male thread PL

- Made from Brass

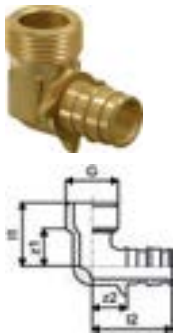

Item No.	In/Out	Dimensions	G inch	l1 mm	l2 mm	z1 mm	z2 mm	Pallet/ Pack	Box/M QTY	UOM	Price per m/each
1145672	01.25	20-G3/4"MT	3/4	29	35,5	18	13,6	40	10	pce	11,57

Uponor Q&E elbow adapter female thread PL

- Made from Brass



Item No.	In/Out	Dimensions	G inch	l1 mm	l2 mm	z1 mm	z2 mm	p bar	Pallet/ Pack	Box/M QTY	UOM	Price per m/each
1145644	01.25	16-G1/2"FT	1/2	25	32	10,5	14		80	20	pce	7,64
1145645	01.25	20-G1/2"FT	1/2	25	36	10,5	14		60	15	pce	10,91
1145652	01.25	25-G3/4"FT	3/4	26	43,5	9,5	16,5	6+10	40	10	pce	13,58
1145674	01.25	20-G3/4"FT	3/4	26	38,5	9,5	16,5		40	10	pce	12,73

Uponor Q&E adapter male thread PL

- Made from Brass



Item No.	In/Out	Dimensions	G inch	l1 mm	l2 mm	l mm	R inch	z1 mm	p bar	Pallet/ Pack	Box/M QTY	UOM	Price per m/each
1145647	01.25	25-G3/4"MT	3/4	11	27	46,5		9		60	15	pce	9,20
1145650	01.25	20-G3/4"MT	3/4	11	22	41,5		9		80	20	pce	5,91
1145655	01.25	25-G1"MT	1	11	27	49		11		40	10	pce	16,44
1145689	01.25	50-G1 1/2"MT	1 1/2	17	52	82		13		16	4	pce	59,69

Uponor Q&E adapter swivel nut PL

- Made of Brass

- Supplied with flat sealing washer

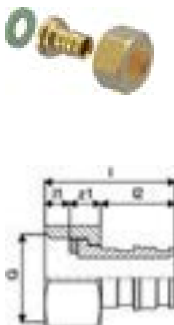

Item No.	Dimensions	G inch	l1 mm	l2 mm	l mm	z1 mm	p bar	Pallet/ Pack	Box/M QTY	UOM	Price per m/each
1058466	12-G1/2"SN	1/2	6	15	28,5	7,5	6+10	100	10	pce	2,77
1023014	16-G1/2"SN	0,5	6	18	31,5	7,5	6+10	100	5	pce	5,81
1023015	20-G1/2"SN	0,5	7,5	22	42	12,5	6+10	60	5	pce	7,48
1023016	20-G3/4"SN	0,75	6,5	22	36	7,5	6+10	50	5	pce	7,60
1023017	25-G3/4"SN	0,75	6,5	27	48,5	15	6+10	45	5	pce	12,51
1023018	25-G1"SN	1	10	27	44	7	6+10	40	5	pce	13,79

Uponor Q&E adapter DR S-Press

- Adapter to connect Q&E to Multilayer (MLCP)
- Requires press tool to make the Multilayer connection
- Brass Fitting



Item No.	In/Out	Dimensions	l1 mm	l2 mm	l mm	z1 mm	Pallet/ Pack	Box/M QTY	UOM	Price per m/each
1145698	01.25	16-Q&E16	22	18	47	8	80	20	pce	13,25
1145699	01.25	20-Q&E20	23	22	52	8	60	15	pce	12,80
1145700	01.25	25-Q&E25	31	27	65	8	40	10	pce	17,65

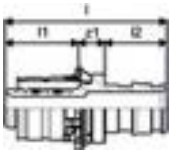

Uponor Q&E adapter for soldering PL

- Adapter to solder onto copper pipe acc. to EN 1057

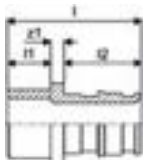

Item No.	Dimensions	l1 mm	l2 mm	l mm	z1 mm	p bar	Pallet/ Pack	Box/M QTY	UOM	Price per m/each
1085248	12-15CU	13	15	32	4	6+10	100	5	pce	3,65
1023041	20-15CU	13	22	38	3	6+10	100	5	pce	7,02
1047943	32-28CU	16	34	56	6	6+10	20	1	pce	54,95

Uponor Q&E adapter for soldering PL

- Adapter to solder onto copper pipe acc. to EN 1057

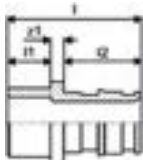

Item No.	In/Out	Dimensions	l1 mm	l2 mm	l mm	z1 mm	Pallet/ Pack	Box/M QTY	UOM	Price per m/each
1145649	01.25	16-15CU	13	18	34	3	100	25	pce	3,80
1145675	01.25	25-22CU	13	27	43	3	40	10	pce	7,56

Uponor Q&E adapter PL

- Adapter to connect into a standard compression fitting acc. to BS 1254-2 in place of a copper tube
- Demountable and resealable

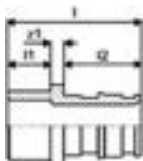

Item No.	In/Out	Dimensions	l1 mm	l2 mm	l mm	z1 mm	Pallet/ Pack	Box/M QTY	UOM	Price per m/each
1145696	01.25	20xCu22	13	22	38	3	100	25	pce	8,55
1145697	01.25	25xCu28	16	27	49	6	40	10	pce	10,07

Uponor Q&E adapter DR

- Adapter to connect into a standard compression fitting acc. to BS 1254-2 in place of a copper tube
- Demountable and resealable

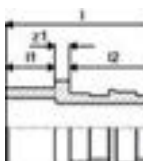

Item No.	In/Out	Dimensions	l1 mm	l2 mm	l mm	z1 mm	Pallet/ Pack	Box/M QTY	UOM	Price per m/each
1145658	01.25	16-15CU L=16MM	15	18	36	3	100	25	pce	8,14

Uponor Q&E valve, with handle

- Made of brass

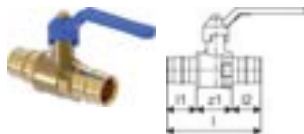

Item No.	Dimensions	l1 mm	l2 mm	l mm	z1 mm	Pallet/ Pack	Box/M QTY	UOM	Price per m/each
1038428	25-25	27	27	85,5	31,5	10	1	pce	29,70
1038429	32-32	19	25,5	112,5	48,5	5	1	pce	54,11

Uponor Q&E reducer, rings Minitec

- Q&E
- Made of Brass
- With Q&E rings

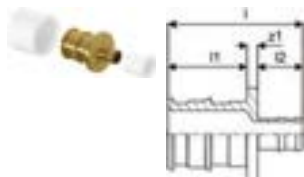

Item No.	Dimensions	l1 mm	l2 mm	l mm	z1 mm	Pallet/ Pack	Box/M QTY	UOM	Price per m/each
1020518	20xMinitec9,9	22	12,6	37,6	3	150	5	pce	8,08

Uponor Q&E tee reduced, rings Minitec







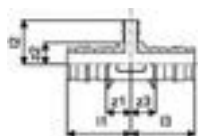















- Q&E
- Made of Brass
- With Q&E rings



Item No.	Dimensions	l1 mm	l2 mm	l3 mm	z1 mm	z2 mm	z3 mm	Pallet/ Pack	Box/M QTY	UOM	Price per m/each
1020524	20xMinitec9,9xQ&E20	36	24,6	36	14	12	14	75	5	pce	11,37



Compatible with:

Item No.	Dimension	Pallet/ Pack	Box/M QTY	UOM	Price per m/each
 1045451	Uponor Uni-C bracket SH 3/4" 1"	25	1	set	31,85
 1008497	Uponor Fluvia end cap w. bleeder G3/4		200	pce	10,69
 1059820	Uponor Smart Aqua U-tap elbow Q&E 16-Rp1/2"FT-16	5	1	pce	48,95
 1059821	Uponor Smart Aqua U-tap elbow Q&E 20-Rp1/2"FT-20	5	1	pce	63,32
 1059822	Uponor Smart Aqua tap elbow Q&E PL 16-Rp1/2"FT	40	5	pce	14,38
 1059823	Uponor Smart Aqua tap elbow Q&E PL 20-Rp1/2"FT	40	5	pce	16,35
 1121196	Uponor S-PRESS PLUS mounting angle 100mm	5	1	pce	6,65
 1121195	Uponor S-Press PLUS mounting angle 80/150mm	5	1	pce	6,82
 1121197	Uponor S-Press PLUS mounting plate 80/150mm	1120	5	pce	3,79
 1057844	Uponor Smart Aqua mounting rack 2m	10	1	pce	23,78
 1042342	Uponor Smart Aqua tap elbow Q&E PPSU 16-Rp1/2" l=43mm	40	5	pce	9,04
 1023045	Uponor Smart Radi elbow adapter plated Q&E 16-15CU l=300mm	40	2	pce	25,12
 1047999	Uponor Aqua PLUS manifold Q&E PPM 1" 2x16 c/c50mm	10	1	pce	20,26
 1048000	Uponor Aqua PLUS manifold Q&E PPM 1" 3x16 c/c50mm	8	1	pce	22,79
 1048001	Uponor Aqua PLUS manifold Q&E PPM 1" 4x16 c/c50mm	6	1	pce	30,41
 1047997	Uponor Aqua PLUS manifold PPM 1" 1xG1/2"MT c/c50mm	20	1	pce	17,73
 1047998	Uponor Aqua PLUS manifold PPM 1" 1xG3/4"MT c/c50mm	20	1	pce	19,43
 1048002	Uponor Aqua PLUS adapter male thread PPM 1" G3/4"MT	20	1	pce	13,93
 1048003	Uponor Aqua PLUS elbow adapter male PPM 1" G3/4"MT	20	1	pce	14,19
 1048004	Uponor Aqua PLUS manifold end cap PPM 1"FT	20	1	pce	9,14
 1048005	Uponor Aqua PLUS end cap, air nipple PPM 1"FT	20	1	pce	24,16
 1092021	Uponor Aqua PLUS manifold bracket PPM	50	1	set	14,78
 1001337	Uponor Aqua PLUS manif end cap flat seal 3/4"FT	250	10	pce	6,39

Sanipex Classic



Benefits

- Superior low pressure losses
- Water pocket free hygienic connections
- Detachable and reusable connection without elastomere sealing
- Hardly any noise pollution
- No power supply required

JRG Sanipex is a pipe-in-pipe installation system. The system consists of a water-carrying inner pipe made of cross-linked polyethylene (PE-X) in a protective and insulating conduit, which is installed directly from the basement or floor level distribution to the fitting connections. All water-carrying system parts (distributors, bends, valves, transitions) are made of corrosion resistant gunmetal.

Specification

- The pipe-in-pipe technology enables the pipes to be installed directly into the concrete.
- The water-carrying inner pipe of dimensions d12 and d16 – if it has been installed in the protective conduit – can be replaced without prising open the floor coverings and wall plates if damaged.

Application

- Application area Cold and hot water, HVAC, compressed air, greywater
- Installation
- above all, flush-mounted pipes from distributors to the location of the taps in pipe-in-pipe technology

Certification

- 3,1
- SVGW
- KIWA
- ÖVGW

GF JRG Sanipex fitting connector double FT

- Material: gunmetal
- Connection: female thread, cone grip unions
- *as long as stock last

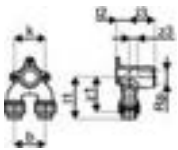

Item No.	Item no. GF	In/Out	Dimensions	Rp inch	di mm	l1 mm	l2 mm	l3 mm	b mm	k mm	z1 mm	z2 mm	z4 mm	Pallet/ Pack	Box/M QTY	UOM	Price per m/
1185584	351497802	NEW	16x1/2"/50mm	1/2"	16	55	55	17	40	40	36,5	36,5	13	10	1	pce	POA
1185585	351497902	NEW	16x1/2"/80mm	1/2"	16	55	55	17	40	40	36,5	36,5	13	10	1	pce	POA
1185586	351485820	NEW	20x1/2"/50mm	1/2"	20	55	55	17,5	50	40	42,5	42,5	12,5	10	1	pce	POA

Sanipex Classic

GF JRG Sanipex fitting connector single FT

- Material: gunmetal
- Connection: female thread, cone grip union
- *as long as stock last

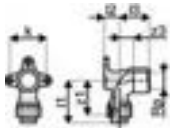

Item No.	Item no. GF	In/Out	Dimensions	Rp inch	di mm	l1 mm	l2 mm	l3 mm	do mm	d mm	k mm	z1 mm	z3 mm	Pallet/ Pack	Box/M QTY	UOM	Price per m/
1185581	351541201	NEW	12x1/2"/33.5mm	1/2"	12	39	17	16,5		40	30	3	20	1	1	pce	POA
1185582	351541202	NEW	12x1/2"/50mm	1/2"	12	39	17	33		40	30	18	10	1	1	pce	POA
1185578	351541602	NEW	16x1/2"/50mm	1/2"	16	45,5	17	33		40	29,5	18	10	1	1	pce	POA
1185583	351541603	NEW	16x1/2"/80mm	1/2"	16	45,5	17	63		40	29,5	18	10	1	1	pce	POA
1185579	351542001	NEW	20x1/2"/35mm	1/2"	20	47	17,5	17,5		40	30	4	20	1	1	pce	POA
1185580	351542002	NEW	20x1/2"/50mm	1/2"	20	47	17,5	32,5		40	30	17,5	10	1	1	pce	POA

GF JRG Sanipex inlay with IG MT

- threaded connection insert
- brass construction
- enables integration with threaded fittings
- suitable for plumbing installations



Item No.	Item no. GF	Dimensions	L mm	W mm	H mm	W kg	Pallet/ Pack	Box/M QTY	UOM	Price per m/each
1158814	358300050	26-1/2	39	32	32	0,06		100	pce	173,33

Teck



Benefits

- Ensures safe and secure water supply
- Certified quality
- Protects inner pipe
- Colour coding for hot and cold water

Uponor Teck are conduit pipes designed to protect multilayer of PE-X pipes used for tap water and heating/cooling applications.

In line with the Water Supply (Water Fittings) Regulation s1999, pipes in solid floors should be able to be withdrawn and replaced if necessary

Specification

- Corrugated, made of high density polyethylene (HDPE)
- Fire class E acc. to BS EN 13501-1
- Supplied in coils.

Application

- Used for pipe in pipe (PIP) installations to reduce the risk for water damages and allow for the flexible media pipe to be replaced

Uponor Teck conduit blue

- corrugated conduit
- colour: blue



Item No.	Dimensions	di mm	do mm	Pallet/ Pack	Box/M QTY	UOM	Price per m/each
1012859	25/20 50m	20	25	2500	50	m	2,02
1012863	28/23 50m	23	28	2000	50	m	2,54

Uponor Teck conduit red

- corrugated conduit
- colour: red

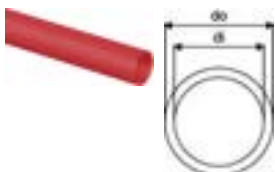

Item No.	Dimensions	di mm	do mm	Pallet/ Pack	Box/M QTY	UOM	Price per m/each
1012858	25/20 50m	20	25	2500	50	m	2,02
1012862	28/23 50m	23	28	2000	50	m	2,54

Uponor Teck conduit black

- corrugated conduit
- colour: black



Item No.	Dimensions	di mm	do mm	Pallet/ Pack	Box/M QTY	UOM	Price per m/each
1012860	25/20 50m	20	25	2500	50	m	2,00
1012864	28/23 50m	23	28	2000	50	m	2,54
1012869	35/29 50m	29	35	1400	50	m	3,70
1012872	43/36 25m	36	43	600	25	m	4,34

Teck

Uponor Teck plugged hook single

- For fixing pipes diameter max 30 mm to the ground
- Made of polypropylene
- Colour: blue
- Drill hole 10 mm

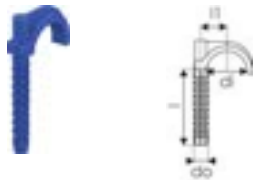

Item No.	Dimensions	di mm	l1 mm	l mm	do mm	h mm	w mm	Pallet/ Pack	Box/M QTY	UOM	Price per m/each
1135511	75	28	18	56	10,5			1600	200	pce	0,66
1135512	90	28	18	76	10,4	13	45	1600	200	pce	0,65

Uponor Teck plugged hook double

- For fixing pipes diameter max 30 mm to the ground
- Made of polypropylene
- Colour: blue
- Drill hole 10 mm



Item No.	Dimensions	di mm	l mm	do mm	k mm	Pallet/ Pack	Box/M QTY	UOM	Price per m/each
1135513	75	28	56	10,5	36	1200	200	pce	0,73
1135514	90	30	81	10,3	36	800	200	pce	0,72

Aqua PLUS



Benefits

- Fast, reliable modular manifolds
- Watertight manifold system for safe on-wall or cabinet installations
- Flexible connections for multiple pipe types and arrangements
- Corrosion-free plastic design for potable water
- Fast, modular installation with standard accessories

Uponor Aqua PLUS PPM is a modular plastic manifold system suitable for both tap water and radiator solutions with a wide range of connection possibilities. Simply align the two parts and twist 180° to lock and seal the assembly.

Application

- Watertight installations to prevent from damages in case of leakage
- All types of manifold installations

Installation is fast and easy, and with the wide range of adapters

available it is possible to connect pipes of different types (Uponor PE-Xa or composite pipes) and dimensions.

Pipes are connected to the manifold with Uponor Q&E and Uponor FPL-X fittings for Uponor PE-Xa pipes, Uponor S-Press fittings for composite pipes, or a combination of these options.

Specification

- For manifolds with c/c 50 mm
- For M7 cabinet sleeves
- Includes cabinet, splash covers and accessories kit with manifold clips
- Doors and frames (if needed) should be ordered separately
- RAL 9010
- Plastic manifolds for installation in Watertight cabinets
- Manifolds and accessories can be used separately
- Metal fittings are made of high quality brass
- Plastic fittings are made of PPSU
- PPM manifolds with bayonet threads

Certification

UK Reg4 approval

- WRAS or
- KIWA

To meet the requirements of the Water Supply (Water Fittings) Regulations 1999

Uponor Aqua PLUS manifold Q&E PPM

- for PPM manifolds

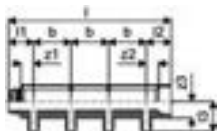

Item No.	Dimensions	l1 mm	l2 mm	l3 mm	l mm	b mm	z1 mm	z2 mm	z3 mm	p bar	Pallet/ Pack	Box/M QTY	UOM	Price per m/each
1047999	1" 2x16 c/c50mm	33,2	33,2	40	116,5	50	16,7	16,7	22	6+10	10	1	pce	20,26
1048000	1" 3x16 c/c50mm	33,2	33,2	40	166,5	50	16,7	16,7	22	6+10	8	1	pce	22,79
1048001	1" 4x16 c/c50mm	33,2	33,2	40	216,5	50	16,7	16,7	22	6+10	6	1	pce	30,41

Aqua PLUS

Uponor Aqua PLUS manifold PPM

- for PPM manifolds

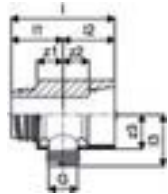

Item No.	Dimensions	G inch	l1 mm	l2 mm	l3 mm	l mm	z1 mm	z2 mm	z3 mm	p bar	Pallet/ Pack	Box/M QTY	UOM	Price per m/
1047997	1" 1xG1/2"MT c/c50mm 1/2"	33,2	33	33	33	66,5	16,7	16,7	22,8	6+10	20	1	pce	17,73
1047998	1" 1xG3/4"MT c/c50mm 3/4"	33,2	33	33	33	66,5	16,7	16,7	22,8	6+10	20	1	pce	19,43

Uponor Aqua PLUS adapter male thread PPM

- for PPM manifolds

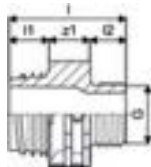

Item No.	Dimensions	G inch	l1 mm	l2 mm	l mm	z1 mm	p bar	Pallet/ Pack	Box/M QTY	UOM	Price per m/each
1048002	1" G3/4"MT 3/4	16,5	15	48,5	17	6+10		20	1	pce	13,93

Uponor Aqua PLUS elbow adapter male PPM

- for PPM manifolds

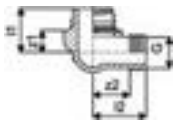

Item No.	Dimensions	G inch	l1 mm	l2 mm	z1 mm	z2 mm	Pallet/ Pack	Box/M QTY	UOM	Price per m/each
1048003	1" G3/4"MT 3/4	33,2	40	16,7	27,8		20	1	pce	14,19

Uponor Aqua PLUS manifold end cap PPM

- for PPM manifolds



Item No.	Dimensions	l mm	z1 mm	Pallet/ Pack	Box/M QTY	UOM	Price per m/each
1048004	1"FT	26,5	14,8	20	1	pce	9,14

Aqua PLUS

Uponor Aqua PLUS end cap, air nipple PPM

- for PPM manifolds

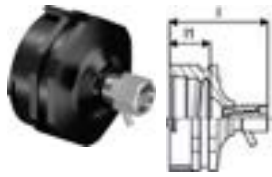

Item No.	Dimensions	l1 mm	l mm	Pallet/ Pack	Box/M QTY	UOM	Price per m/each
1048005	1"FT	16,5	40	20	1	pce	24,16

Uponor Aqua PLUS manifold bracket PPM

- for PPM manifolds



Item No.	di mm	l1 mm	l2 mm	l3 mm	l mm	z mm	b mm	b1 mm	b2 mm	h mm	h1 mm	z1 mm	Pallet/ Pack	Box/M QTY	UOM	Price per m/each
1092021	6	37,5	75	150	36	13,5	123	102	48	58	32	61,5	50	1	set	14,78

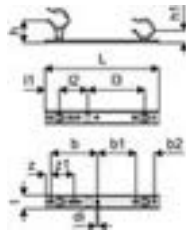

Uponor Aqua PLUS manif end cap flat seal

- Female thread

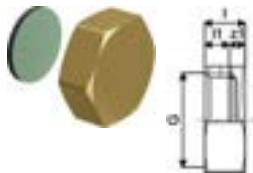

Item No.	Dimensions	G inch	Rp inch	l1 mm	l mm	z1 mm	Pallet/ Pack	Box/M QTY	UOM	Price per m/each
1001337	3/4"FT	3/4	3/4	7	11,5	4,5	250	10	pce	6,39

Flex-X



Benefits

- Simple adaptation to 3/4" Eurocone manifolds and fittings
- No special tools required

Uponor FLEX-X compression fittings are especially designed for the connection of Uponor flexible pipes with the 3/4" Eurocone connection.

Application

- Connection of Uponor flexible PE-Xa pipes to eurocone manifolds
- Use in hot and cold water distribution systems
- Radiator and manifold connections with eurocone interfaces
- Adaptation of flexible PEX pipes to BSP threaded connections

Specification

- Compression fittings for PE-Xa pipes
- Female 3/4" eurocone thread according to BS EN ISO 228-1
- Brass or plated brass construction depending on variant
- BSP threaded adapter options available
- Designed for direct installation without special tools

Uponor Flex-X adapter plated PEX

- Made of plated brass
- For connection of Uponor PE-Xa pipes to manifolds
- Female thread 3/4" Eurocone acc. to BS EN ISO 228-1.



Item No.	Dimensions	G inch	Rp inch	l1 mm	l mm	s mm	z1 mm	p bar	Pallet/ Pack	Box/M QTY	UOM	Price per m/each
1057441	16x1,8/2,0-3/4"FT Euro	0,75	G 3/4	16,3	24	1,8/2,0	1,2	6	100	10	pce	10,33

Uponor Flex-X compression adapter PEX BSP

- Made of brass



Item No.	Dimensions	G inch	l1 mm	l mm	s mm	z1 mm	Pallet/ Pack	Box/M QTY	UOM	Price per m/each
1058934	16x1,8-1/2"FT	0,5	14,6	29	1,8	2,4	150	10	pce	6,51

FPL-X



Benefits

- Reliable mechanical connection without special tools
- High corrosion resistance for long service life
- Suitable for visible radiator and valve installations
- Broad compatibility with Uponor manifolds and accessories
- Flexible solution for renovation and new installations

The FPL-X range consists of compression fittings made of dezincification-resistant brass, designed for connecting Uponor PE-Xa pipes to manifolds, radiator valves and threaded connections.

The FPL-X range enables robust, mechanical connections without the use of press or expansion tools.

Specification

- Compression fittings for Uponor PE-Xa pipes
- Made of dezincification-resistant (DR) brass
- Available with BSP, metric and eurocone-compatible connections
- Variants for WGF, Vario B and other manifold types
- Plated versions available for visible on-wall installations

Application

- Connection of Uponor PE-Xa pipes to manifolds and radiator valves
- Use in hot and cold water distribution systems
- Radiator connections with visible or concealed installations
- Adaptation of PE-Xa pipes to BSP and metric threaded interface

Uponor FPL-X adapter, plated PL

- FPL-X
- Positive listed brass
- Plated nuts for visible installations
- For radiator connections |

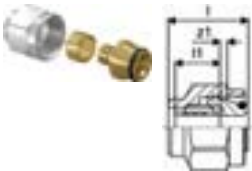

Item No.	Dimensions	G inch	l1 mm	l2 mm	z1 mm	Pallet/ Pack	Box/M QTY	UOM	Price per m/each
1085247	12x1,1-G1/2"FT	1/2	14	25	2,3	50	5	pce	6,01

Uponor FPL-X compression adapter

- Fits 3/4" fittings
- Includes insert, nut, and compression ring



Item No.	Dimensions	G inch	l1 mm	l2 mm	l mm	s mm	Pallet/ Pack	Box/M QTY	UOM	Price per m/each
1009196	20x2,0-G3/4"	0,75	18,7	9	27,7	2,0	50	1	pce	11,40



Benefits

- Low stock costs thanks to modular concept
- One fitting for two types of pipes PB & MLC
- Fast, easy and safe push-fit technology
- No power supply required
- Low tool investments
- Detachable connection

iFIT is an installation system with polybutene and multilayer composite pipes as well as polyphenylsulfone (PPSU) and dezincification-resistant brass modules. The adaptor module technology is a plug-in system that enables safe assembly operations with a minimum number of tools required and no electrical energy. The modular iFIT system makes it possible to work with just a few assortment parts, regardless of dimensions. Two dimensions each fit on the connection section of a module (main body).

Specification

- The iFIT system is subject to constant inspection by internal and external bodies.
- These inspections range from quality assurance during production to ISO certification for
- environmental and process safety. The iFIT system meets the requirements for the most
- important applications in the building technology and is subject to constant monitoring
- by the licensing offices for drinking water and heating installations on land and sea.

Application

- Application area Cold and hot water, HVAC, greywater
-
- Installation Surface and flush-mounted pipes, pipe-in-pipe technology

Certification

- SVGW
- DVGW
- ÖVGW

GF iFIT PE-RT pipe

- Description: Coil
- Material: PE-RT/AL/PE-RT (white)
- PN 16 at 20°C



Item No.	Item no. GF	Dimensions	d mm	L m	PN at 20°C bar	PN s bar mm	Pallet/ Pack	Box/M QTY	UOM	Price per m/each
1151094	762101000	16-2.0 100m	16	100	16	10 2.0	1500	100	m	4,77
1151095	762101001	20-2.0 50m	20	50	16	10 2.0	50	50	m	7,89
1151138	762101130	25-2,5 50m	25	50	16	10 2.5	50	50	m	13,36
1151139	762101131	32-3 50m	32	50	16	10 3.0	50	50	m	19,36

GF iFIT pipe

- Description: in bars
- Material: PE-RT/AL/PE-RT (white)
- PN 16 at 20°C



Item No.	Item no. GF	Dimensions	d mm	L m	PN at 20°C bar	PN s bar mm	Pallet/ Pack	Box/M QTY	UOM	Price per m/each
1151098	762101005	16-2.0 5m	16	5	16	10 2.0	45	5	m	6,87
1151100	762101007	25-2,5 5m	25	5	16	10 2.5	50	5	m	14,49
1151101	762101008	32-3 5m	32	5	16	10 3.0	20	5	m	18,33



GF iFIT pipe insulated S6

- Description: in coils
- Material: PE-RT/AL/PE-RT (white)
- Insulation: W/mK 0.035
- PN 16 at 20°C

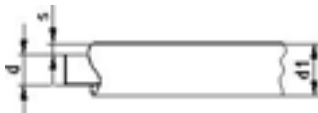

Item No.	Item no. GF	Dimensions	d1 mm	d mm	L m	PN at 20°C bar	PN s1 bar mm	Pallet/ Pack	Box/M QTY	UOM	Price per m/each
1151287	762101365	16-2.0 50m	6	28	16	50	10 6	700	50	m	9,00
1151288	762101366	20-2.0 50m	6	32	20	50	10 6	50	50	m	39,69
1151245	762101314	25-2,5 25m	6	37	25	25	10 6	25	25	m	18,79

GF iFIT adapter

- Material: PPSU, PA
- PN 16 at 20°C

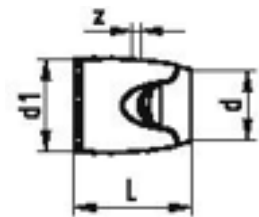

Item No.	Item no. GF	Dimensions	d1 mm	d mm	L mm	z mm	Pallet/ Pack	Box/M QTY	UOM	Price per m/each
1151108	762101030	16	30	16	48	5	150	10	pce	6,43
1151109	762101031	20	34	20	49	5	150	10	pce	7,65
1151111	762101034	25	45	25	62	8	50	5	pce	21,18
1151112	762101035	32	52	32	63	8	50	5	pce	25,02

GF iFit pipe outlet single

- Material: lead-free, DZR brass
- Connection: female thread
- PN 16 at 20°C



Item No.	Item no. GF	Dimensions	z mm	h mm	h1 mm	Pallet/ Pack	Box/M QTY	UOM	Price per m/each	
1151286	762101364	16/20-1/2"	50	12	36	19	50	10	pce	24,72

GF iFIT coupler

- Material: PPSU
- PN 16 at 20°C



Item No.	Item no. GF	Dimensions	d mm	h mm	L mm	PN at 20°C bar	PN bar	Pallet/Pack	Box/M QTY	UOM	Price per m/each
1151116	762101044	16/20	16 - 20	22	43	16	10	500	10	pce	3,56
1151154	762101175	25/32	25 - 32	28	56	16	10	200	5	pce	12,70



GF iFIT reduction

- Material: PPSU
- PN 16 at 20°C



Item No.	Item no. GF	Dimensions	d1 mm	d2 mm	h1 mm	h2 mm	L mm	PN at 20°C bar	PN bar	Pallet/Pack	Box/M QTY	UOM	Price per m/
1151155	762101177	16/20-25/32	25 - 32	16 - 20	32	20	52	16	10	150	2	pce	11,07

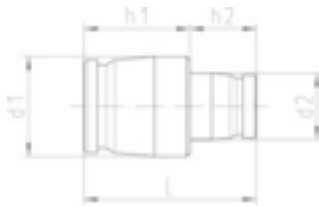

GF iFIT elbow 90deg

- Material: PPSU
- PN 16 at 20°C



Item No.	Item no. GF	Dimensions	d mm	h mm	PN at 20°C bar	PN bar SDR	Pallet/Pack	Box/M QTY	UOM	Price per m/each
1151117	762101046	16/20	16 - 20	36	16	10 11	200	10	pce	5,66
1151156	762101179	25/32	25 - 32	54	16	10 11	100	5	pce	17,83

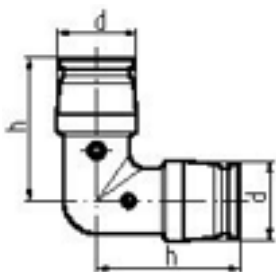

GF iFIT pipe outlet module PPSU 90deg white

- Material: PPSU
- PN 16 at 20°C

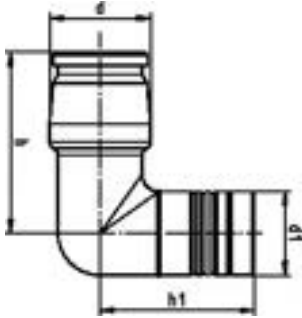

Item No.	Item no. GF	Dimensions	d1 mm	d mm	h1 mm	h mm	PN at 20°C bar	PN bar	Size SDR	Pallet/ Pack	Box/M QTY	UOM	Price per m/	
1151298	762101384	16/20	20	16	20	40	36	16	10 11	20	200	5	pce	11,61
1151299	762101385	25/32	25	25	32	46	54	16	10 11	25	100	2	pce	18,52

GF iFIT tee equal 90deg

- Material: PPSU
- PN 16 at 20°C



Item No.	Item no. GF	Dimensions	d mm	h1 mm	h2 mm	h mm	PN at 20°C bar	PN bar	Pallet/ Pack	Box/M QTY	UOM	Price per m/each
1151115	762101042	16/20	16	20	37	31	16	10	200	10	pce	7,49
1151158	762101181	25/32	25	32	54	45	16	10	60	5	pce	21,54

GF iFIT pipe outl tee equal PPSU white

- Material: PPSU
- PN 16 at 20°C

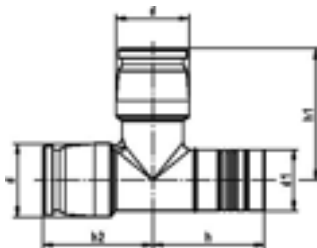

Item No.	Item no. GF	Dimensions	d1 mm	d mm	h1 mm	h2 mm	h mm	PN at 20°C bar	PN bar	Pallet/ Pack	Box/M QTY	UOM	Price per m/each	
1151300	762101386	16/20	20	16/20	20	37	32	41	16	10	140	5	pce	15,17

GF iFIT tee reduced 90deg

- Material: PPSU



Item No.	Item no. GF	Dimensions	d1 mm	d2 mm	d3 mm	h1 mm	h2 mm	h3 mm	PN bar	Pallet/ Pack	Box/M QTY	UOM	Price per m/	
1151161	762101187	16/20-16/20	25/32	25 - 32	16 - 20	16 - 20	45	48	39	10	70	2	pce	15,70
1151160	762101185	25/32-16/20	25/32	25 - 32	16 - 20	25 - 32	45	48	45	10	70	2	pce	17,56

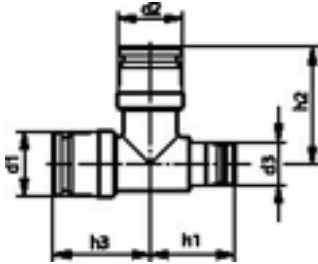

GF iFIT male thread adapter LF

- Material: gunmetal lead-free
 - Connection: male thread
 - PN 16 at 20°C



Item No.	Item no. GF	Dimensions	d mm	h mm	Size inch	Thread Type	Pallet/ Pack	Box/M QTY	UOM	Price per m/each
1151311	762102265	16/20-1/2"	16 - 20	43	1/2	R	50	10	pce	11,53
1151312	762102266	16/20-3/4"	16 - 20	43	3/4	R	50	10	pce	16,35
1151315	762102277	25/32-3/4"	25 - 32	53	3/4	R	20	2	pce	28,05
1151316	762102278	25/32-1"	25 - 32	57	1	R	20	2	pce	35,65

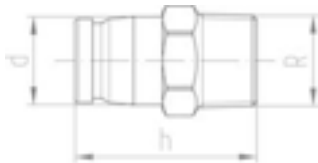

GF iFIT female thread adapter LF

- Material: gunmetal lead-free
 - Connection: female thread
 - PN 16 at 20°C



Item No.	Item no. GF	Dimensions	d mm	h mm	Size inch	Thread Type	z mm	Pallet/ Pack	Box/M QTY	UOM	Price per m/each
1151313	762102267	16/20-1/2"	16 - 20	40	1/2	Rp	23	50	10	pce	14,85
1151317	762102279	25/32-3/4"	25 - 32	48	3/4	Rp	31	20	2	pce	26,55
1151318	762102280	25/32-1"	25 - 32	53	1	Rp	34	20	2	pce	35,76

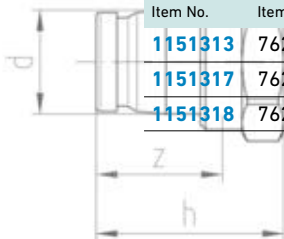

GF iFIT pipe outlet module

- Material: stainless steel
- Connection: male thread



Item No.	Item no. GF	Dimensions	d mm	L mm	PN bar	Size SDR	inch	Thread Type	Pallet/Pack	Box/M QTY	UOM	Price per m/each
1151182	762101238	20-1/2"	20	49	16	11	1/2	R	100	2	pce	26,10

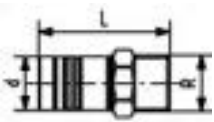

GF iFIT adapter HMS

- Socket fusion transition to iFIT
- Thread in DZR brass, UBA (Umwelt Bundesamt, Germany) conform
- EPDM sealing hot and cold water approved
- Material: brass dezincification resistant, PB
- PN 16 at 20°C



Item No.	Item no. GF	In/Out	Dimensions	d1 mm	d mm	k max. mm	L mm	PN bar	z SDR	Pallet/Pack	Box/M QTY	UOM	Price per m/
1151195	762101254	12.26	20x16/20	16	20	20	23	96	16 11 76	1	1	pce	17,96
1151196	762101255	12.26	25x16/20	16	20	25	23	103	16 11 83	1	1	pce	26,05
1151197	762101256	12.26	25x25/32	25	32	25	23	108	16 11 83	1	1	pce	24,67
1151198	762101257	12.26	32x25/32	25	32	32	21	144	16 11 86	1	1	pce	26,89

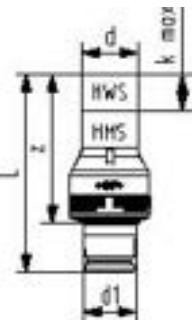

GF iFIT compression adapter LF

- Temperature: max. 90°C
- Material: gunmetal lead-free
- PN 16 at 20°C



Item No.	Item no. GF	Dimensions	d1 mm	d2 mm	L mm	Pallet/ Pack	Box/M QTY	UOM	Price per m/each
1151304	762102190	16/20-15	16	20	15	10	2	pce	28,85
1151305	762102191	16/20-18	16	20	18	20	2	pce	30,78



GF iFIT adapter

- Material: brass
- PN 16 at 20°C



Item No.	Item no. GF	In/Out	Dimensions	d1 mm	d2 mm	z mm	Pallet/ Pack	Box/M QTY	UOM	Price per m/each
1151228	762101292	12.26	16/20-12	16	20	12	10	10	pce	41,98
1151229	762101293	12.26	16/20-15	16	20	15	10	10	pce	44,30

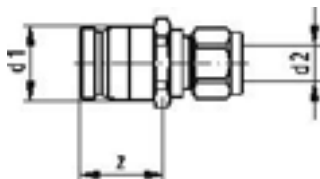

GF iFIT tool set

- d16 / d20 with pipe scissor
- d25 / d32 with pipe cutter



Item No.	Item no. GF	Dimensions	L mm	W mm	H mm	W kg	Pallet/ Pack	Box/M QTY	UOM	Price per m/each
1151133	762101122	16/20	274	224	82	1,163	1	1	pce	658,68
1151141	762101133	25/32	275	224	82	1,371	1	1	pce	621,62

GF iFIT chamfer tool

- Material: steel, plastic



Item No.	Item no. GF	Dimensions	L mm	W mm	H mm	W kg	Pallet/ Pack	Box/M QTY	UOM	Price per m/each
1151129	762101116	16	46	49	107	0,188	1	1	pce	176,40
1151132	762101120	20	49	63	115	0,205	1	1	pce	194,71
1151134	762101125	25	46	46	112	0,252	1	1	pce	179,65
1151140	762101132	32	46	47	120	0,323	1	1	pce	173,55

GF iFIT pipe cutter

- for ML- and PB-pipes



Item No.	Item no. GF	Dimensions	L mm	W mm	H mm	W kg	Pallet/ Pack	Box/M QTY	UOM	Price per m/each
1151130	762101117	16-32	39	64	182	0,386		1	pce	127,82

GF iFIT tool case

- *on request*



Item No.	Item no. GF	Dimensions	L mm	W mm	H mm	W kg	Pallet/ Pack	Box/M QTY	UOM	Price per m/each
1151280	762101358	16-32	300	410	80	4		1	pce	1 483,41

GF iFIT pipe outlet single

- Material: DZR brass
- Connection: female thread
- PN 16 at 20°C



Item No.	Item no. GF	In/Out	Dimensions	d mm	H1 mm	h mm	H mm	remarks	Rp inch	z mm	Pallet/ Pack	Box/M QTY	UOM	Price per m/
1151252	762101321	05.26	16/20-1/2"	16 - 20	19	39	95		1/2	63	20	2	pce	49,97

Instaflex



Benefits

- Flexible
- Flame-free installation
- Noise-insulating
- Full flow design
- Elasticity to follow building shape
- Cost-effective for prefabricated solutions
- One system from supply to the point-of-use

GF INSTAFLEX is a modern, high performance, plastic piping system made of Polybutene used for building services, industrial applications, and in the ship building industry.

Thanks to its flexibility, the sound-absorbing system can easily

be formed to match the contours and turns of a building structure.

Instaflex is also very cost-effective when prefabrication of components is required.

Application

Instaflex offers complete solutions for single-family homes, multi-family residential buildings, healthcare, education, industrial, or commercial building

Application areas

- hot & cold water, compressed air, cooling systems
- Surface and flush-mounted pipelines

Specification

- The system is subject to constant inspection by internal and external bodies.
- These inspections range from quality assurance during production to ISO certification
- for environmental and process safety. The INSTAFLEX system meets all the essential
- requirements for building technology applications and is subject to constant monitoring by the
- licensing offices for drinking water, heating and compressed air installations on land and sea.

Certification

- WRAS material approval (BS6920)

GF Instaflex support carrier galvanised

- Addition: clip
- Ideal for use with Instaflex, Q&E and JRG Sanipex MT
- For diameter \geq d90 no pipe support is required

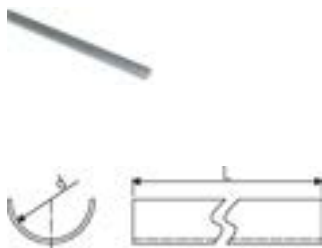

Item No.	Item no. GF	Dimensions	d mm	L mm	Pallet/Pack	Box/M QTY	UOM	Price per m/each
1151746	760856602	16-3m	16	3000	30	3	m	POA
1151747	760856603	20-3m	20	3000	30	3	m	POA
1151748	760856604	25-3m	25	3000	30	3	m	POA
1151749	760856605	32-3m	32	3000	30	3	m	POA
1151697	760854928	40x3m	40	3000	30	3	m	POA
1151698	760854929	50x3m	50	3000	30	3	m	POA
1151699	760854930	63x3m	63	3000	30	3	m	POA
1151708	760854985	75x3m	75	3000	30	3	m	POA

Instaflex

GF Instaflex pipe PB bars

- Packed in cardboard boxes
- Material: PB, single layer pipe
- Operation pressure: 16 bars

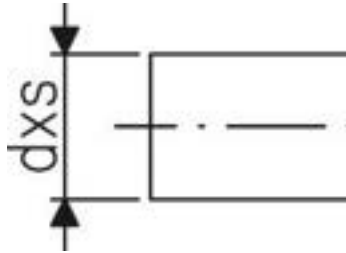

Item No.	Item no. GF	Dimensions	d mm	L m	s mm	Pallet/ Pack	Box/M QTY	UOM	Price per m/each
1151750	760856606	d16	16	5.8	2.2	58	5,80	m	POA
1151751	760856607	d20	20	5.8	2.8	52.2	5,80	m	POA
1151752	760856608	d25	25	5.8	2.3	58	5,80	m	POA
1151753	760856609	d32	32	5.8	2.9	23.2	5,80	m	POA
1151754	760856610	d40	40	5.8	3.7	17.4	5,80	m	POA
1151755	760856611	d50	50	5.8	4.6	17.4	5,80	m	POA
1151756	760856612	d63	63	5.8	5.8	568.4	5,80	m	POA
1151757	760856613	d75	75	5.8	6.8	452.4	5,80	m	POA
1151758	760856614	d90	90	5.8	8.2	278.4	5,80	m	POA
1151759	760856615	d110	110	5.8	10.0	179.8	5,80	m	POA
1151954	761065326	d125	125	5.8	11.4	75.4	5,80	m	POA

GF Instaflex pipe PB

- *as long as stock las



Item No.	Item no. GF	Dimensions	d mm	L m	s mm	Pallet/ Pack	Box/M QTY	UOM	Price per m/each
1151644	760853390	d20 / 60m	20	60	2.8	900	60	m	POA
1151700	760854946	d25 / 30m	25	30	2.3	30	30	m	POA

GF Instaflex elbow 90deg Electro Fusion

- Material: PB
- Operation pressure: 16 bars
- PN 16 at 20°C

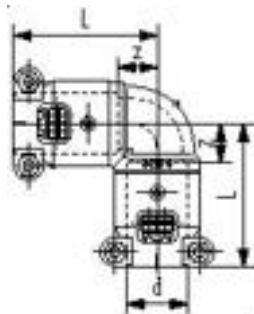

Item No.	Item no. GF	Dimensions	d mm	L mm	z mm	Pallet/ Pack	Box/M QTY	UOM	Price per m/each
1152303	761069214	d16	16	47	10	100	1	pce	POA
1152304	761069215	d20	20	54	14	50	1	pce	POA
1152305	761069216	d25	25	58	16	50	1	pce	POA
1152306	761069217	d32	32	60	18	50	1	pce	POA
1152307	761069218	d40	40	69	22	20	1	pce	POA
1152308	761069219	d50	50	78	29	20	1	pce	POA
1152309	761069220	d63	63	86	36	10	1	pce	POA
1152310	761069221	d75	75	112	45	10	1	pce	POA
1152311	761069222	d90	90	127	54	10	1	pce	POA
1152312	761069223	d110	110	146	66	7	1	pce	POA

GF Instaflex coupler Electro Fusion

- Suitable as sliding coupling
- PN 16 at 20°C

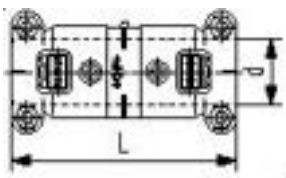

Item No.	Item no. GF	Dimensions	d mm	L mm	Pallet/ Pack	Box/M QTY	UOM	Price per m/each
1152289	761069200	d16	16	76	100	1	pce	POA
1152290	761069201	d20	20	80	100	1	pce	POA
1152291	761069202	d25	25	85	50	1	pce	POA
1152292	761069203	d32	32	85	50	1	pce	POA
1152293	761069204	d40	40	95	25	1	pce	POA
1152294	761069205	d50	50	99	25	1	pce	POA
1152295	761069206	d63	63	102	20	1	pce	POA
1152349	761069265	d75	75	134	10	1	pce	POA
1152350	761069266	d90	90	147	6	1	pce	POA
1152351	761069267	d110	110	160	6	1	pce	POA

GF Instaflex adapter Electro Fusion

- Transition to socket fusion - HMS
- Material: Polybutene (grey)
- PN 16 at 20°C

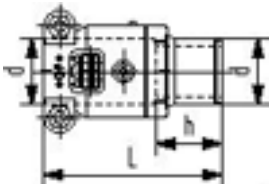

Item No.	Item no. GF	Dimensions	d mm	h mm	L mm	Pallet/ Pack	Box/M QTY	UOM	Price per m/each
1152296	761069207	d16	16	23	60	100	1	pce	POA
1152297	761069208	d20	20	22	61	100	1	pce	POA
1152298	761069209	d25	25	25	67	100	1	pce	POA
1152299	761069210	d32	32	29	71	50	1	pce	POA
1152300	761069211	d40	40	32	79	50	1	pce	POA
1152301	761069212	d50	50	36	85	20	1	pce	POA
1152302	761069213	d63	63	43	94	20	1	pce	POA

GF Instaflex elbow 45deg Electro Fusion i/o

- PN 16 at 20°C

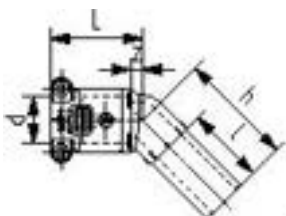

Item No.	Item no. GF	Dimensions	d mm	h mm	l mm	L mm	z mm	Pallet/ Pack	Box/M QTY	UOM	Price per m/each
1152426	761069447	d16	16	50	38	44	6	100	1	pce	POA
1152427	761069448	d20	20	54	40	46	7	100	1	pce	POA
1152428	761069449	d25	25	57	42	50	8	50	1	pce	POA
1152429	761069450	d32	32	60	42	51	9	50	1	pce	POA
1152430	761069451	d40	40	67	47	58	11	30	1	pce	POA
1152431	761069452	d50	50	75	49	63	14	25	1	pce	POA
1152432	761069453	d63	63	79	51	68	17	15	1	pce	POA

GF Instaflex elbow socket-spigot 90deg Electro Fusion

- PN 16 at 20°C

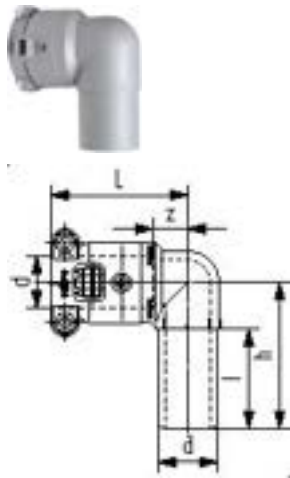

Item No.	Item no. GF	Dimensions	d mm	h mm	l mm	L mm	z mm	Pallet/ Pack	Box/M QTY	UOM	Price per m/each
1152419	761069434	d16	16	53	40	47	10	100	1	pce	POA
1152420	761069435	d20	20	58	40	54	14	50	1	pce	POA
1152421	761069436	d25	25	62	42	58	16	50	1	pce	POA
1152422	761069437	d32	32	66	42	60	18	40	1	pce	POA
1152423	761069438	d40	40	77	47	69	22	35	1	pce	POA
1152424	761069439	d50	50	85	49	78	29	20	1	pce	POA
1152425	761069440	d63	63	96	51	86	36	15	1	pce	POA

GF Instaflex elbow 45deg Electro Fusion

- PN 16 at 20°C



Item No.	Item no. GF	Dimensions	d mm	L mm	z mm	Pallet/ Pack	Box/M QTY	UOM	Price per m/each
1152314	761069228	d20	20	46	7	50	1	pce	POA
1152315	761069229	d25	25	50	8	50	1	pce	POA
1152316	761069230	d32	32	51	9	50	1	pce	POA
1152317	761069231	d40	40	58	11	20	1	pce	POA
1152318	761069232	d50	50	63	14	20	1	pce	POA
1152319	761069233	d63	63	68	17	10	1	pce	POA
1152320	761069234	d75	75	88	21	12	1	pce	POA
1152321	761069235	d90	90	98	25	10	1	pce	POA
1152322	761069236	d110	110	111	31	5	1	pce	POA

GF Instaflex tee equal 90deg Electro Fusion

- PN 16 at 20°C

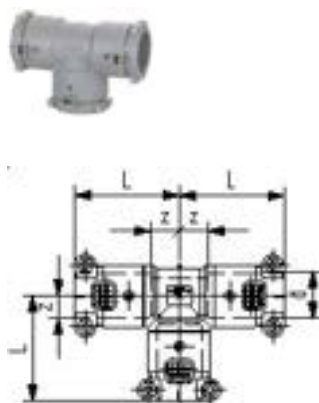

Item No.	Item no. GF	Dimensions	d mm	L mm	z mm	Pallet/ Pack	Box/M QTY	UOM	Price per m/each
1152324	761069238	d20	20	54	14	50	1	pce	POA
1152325	761069239	d25	25	58	16	25	1	pce	POA
1152326	761069240	d32	32	60	18	25	1	pce	POA
1152327	761069241	d40	40	69	22	20	1	pce	POA
1152328	761069242	d50	50	78	29	12	1	pce	POA
1152329	761069243	d63	63	86	36	8	1	pce	POA
1152330	761069244	d75	75	112	45	5	1	pce	POA
1152331	761069245	d90	90	127	54	6	1	pce	POA
1152332	761069246	d110	110	146	66	4	1	pce	POA

GF Instaflex tee reduced 90deg Electro Fusion

- Made of Polybuten
- Electrofusion

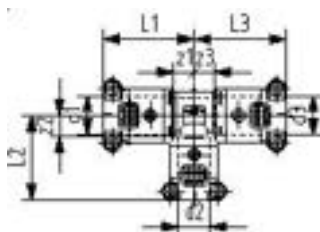

Item No.	Item no. GF	Dimensions	d1	d2	d3	L1	L2	L3	z1	z2	z3	Pallet/ Pack	Box/M QTY	UOM	Price per m/each
1152342	761069258	32-25 25 32	25	25	25	60	58	58	18	16	16	30	1	pce	POA
1152343	761069259	40-20 40 40	20	40	40	69	63	69	22	23	22	20	1	pce	POA
1152348	761069264	63-40 63 63	40	63	63	86	85	86	36	38	36	10	1	pce	POA

GF Instaflex tee reducer 90deg Electro Fusion

- Made of Polybuten
- Electrofusion

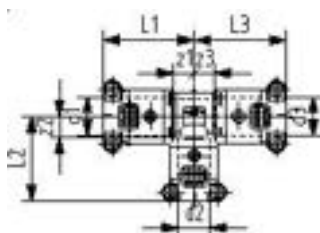

Item No.	Item no. GF	Dimensions	d1	d2	d3	L1	L2	L3	z1	z2	z3	Pallet/ Pack	Box/M QTY	UOM	Price per m/each
1152334	761069250	20-16 20 20	16	20	20	54	49	54	14	11	14	50	1	pce	POA
1152335	761069251	25-16 25 25	16	25	25	58	54	58	16	16	16	50	1	pce	POA
1152340	761069256	25-20 20 25	20	20	20	58	54	54	16	14	14	50	1	pce	POA
1152336	761069252	25-20 25 25	20	25	25	58	54	58	16	14	16	50	1	pce	POA
1152341	761069257	25-25 20 25	25	20	25	58	58	54	16	16	14	50	1	pce	POA
1152337	761069253	32-20 32 32	20	32	32	60	58	60	18	18	18	25	1	pce	POA
1152338	761069254	32-25 32 32	25	32	32	60	58	60	18	16	18	25	1	pce	POA
1152345	761069261	50-25 50 50	25	50	50	78	72	78	29	30	29	16	1	pce	POA
1152346	761069262	50-32 50 50	32	50	50	78	72	78	29	30	29	10	1	pce	POA
1152347	761069263	63-25 63 63	25	63	63	86	81	86	36	39	36	10	1	pce	POA

GF Instaflex tee equal 90deg

- Material: Polybutene

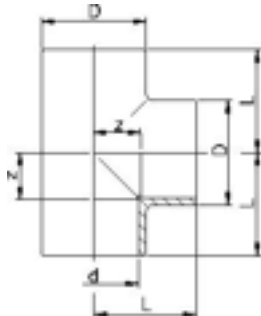

Item No.	Item no. GF	Dimensions	d	D	L	z	Pallet/ Pack	Box/M QTY	UOM	Price per m/each
1152075	761066620	16	16	22	25	10	9600	10	pce	POA
1152076	761066621	20	20	26	28	13	7200	10	pce	POA
1152077	761066622	25	25	32	32	14	4800	10	pce	POA
1152078	761066623	32	32	40	38	18		10	pce	POA
1152079	761066624	40	40	51	44	22	1200	5	pce	POA
1152080	761066625	50	50	64	51	26	720	5	pce	POA
1152081	761066626	63	63	81	62	34	360	2	pce	POA
1152082	761066627	75	75	91	75	44		2	pce	POA
1152083	761066628	90	90	112	88	52		2	pce	POA
1152084	761066629	110	110	132	105	63		2	pce	POA
1151905	761065255	125	125	93	183		4	1	pce	POA

Instaflex

GF Instaflex elbow 90deg

- Material: Polybutene

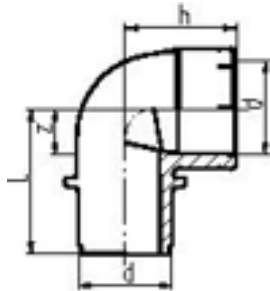

Item No.	Item no. GF	Dimensions	d mm	D mm	h mm	L mm	z mm	Pallet/ Pack	Box/M QTY	UOM	Price per m/each
1151908	761065258	125	125		93	182		6	1	pce	POA

GF Instaflex elbow 45deg

- Material: Polybutene

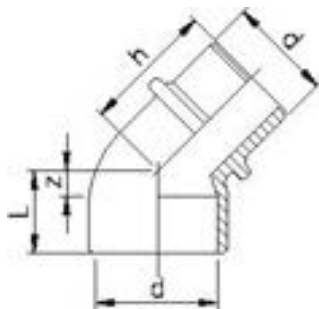

Item No.	Item no. GF	Dimensions	d mm	D mm	h mm	L mm	z mm	Pallet/ Pack	Box/M QTY	UOM	Price per m/each
1151911	761065261	d125	125		92	140		6	1	pce	POA

GF Instaflex tee reduced 90deg MT

- Electro fusion T-piece with transition to male thread
- Thread in DZR brass, UBA listed (Umwelt Bundesamt, Germany)
- EPDM sealing hot and cold water

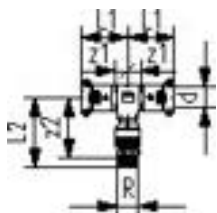

Item No.	Item no. GF	Dimensions	d mm	L1 mm	L2 mm	R mm	z1 inch	z2 mm	Pallet/ Pack	Box/M QTY	UOM	Price per m/each
1152636	761069739	d32	32	60	97	1	18	80		1	pce	POA

Instaflex

GF Instaflex tee adapter 90deg MT

- Electro fusion T-piece with transition to male thread
- Thread in DZR brass, UBA listed (Umwelt Bundesamt, Germany)
- EPDM sealing hot and cold water

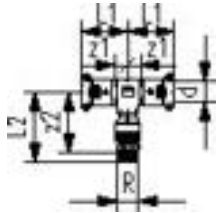

Item No.	Item no. GF	Dimensions	d mm	L1 mm	L2 mm	R mm	inch	z1 mm	z2 mm	Pallet/ Pack	Box/M QTY	UOM	Price per m/each
1152635	761069738	d25	25	58	88	3/4	16	73			1	pce	POA

GF Instaflex cap Electro Fusion

- PN 16 at 20°C

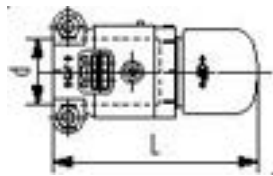

Item No.	Item no. GF	Dimensions	d mm	L mm	Pallet/ Pack	Box/M QTY	UOM	Price per m/each
1152352	761069270	d16	16	67		1	pce	POA
1152353	761069271	d20	20	70		1	pce	POA
1152354	761069272	d25	25	77		1	pce	POA
1152355	761069273	d32	32	83		1	pce	POA
1152356	761069274	d40	40	95		1	pce	POA
1152357	761069275	d50	50	104		1	pce	POA
1152358	761069276	d63	63	116		1	pce	POA

GF Instaflex reducer electro fusion Electro Fusion

- Material: Polybutene (grey)

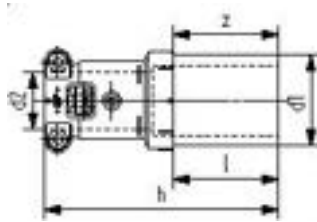

Item No.	Item no. GF	Dimensions	d1 mm	d2 mm	h mm	l mm	z mm	Pallet/ Pack	Box/M QTY	UOM	Price per m/each
1152359	761069277	d20-16	20	16	83	40	45	100	1	pce	POA
1152360	761069278	d25-16	25	16	83	42	46	100	1	pce	POA
1152361	761069279	d25-20	25	20	86	42	47	100	1	pce	POA
1152436	761069457	d32-16	32	16	86	42	48	100	1	pce	POA
1152362	761069280	d32-20	32	20	84	42	45	50	1	pce	POA
1152363	761069281	d32-25	32	25	89	42	47	50	1	pce	POA
1152437	761069458	d40-20	40	20	102	47	62	50	1	pce	POA
1152438	761069459	d40-25	40	25	104	47	62	50	1	pce	POA
1152364	761069282	d40-32	40	32	95	47	53	50	1	pce	POA
1152439	761069460	d50-20	50	20	102	49	62	50	1	pce	POA
1152441	761069462	d50-32	50	32	95	49	53	50	1	pce	POA
1152365	761069283	d50-40	50	40	103	49	56	35	1	pce	POA
1152443	761069464	d63-25	63	25	104	51	62	25	1	pce	POA
1152366	761069284	d63-32	63	32	95	51	53	25	1	pce	POA
1152444	761069465	d63-40	63	40	103	51	56	25	1	pce	POA
1152367	761069285	d63-50	63	50	106	51	57	20	1	pce	POA
1152368	761069286	d75-63	75	63	129	67	78	15	1	pce	POA
1152369	761069287	d90-63	90	63	128	74	77	10	1	pce	POA
1152370	761069288	d90-75	90	75	143	74	76	10	1	pce	POA
1152371	761069289	d110-63	110	63	135	80	84	10	1	pce	POA
1152372	761069290	d110-75	110	75	150	80	83	6	1	pce	POA
1152373	761069291	d110-90	110	90	165	80	92	6	1	pce	POA

GF Instaflex transition

- Material: V4A / 316L

- PN 16 at 20°C

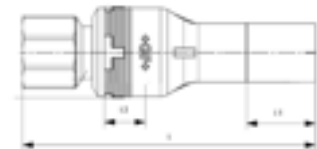

Item No.	Item no. GF	Dimensions	d-d inch/mm	l1 mm	l2 mm	l mm	Pallet/ Pack	Box/M QTY	UOM	Price per m/each
1152670	761069775	d25	3/4 - 25	43	15	104		1	pce	POA
1152671	761069776	d32	1 - 32	43	16	109		1	pce	POA

Instaflex

GF Instaflex adaptor flange

- Suitable for flange or union nut
- Including EPDM O-Ring, quality suitable for potable water
- PN 16 at 20°C
- * on request

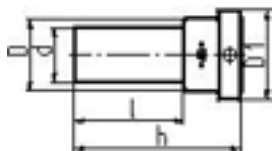

Item No.	Item no. GF	Dimensions	D1 mm	d mm	D mm	h mm	l mm	remarks	Pallet/Pack	Box/M QTY	UOM	Price per m/each
1152377	761069309	d32	50	32	41	78	50	*		1	pce	POA
1152378	761069310	d40	61	40	50	88	56	*		1	pce	POA
1152379	761069311	d50	73	50	61	93	58	*		1	pce	POA
1152380	761069312	d63	90	63	76	98	60	*		1	pce	POA
1152381	761069313	d75	106	75	90	158	118	*		1	pce	POA
1152382	761069314	d90	125	90	109	172	125	*		1	pce	POA
1152383	761069315	d110	150	110	131	186	131	*		1	pce	POA

GF Instaflex adaptor flange flat Electro Fusion

- Suitable for flange or union nut
- PN 16 at 20°C
- * on request

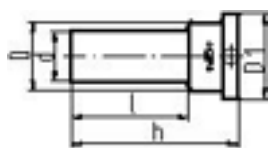

Item No.	Item no. GF	Dimensions	D1 mm	d mm	D mm	h mm	l mm	remarks	Pallet/Pack	Box/M QTY	UOM	Price per m/each
1152384	761069321	d20	34	20	27	67	45	*		1	pce	POA
1152385	761069322	d25	41	25	33	73	50	*		1	pce	POA
1152386	761069323	d32	50	32	41	75	50	*		1	pce	POA
1152387	761069324	d40	61	40	50	83	56	*		1	pce	POA
1152388	761069325	d50	73	50	61	88	58	*		1	pce	POA

GF Instaflex flange adapter Electro Fusion

- Suitable for flange or union nut
- PN 16 at 20°C
- * on request

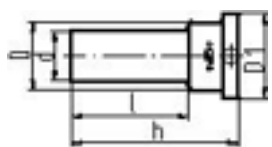

Item No.	Item no. GF	Dimensions	D1 mm	d mm	D mm	h mm	l mm	remarks	Pallet/Pack	Box/M QTY	UOM	Price per m/each
1152389	761069326	d63	90	63	76	93	60			1	pce	POA
1152390	761069327	d75	106	75	90	153	118			1	pce	POA
1152391	761069328	d90	125	90	109	167	125			1	pce	POA
1152392	761069329	d110	150	110	131	180	131			1	pce	POA

GF Instaflex bracket ROM

- For Instaflex pipes



Item No.	Item no. GF	Dimensions	L mm	W mm	H mm	W kg	remarks	Pallet/Pack	Box/M QTY	UOM	Price per m/each
1152716	761070337	125	160	140	30	0,228		30	5	pce	POA

Instaflex

GF Instaflex backing flange

- Material: Casting, GFK coated
- Suitable for flange adaptor
- Tighten the screws with torque as indicated
- Requires standard screws, nuts, washers
- * on request

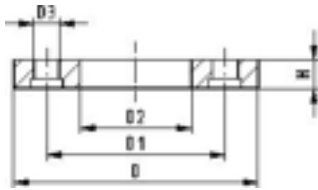

Item No.	Item no. GF	Dimensions	D3 mm	H mm	Pallet/ Pack	Box/M QTY	UOM	Price per m/each
1151920	761065270	d20	105	104	2	2	pce	POA
1151921	761065271	d25	118	117	2	2	pce	POA
1151922	761065272	d32	122	118	2	2	pce	POA
1151923	761065273	d40	143	140	2	2	pce	POA
1151924	761065274	d50	156	155	2	2	pce	POA
1151925	761065275	d63	176	171	2	2	pce	POA
1151926	761065276	d75	190	188	2	2	pce	POA
1151927	761065277	d90	206	205	2	2	pce	POA
1151928	761065278	d110	226	224	2	2	pce	POA

GF Instaflex elbow 90deg Socket Fusion

- Made of Polybuten

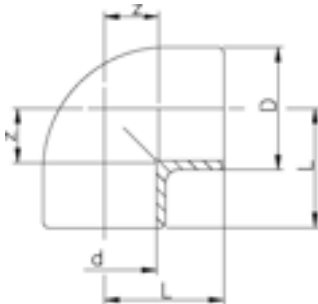

Item No.	Item no. GF	Dimensions	d mm	D mm	L mm	z mm	Pallet/ Pack	Box/M QTY	UOM	Price per m/each
1152055	761066600	d16	16	22	25	10	9600	10	pce	POA
1152056	761066601	d20	20	26	28	13	9600	10	pce	POA
1152057	761066602	d25	25	32	32	14	4800	10	pce	POA
1152058	761066603	d32	32	40	38	18	2100	10	pce	POA
1152059	761066604	d40	40	51	44	22	1800	5	pce	POA
1152060	761066605	d50	50	64	51	26	1200	5	pce	POA
1152061	761066606	d63	63	81	62	34	672	2	pce	POA
1152062	761066607	d75	75	91	75	44	2	2	pce	POA
1152063	761066608	d90	90	108	88	52	2	2	pce	POA
1152064	761066609	d110	110	132	105	63	2	2	pce	POA

GF Instaflex elbow 45deg Socket Fusion

- Made of Polybuten

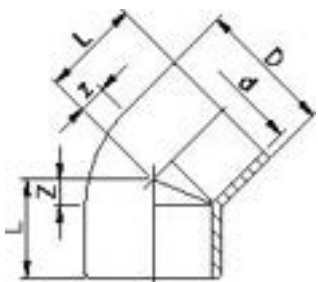

Item No.	Item no. GF	Dimensions	d mm	D mm	L mm	z mm	Pallet/ Pack	Box/M QTY	UOM	Price per m/each
1152066	761066611	d20	20	26	22	7	9600	10	pce	POA
1152067	761066612	d25	25	32	25	7	7200	10	pce	POA
1152068	761066613	d32	32	40	30	10	3600	10	pce	POA
1152069	761066614	d40	40	51	34	12	2160	5	pce	POA
1152070	761066615	d50	50	64	39	14	1260	5	pce	POA
1152071	761066616	d63	63	81	45	17	576	2	pce	POA
1152072	761066617	d75	75	92	51	20	2	2	pce	POA
1152073	761066618	d90	90	109	58	22	2	2	pce	POA
1152074	761066619	d110	110	134	68	26	2	2	pce	POA

Instaflex

GF Instaflex tee reduced 90deg

- Made of Polybuten

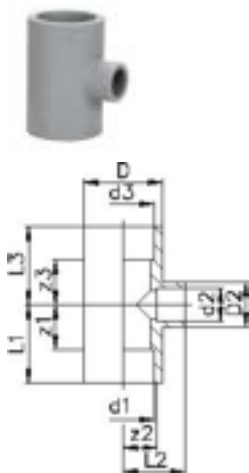

Item No.	Item no. GF	Dimensions	d1	d2	D2	d3	D	L1	L2	L3	z1	z2	z3	Pallet/ Pack	Box/M QTY	UOM	Price per m/
1152202	761066917	25-16	25	16	26	25	32	32	32	32	14	17	14		10	pce	POA
1152203	761066918	25-20	25	20	26	25	32	32	32	32	14	17	14	3600	10	pce	POA
1152207	761066922	32-20	32	20	26	32	40	38	38	38	18	23	18	2880	5	pce	POA
1152208	761066923	32-25	32	25	32	32	40	38	38	38	18	20	18	2700	10	pce	POA
1152209	761066924	40-25	40	25	34	40	51	44	44	44	22	26	22		5	pce	POA
1152268	761068049	40-32	40	32	40	40	51	44	44	44	22	24	22	250	5	pce	POA
1152210	761066925	50-25	50	25	34	50	64	51	51	51	26	33	26	720	5	pce	POA
1152269	761068050	50-32	50	32	40	50	64	51	51	51	26	31	26	250	5	pce	POA
1152211	761066926	63-25	63	25	35	63	81	62	62	62	34	44	34	360	5	pce	POA
1152270	761068051	63-32	63	32	40	63	81	62	62	62	34	42	34		5	pce	POA

GF Instaflex socket Socket Fusion

- PN 16 at 20°C

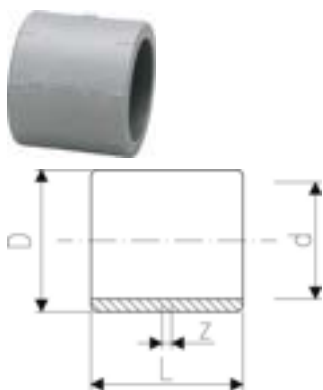

Item No.	Item no. GF	Dimensions	d	D	L	z	Pallet/ Pack	Box/M QTY	UOM	Price per m/each
1152113	761066661	d20	20	26	33	3		10	pce	POA
1152114	761066662	d25	25	32	39	3		10	pce	POA
1152115	761066663	d32	32	40	43	3		10	pce	POA
1152116	761066664	d40	40	51	48	4		10	pce	POA
1152117	761066665	d50	50	64	54	4	1800	10	pce	POA
1152118	761066666	d63	63	81	60	4	1080	2	pce	POA
1152119	761066667	d75	75	91	69	7		2	pce	POA
1152120	761066668	d90	90	110	80	8		2	pce	POA
1152121	761066669	d110	110	133	94	10		2	pce	POA

GF Instaflex reduction bush Socket Fusion

- Made of Polybuten

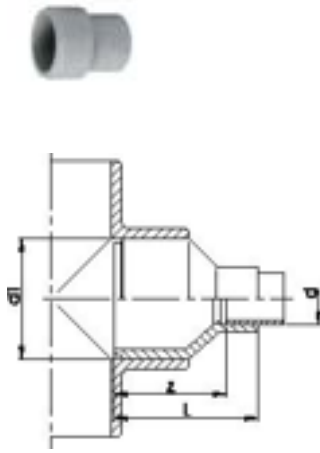

Item No.	Item no. GF	Dimensions	d1 mm	d mm	L mm	z mm	Pallet/ Pack	Box/M QTY	UOM	Price per m/each
1152122	761066670	d20-16	20	16	30	15		10	pce	POA
1152124	761066672	d25-20	25	20	33	18		10	pce	POA
1152125	761066674	d32-20	32	20	40	25	4500	10	pce	POA
1152126	761066675	d32-25	32	25	40	22		10	pce	POA
1152127	761066677	d40-20	40	20	42	27	7200	10	pce	POA
1152128	761066678	d40-25	40	25	42	24	7200	10	pce	POA
1152129	761066679	d40-32	40	32	42	22	1800	10	pce	POA
1152130	761066681	d50-20	50	20	55	40	3600	10	pce	POA
1152131	761066682	d50-25	50	25	55	37		10	pce	POA
1152132	761066683	d50-32	50	32	55	35	3600	10	pce	POA
1152133	761066684	d50-40	50	40	55	33	2700	10	pce	POA
1152134	761066686	d63-20	63	20	58	43		5	pce	POA
1152135	761066687	d63-25	63	25	58	40	2700	5	pce	POA
1152136	761066688	d63-32	63	32	58	38	2700	10	pce	POA
1152137	761066689	d63-40	63	40	58	36		5	pce	POA
1152138	761066690	d63-50	63	50	58	33	1800	5	pce	POA

GF Instaflex reduction bush Socket Fusion

- PN 16 at 20°C

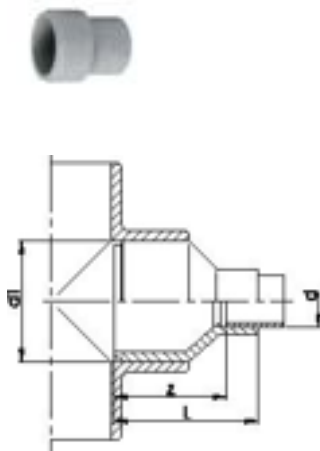

Item No.	Item no. GF	Dimensions	d1 mm	d mm	L mm	z mm	Pallet/ Pack	Box/M QTY	UOM	Price per m/each
1152149	761066742	d75-63	75	63	67	39		2	pce	POA
1152151	761066746	d90-63	90	63	74	46	736	2	pce	POA
1152150	761066745	d90-75	90	75	74	43	768	2	pce	POA
1152152	761066747	d110-63	110	63	86	58	432	2	pce	POA
1152154	761066749	d110-75	110	75	86	55		2	pce	POA
1152153	761066748	d110-90	110	90	86	50	432	2	pce	POA

Instaflex

GF Instaflex cap

- Made of Polybuten

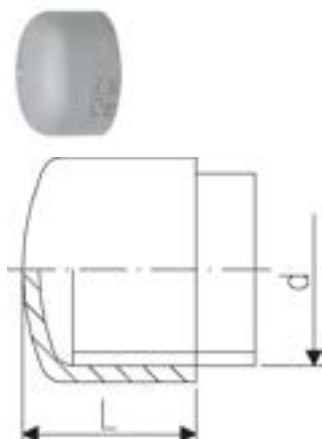

Item No.	Item no. GF	Dimensions	d mm	L mm	Pallet/ Pack	Box/M QTY	UOM	Price per m/each
1152107	761066652	d25	25	28	9600	10	pce	POA
1152108	761066653	d32	32	32		10	pce	POA
1152109	761066654	d40	40	38	3600	10	pce	POA
1152110	761066655	d50	50	44	2700	10	pce	POA
1152111	761066656	d63	63	50	1350	5	pce	POA

GF Instaflex cap Socket Fusion

- Made of Polybuten

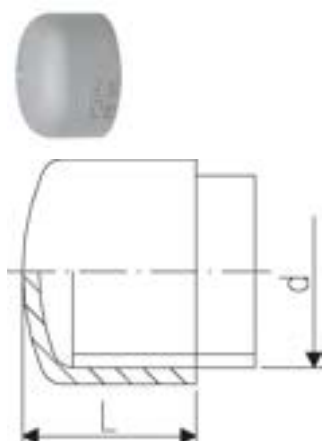

Item No.	Item no. GF	Dimensions	d mm	L mm	Pallet/ Pack	Box/M QTY	UOM	Price per m/each
1152105	761066650	d16	16	22		10	pce	POA
1152106	761066651	d20	20	24		10	pce	POA

GF Instaflex weld-in-saddle Socket Fusion

- * on request

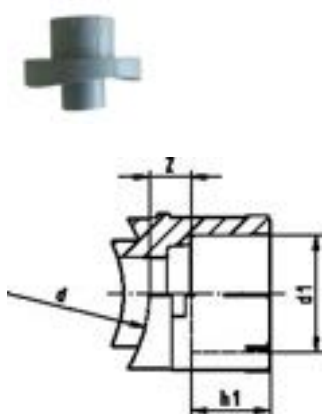

Item No.	Item no. GF	Dimensions	d - d1 mm	h1 mm	remarks	z mm	Pallet/ Pack	Box/M QTY	UOM	Price per m/each
1152227	761068000	40-20	40 - 20	15	*	11	7200	5	pce	POA
1152228	761068003	50-20	50 - 20	15		11		5	pce	POA
1152229	761068004	50-25	50 - 25	18		11		5	pce	POA
1152230	761068005	50-32	50 - 32	20		11		5	pce	POA
1152231	761068006	63-20	63 - 20	15		11		5	pce	POA
1152232	761068007	63-25	63 - 25	18		11		5	pce	POA
1152233	761068008	63-32	63 - 32	20		11	5400	5	pce	POA
1152234	761068009	75-20	75 - 20	15		12	7200	5	pce	POA
1152235	761068010	75-25	75 - 25	18		12	7200	5	pce	POA
1152236	761068011	75-32	75 - 32	20		12	4800	5	pce	POA
1152237	761068012	90-20	90 - 20	15		13	7200	5	pce	POA
1152239	761068014	90-32	90 - 32	20		13	4800	5	pce	POA
1152241	761068016	110-25	110 - 25	18		14		5	pce	POA
1152243	761068018	125-32	125 - 32	20		16	3600	5	pce	POA

Instaflex

GF Instaflex flange adapter

- Suitable for flange or union nut

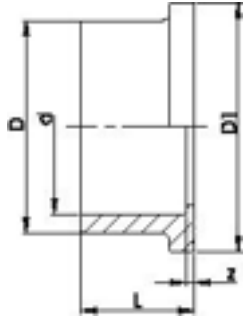

Item No.	Item no. GF	Dimensions	D1 mm	d mm	D mm	L mm	z mm	Pallet/ Pack	Box/M QTY	UOM	Price per m/each
1152090	761066635	d50	73	50	61	30	5	2700	10	pce	POA
1152091	761066636	d63	90	63	76	33	5	1620	2	pce	POA

GF Instaflex flange adapter socket fusion

- Suitable for flange or union nut

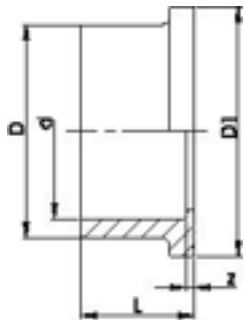

Item No.	Item no. GF	Dimensions	D1 mm	d mm	D mm	L mm	z mm	Pallet/ Pack	Box/M QTY	UOM	Price per m/each
1152092	761066637	d75	106	75	90	35	4		2	pce	POA
1152093	761066638	d90	125	90	109	42	6		2	pce	POA
1152094	761066639	d110	150	110	131	49	7		2	pce	POA

GF Instaflex transition FT

- Material: Brass UBA listed

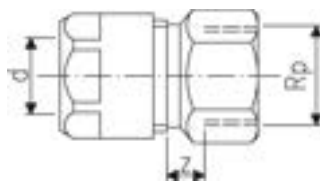

Item No.	Item no. GF	Dimensions	d mm	Rp inch	z mm	Pallet/ Pack	Box/M QTY	UOM	Price per m/each
1151773	760857019	16-1/2"	16	1/2	12	50	5	pce	POA
1151774	760857020	16-3/4"	16	3/4	15	40	5	pce	POA
1151775	760857021	20-1/2"	20	1/2	14	40	5	pce	POA
1151776	760857022	20-3/4"	20	3/4	15	40	5	pce	POA

Instaflex

GF Instaflex transition FT

- Material: Brass UBA listed
- *as long as stock last

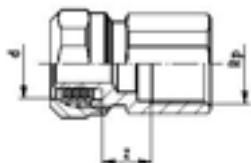

Item No.	Item no. GF	Dimensions	d mm	remarks	Remarks	Rp inch	z mm	Pallet/ Pack	Box/M QTY	UOM	Price per m/each
1151778	760857024	25-1"	25			1	13		10	pce	POA
1151777	760857023	25-3/4"	25			3/4	7	10	1	pce	POA
1151779	760857025	32-1"	32			1	7		10	pce	POA
1151780	760857026	40-1 1/4"	40			1 1/4	7		1	pce	POA
1151781	760857027	50-1 1/2"	50			1 1/2	7		1	pce	POA
1151782	760857028	63-2"	63			2	9	10	1	pce	POA

GF Instaflex transition MT

- Material: Brass UBA listed

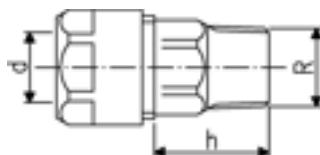

Item No.	Item no. GF	Dimensions	d mm	h mm	R inch	remarks	Remarks	Pallet/ Pack	Box/M QTY	UOM	Price per m/each
1151786	760857032	16-1/2"	16	30	1/2			50	5	pce	POA
1151787	760857033	16-3/4"	16	34	3/4				5	pce	POA
1151788	760857034	20-1/2"	20	38	1/2			35	5	pce	POA

GF Instaflex transition MT

- Material: Brass UBA listed

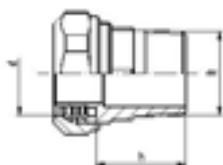

Item No.	Item no. GF	Dimensions	d mm	h mm	R inch	remarks	Remarks	Pallet/ Pack	Box/M QTY	UOM	Price per m/each
1151790	760857036	25-3/4"	25	35	3/4			10	1	pce	POA
1151791	760857037	25-1"	25	41	1				10	pce	POA
1151792	760857038	32-1"	32	42	1				1	pce	POA
1151793	760857039	40-1 1/4"	40	44	1 1/4			10	1	pce	POA
1151794	760857040	50-1 1/2"	50	47	1 1/2				1	pce	POA
1151795	760857041	63-2"	63	32	2			10	1	pce	POA

GF Instaflex clamping ring

- Made of Brass

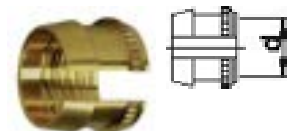

Item No.	Item no. GF	Dimensions	L mm	W mm	H mm	W kg	remarks	Remarks	Pallet/ Pack	Box/M QTY	UOM	Price per m/each
1151602	760853019	16	22	21	16	0,011				5	pce	POA

GF Instaflex cap with seal

- Including seal



Item No.	Item no. GF	Dimensions	L mm	W mm	H mm	W kg	Pallet/ Pack	Box/M QTY	UOM	Price per m/each
1151820	760857073	d20	31	33	33	0,094		5	pce	POA

GF Instaflex gasket

- Material: CNAF fibre washer acc. to DIN 3754



Item No.	Item no. GF	Dimensions	L mm	W mm	H mm	W kg	Pallet/ Pack	Box/M QTY	UOM	Price per m/each
1151603	760853021	16-20	16	14	3	0,002		5	pce	POA

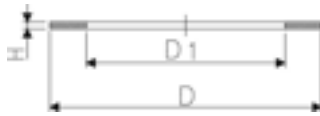

GF Instaflex straight thread MT

- Socket fusion transition to male thread
- Thread in DZR brass, UBA listed
- Gasket: EPDM
- Material: PB, Brass
- Operating pressure: 16 bars

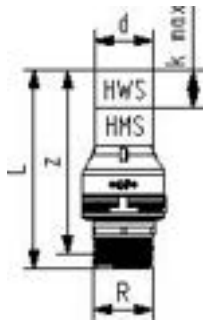

Item No.	Item no. GF	Dimensions	d mm	k max. mm	L mm	R inch	z mm	Pallet/ Pack	Box/M QTY	UOM	Price per m/each
1152563	761069666	16-1/2"	16	22	96	1/2	83		1	pce	POA
1152564	761069667	20-1/2"	20	24	99	1/2	86		1	pce	POA
1152565	761069668	20-3/4"	20	24	101	3/4	86		1	pce	POA
1152567	761069670	25x1"	25	23	107	1	90		1	pce	POA
1152566	761069669	25x3/4"	25	23	104	3/4	89		1	pce	POA
1152568	761069671	32x1"	32	21	111	1	94		1	pce	POA
1152569	761069672	40x1 1/4"	40	24	133	1 1/4	114		1	pce	POA
1152570	761069673	50x1 1/2"	50	22	138	1 1/2	119		1	pce	POA
1152571	761069674	63x2"	63	21	156	2	132		1	pce	POA

Instaflex

GF Instaflex flange adapter socket fusion FT

- Socket fusion transition to male thread
- Thread in DZR brass, UBA listed
- Gasket: EPDM
- Material: PB, Brass
- Operating pressure: 16 bars



Item No.	Item no. GF	Dimensions	d mm	k max. mm	L mm	remarks	Rp inch	z mm	Pallet/ Pack	Box/M QTY	UOM	Price per m/each
1152572	761069675	16x1/2"	16	22	97		1/2	84		1	pce	POA
1152573	761069676	20x1/2"	20	23	100 *		1/2	87		1	pce	POA

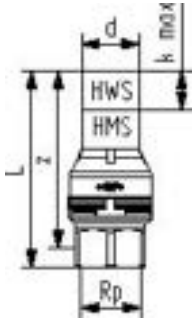

GF Instaflex straight thread socket fusion FT

- Socket fusion transition to female thread
- Thread in DZR brass, UBA listed
- Gasket: EPDM
- Material: PB, Brass
- Operating pressure: 16 bars



Item No.	Item no. GF	Dimensions	d mm	k max. mm	L mm	Rp inch	z mm	Pallet/ Pack	Box/M QTY	UOM	Price per m/each
1152574	761069677	20x3/4"	20	23	100	3/4	85		1	pce	POA

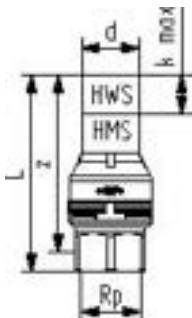

GF Instaflex straight thread FT

- Socket fusion transition to female thread
- Thread in DZR brass, UBA listed
- Gasket: EPDM
- Material: PB, Brass

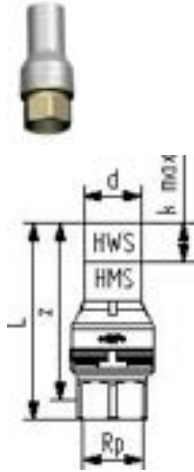

Item No.	Item no. GF	Dimensions	d mm	k max. mm	L mm	Rp inch	z mm	Pallet/Pack	Box/M QTY	UOM	Price per m/each
1152576	761069679	25x1"FT	25	23	108	1	91		1	pce	POA
1152575	761069678	25x3/4"	25	23	104	3/4	89		1	pce	POA
1152577	761069680	32x1"	32	21	109	1	92		1	pce	POA
1152578	761069681	40x1 1/4"	40	24	130	1 1/4	111		1	pce	POA
1152579	761069682	50x1 1/2"	50	22	135	1 1/2	116		1	pce	POA
1152580	761069683	63x2"	63	21	148	2	124		1	pce	POA

GF Instaflex adapter FT

- Socket fusion transition to female thread
- Thread in DZR brass, UBA listed
- Gasket: EPDM
- Material: PB, Brass

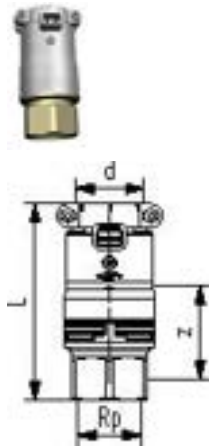

Item No.	Item no. GF	Dimensions	d mm	L mm	Rp inch	z mm	Pallet/Pack	Box/M QTY	UOM	Price per m/each
1152602	761069705	25x3/4"	25	95	3/4	37		1	pce	POA
1152603	761069706	25x1"	25	100	1	39		1	pce	POA
1152604	761069707	32x1"	32	100	1	39		1	pce	POA
1152605	761069708	d40	40	119	1 1/4	51		1	pce	POA
1152606	761069709	d50	50	124	1 1/2	56		1	pce	POA
1152607	761069710	63x2"	63	142	2	65		1	pce	POA

GF Instaflex flange adapter electro fusion FT

- Socket fusion transition to female thread
- Thread in DZR brass, UBA listed
- Gasket: EPDM
- Material: PB, Brass



Item No.	Item no. GF	Dimensions	d mm	L mm	Rp inch	z mm	Pallet/ Pack	Box/M QTY	UOM	Price per m/each
1152599	761069702	16x1/2"	16	88	1/2	35		1	pce	POA
1152600	761069703	20x1/2"	20	91	1/2	37		1	pce	POA

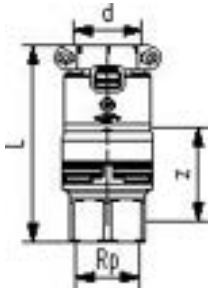

GF Instaflex straight thread electro fusion FT

- Socket fusion transition to female thread
- Thread in DZR brass, UBA listed
- Gasket: EPDM
- Material: PB, Brass



Item No.	Item no. GF	Dimensions	d mm	L mm	Rp inch	z mm	Pallet/ Pack	Box/M QTY	UOM	Price per m/each
1152601	761069704	20x3/4"	20	91	3/4	35		1	pce	POA

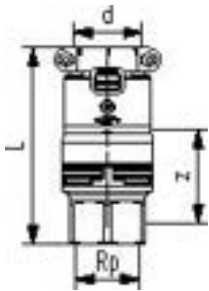

GF Instaflex adapter MT

- Socket fusion transition to male thread
- Thread in DZR brass, UBA listed
- Gasket: EPDM
- Material: PB, Brass

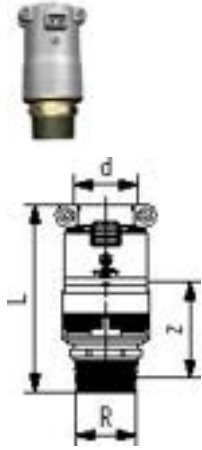

Item No.	Item no. GF	Dimensions	d mm	L mm	R inch	z mm	Pallet/ Pack	Box/M QTY	UOM	Price per m/each
1152608	761069711	16x1/2"	16	87	1/2	36		1	pce	POA
1152609	761069712	20x1/2"	20	90	1/2	37		1	pce	POA
1152610	761069713	20x3/4"	20	92	3/4	38		1	pce	POA
1152612	761069715	25x1"	25	98	1	39		1	pce	POA
1152611	761069714	25x3/4"	25	96	3/4	39		1	pce	POA
1152613	761069716	32x1"	32	102	1	43		1	pce	POA
1152614	761069717	d40x5/4"	40	122	1 1/4	56		1	pce	POA
1152615	761069718	d50x1 1/2"	50	127	1 1/2	61		1	pce	POA
1152616	761069719	63x2"	63	150	2	76		1	pce	POA

GF Instaflex adapter / flat seal

- Socket fusion transition to lose-nut adapter
- Thread in DZR brass, UBA listed
- Gasket: EPDM
- Material: PB, Brass
- PN 16 at 20°C

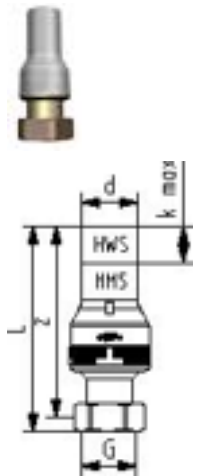

Item No.	Item no. GF	Dimensions	d mm	G inch	k max. mm	L min. mm	SF mm	L mm	z mm	Pallet/ Pack	Box/M QTY	UOM	Price per m/each
1152585	761069688	25x1"	25	1	23	20	110	102			1	pce	POA

Instaflex

GF Instaflex adapter / flat seal

- Socket fusion transition to lose-nut adapter
- Thread in DZR brass, UBA listed
- Gasket: EPDM
- Material: PB, Brass
- PN 16 at 20°C

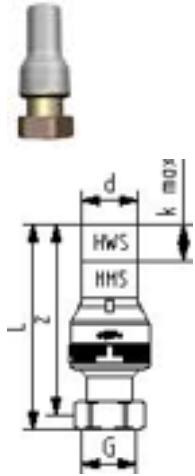

Item No.	Item no. GF	Dimensions	d mm inch	G mm inch	k max. mm	L min. mm	SF mm	L mm	z mm	Pallet/ Pack	Box/M QTY	UOM	Price per m/each
1152582	761069685	20x3/4" 94L	20	3/4	24	16		102	94		1	pce	POA
1152586	761069689	25x1 1/4"	25	1 1/4	23	20		118	109		1	pce	POA
1152588	761069691	32x1 1/4"	32	1 1/4	21	22		118	110		1	pce	POA
1152589	761069692	32x1 1/2"	32	1 1/2	21	22		119	110		1	pce	POA
1152590	761069693	40x1 1/4"	40	1 1/4	24	26		134	105		1	pce	POA
1152591	761069694	40x1 1/2"	40	1 1/2	24	24		132	124		1	pce	POA
1152593	761069696	50x1 3/4"	50	1 3/4	22	28		142	131		1	pce	POA
1152594	761069697	50x2 1/4"	50	2 1/4	22	28		150	138		1	pce	POA
1152595	761069698	63x2 3/8"	63	2 3/8	21	30		159	147		1	pce	POA

GF Instaflex union long MT

- Spigot for electro fusion and socket fusion - male thread
- O-ring, EPDM

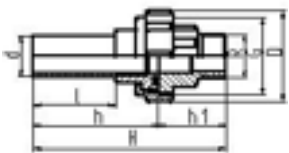

Item No.	Item no. GF	In/Out	Dimensions	d mm mm	D mm mm	G inch	h1 mm mm	h mm mm	H mm mm	l mm mm	R inch	remarks	Pallet/ Pack	Box/M QTY	UOM	Price per m/
1151859	760857201	OUT	20-1/2"	20	46	1 1/4	40	70	110	47	1/2	*		1	pce	POA
1151860	760857202	OUT	25-3/4"	25	52	1 1/2	41	76	117	50	3/4	*		1	pce	POA
1151861	760857203	OUT	32-1"	32	64	2	45	78	123	50	1	*		1	pce	POA
1151862	760857204	OUT	40-1 1/4"	40	79	2 1/2	48	88	136	56	1 1/4	*		1	pce	POA
1151863	760857205	OUT	50-1 1/2"	50	85	2 3/4	48	93	141	58	1 1/2	*		1	pce	POA

GF Instaflex adapter MT

- O-ring, EPDM

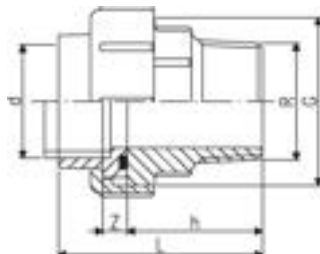

Item No.	Item no. GF	Dimensions	d mm	G inch	h mm	L mm	R inch	z mm	Pallet/ Pack	Box/M QTY	UOM	Price per m/each
1151825	760857155	16-1/2"	16	1	38	61	1/2	8		10	pce	POA
1151826	760857156	20-1/2"	20	1 1/4	40	63	1/2	8		10	pce	POA
1151827	760857157	25-3/4"	25	1 1/2	41	67	3/4	8		10	pce	POA
1151828	760857158	32-1"	32	2	45	73	1	8		5	pce	POA
1151829	760857159	40-1 1/4"	40	2 1/2	48	80	1 1/4	10		5	pce	POA
1151830	760857160	50-1 1/2"	50	2 3/4	48	83	1 1/2	10		2	pce	POA
1151831	760857161	63-2"	63	3 1/2	54	92	2	10		2	pce	POA

GF Instaflex adapter FT

- O-ring, EPDM

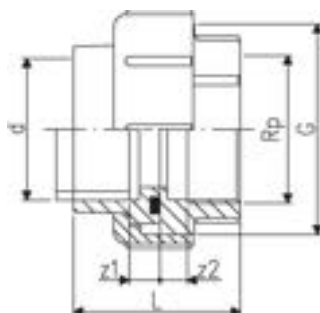

Item No.	Item no. GF	Dimensions	d mm	G inch	L mm	Remarks	Rp inch	z1 mm	z2 mm	Pallet/ Pack	Box/M QTY	UOM	Price per m/each
1151832	760857162	16-1/2"	16	1	45	*	1/2	8	9		10	pce	POA
1151833	760857163	20-1/2"	20	1 1/4	47		1/2	8	10		10	pce	POA
1151834	760857164	25-3/4"	25	1 1/2	50		3/4	8	9		10	pce	POA
1151835	760857165	32-1"	32	2	53		1	8	8		5	pce	POA
1151836	760857166	40-1 1/4"	40	2 1/2	58		1 1/4	10	7		5	pce	POA
1151837	760857167	50-1 1/2"	50	2 3/4	61		1 1/2	10	7		2	pce	POA
1151838	760857168	63-2"	63	3 1/2	66		2	10	9		2	pce	POA

GF Instaflex union Electro Fusion, MT

- O-ring, EPDM

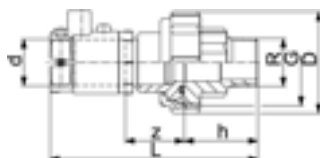

Item No.	Item no. GF	Dimensions	d mm	D mm	G inch	h mm	L mm	R inch	z mm	Pallet/ Pack	Box/M QTY	UOM	Price per m/each
1151872	760857214	16-1/2"	16	41	1	38	106	1/2	31		1	pce	POA
1151873	760857215	20-1/2"	20	50	1 1/4	40	109	1/2	30		1	pce	POA
1151874	760857216	25-3/4"	25	56	1 1/2	41	116	3/4	33		1	pce	POA
1151875	760857217	32-1"	32	69	2	45	124	1	37		1	pce	POA
1151876	760857218	40-1 1/4"	40	83	2 1/2	48	137	1 1/4	42		1	pce	POA
1151877	760857219	50-1 1/2"	50	90	2 3/4	48	143	1 1/2	46		1	pce	POA
1151878	760857220	63-2"	63	110	3 1/2	54	158	2	53		1	pce	POA

Instaflex

GF Instaflex union Electro Fusion, FT

- O-ring, EPDM
- PN16 at 20°C

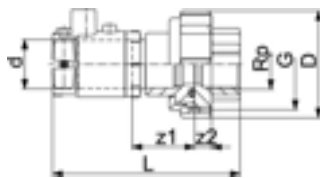

Item No.	Item no. GF	Dimensions	d mm	D mm	G inch	L mm	Rp inch	z1 mm	z2 mm	Pallet/Pack	Box/M QTY	UOM	Price per m/each
1151879	760857221	16-1/2"	16	41	1	90	1/2	31	9	50	1	pce	POA
1151880	760857222	20-1/2"	20	50	1 1/4	93	1/2	30	10		1	pce	POA
1151881	760857223	25-3/4"	25	56	1 1/2	99	3/4	33	9		1	pce	POA
1151882	760857224	32-1"	32	69	2	104	1	37	8		1	pce	POA
1151883	760857225	40-1 1/4"	40	83	2 1/2	115	1 1/4	42	7		1	pce	POA
1151885	760857227	63-2"	63	110	3 1/2	132	2	53	5		1	pce	POA

GF Instaflex union

- O-ring, EPDM
- PN16 at 20°C

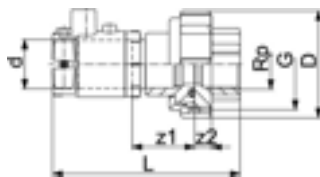

Item No.	Item no. GF	Dimensions	d mm	D mm	G inch	L mm	Rp inch	z1 mm	z2 mm	Pallet/Pack	Box/M QTY	UOM	Price per m/each
1151884	760857226	50-1 1/2"	50	90	2 3/4	121	1 1/2	46	7		1	pce	POA

GF Instaflex O-ring

- O-ring, EPDM

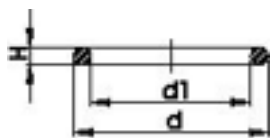

Item No.	Item no. GF	Dimensions	d1 mm	d mm	D mm	H mm	Pallet/Pack	Box/M QTY	UOM	Price per m/each
1151995	761066128	d50	53	50	64	5		1	pce	POA
1151996	761066129	d63	69	63	80	5		1	pce	POA
1152675	761070036	d75	82	75	93	5		1	pce	POA
1152676	761070037	d90	101	90	112	5		1	pce	POA
1152677	761070038	d110	120	110	134	7		1	pce	POA

GF Instaflex valve BTV 2 Electro Fusion

- Material: PB, brass, gunmetal
- Connection: for electrofusion
- Brass: UBA listed
- Gasket: EPDM

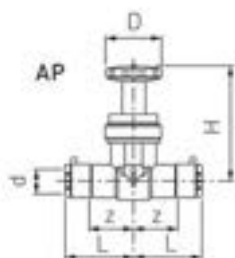

Item No.	Item no. GF	Dimensions	d mm	D mm	DN mm	H mm	L mm	z mm	Pallet/ Pack	Box/M QTY	UOM	Price per m/each
1152545	761069647	d20	20	55	15	112	86	47	6	1	pce	POA
1152546	761069648	d25	25	55	20	112	89	47	6	1	pce	POA
1152547	761069649	d32	32	55	25	112	94	52	6	1	pce	POA
1152548	761069650	d40	40	90	32	165	112	65	2	1	pce	POA
1152549	761069651	d50	50	90	40	165	120	71	2	1	pce	POA
1152550	761069652	d63	63	90	50	165	141	90	2	1	pce	POA

GF Instaflex retrofit top

- Suitable to repair the old version of the INSTAFLEX system valve and the new BTV 2.
- For additional information see the installation manual for BTV 2 (760 809 086)
- Gasket: EPDM, quality for potable water
- Material: PB, Brass
- Operation pressure: 16 bars



Item No.	Item no. GF	Dimensions	L mm	W mm	H mm	W kg	Pallet/ Pack	Box/M QTY	UOM	Price per m/each
1152182	761066897	d32	40	40	109	0,227		1	pce	POA

GF Instaflex retrofit top

- Suitable to repair the old version of the INSTAFLEX system valve and the new BTV 2
- For additional information please see the installation manual for BTV 2 (760 809 086)



Item No.	Item no. GF	Dimensions	L mm	W mm	H mm	W kg	Pallet/ Pack	Box/M QTY	UOM	Price per m/each
1151938	761065303	d40-63	91	91	150.5	0,878		1	pce	POA

Instaflex

GF Instaflex ball valve 546 pro PP max. 70deg

- Compressed air 10 bar
- Working temperature max. +70°C
- * on request

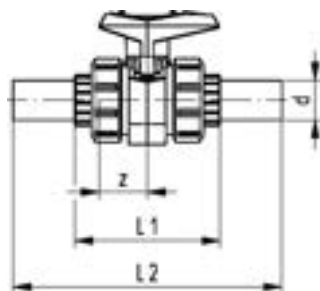

Item No.	Item no. GF	Dimensions	d mm	DN mm	L1 mm	L2 mm	PN bar	z mm	remarks	Pallet/Pack	Box/M QTY	UOM	Price per m/each
1151588	760000343	DN15	20	15	95	190	10	*	33	6	1	pce	POA
1151589	760000344	DN20	25	20	108	208	10	*	38		1	pce	POA
1151591	760000346	DN32	40	32	137	250	10	*	47	8	1	pce	POA
1151592	760000347	DN40	50	40	147	263	10	*	49		1	pce	POA
1151593	760000348	DN50	63	50	168	288	10	*	46		1	pce	POA

GF Instaflex ball valve 546 pro PP

- For portable water installations, not DVGW approved

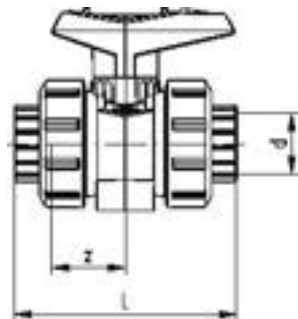

Item No.	Item no. GF	Dimensions	d mm	DN mm	L mm	PN bar	z mm	Pallet/Pack	Box/M QTY	UOM	Price per m/each
1151582	760000337	DN15	20	15	95	16	33	10	1	pce	POA
1151583	760000338	DN20	25	20	108	16	38	10	1	pce	POA
1151585	760000340	DN32	40	32	137	16	47	6	1	pce	POA
1151587	760000342	DN50	63	50	168	16	46	4	1	pce	POA

GF Instaflex flange adaptor flat

- Suitable to ball valve 546
- on request

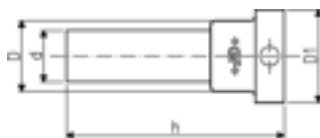

Item No.	Item no. GF	Dimensions	D1 mm	d mm	D mm	h mm	Pallet/Pack	Box/M QTY	UOM	Price per m/each
1152533	761069627	d20	34	20	27	66		1	pce	POA
1152534	761069628	d25	41	25	33	71		1	pce	POA
1152535	761069629	d32	50	32	41	74		1	pce	POA
1152536	761069630	d40	61	40	50	82		1	pce	POA
1152538	761069632	d63	90	63	76	94		1	pce	POA

Instaflex

GF Instaflex weld machine Electro Fusion G3

- Including welding cable for fittings without tool case, primary cable 110V, primary cable 230V
- Primary cable (3m) with Euro standard plug EU-Standard plug
- Technical data: voltage 110V and 230V variable, power output max. 1500W
- Technical specifications: frequency 47/65Hz, protection rate IP54, incl. power-supply cable 110V and 230V (3m)
- With EU-Standard plug
- * on request



Item No.	Item no. GF	Dimensions	L mm	W mm	H mm	W kg	Pallet/ Pack	Box/M QTY	UOM	Price per m/each
1152285	761069015	L300	300	150	330	11,5		1	pce	POA

GF Instaflex weld machine Electro Fusion G3

- Technical data: Voltage 230V, Power max 1400W, Frequency 50/60Hz, Protection class IP 54, Main connection (3m)
- With EU-Standard plug



Item No.	Item no. GF	Dimensions	L mm	W mm	H mm	W kg	Pallet/ Pack	Box/M QTY	UOM	Price per m/each
1152288	761069021	L344	344	164	358	4,142		1	pce	POA

GF Instaflex power cable 110V

- * on request



Item No.	Item no. GF	Dimensions	L mm	W mm	H mm	W kg	Pallet/ Pack	Box/M QTY	UOM	Price per m/each
1152283	761069012	110V	210	50	10	0,4		1	pce	POA

GF Instaflex power cable 230V

- * on request



Item No.	Item no. GF	Dimensions	L mm	W mm	H mm	W kg	Pallet/ Pack	Box/M QTY	UOM	Price per m/each
1152284	761069013	230V	130	80	80	0,38		1	pce	POA

GF Instaflex welding cable 230V

- Matches to HWSG-3 - 230V



Item No.	Item no. GF	Dimensions	L mm	W mm	H mm	W kg	Pallet/ Pack	Box/M QTY	UOM	Price per m/each
1152280	761069006	16-110	273	28	270	0,246		1	pce	POA

Instaflex

GF Instaflex welding cable PVC

- Matches to HWSG-3 - 230V



Item No.	Item no. GF	Dimensions	L mm	W mm	H mm	W kg	Pallet/ Pack	Box/M QTY	UOM	Price per m/each
1152279	761069001	16-110	262	41	247	0,255		1	pce	POA

GF Instaflex welding cable PVC

- Matches to HWSG-3 - 230V
- 2 pcs. with cable straight
- 1 pc. with cable angle
- * on request



Item No.	Item no. GF	Dimensions	L mm	W mm	H mm	W kg	Pallet/ Pack	Box/M QTY	UOM	Price per m/each
1152281	761069008	16-110 8m	300	72	254	1,753		1	pce	POA

GF Instaflex heating element CH

- Delivery: electronic temperature regulation, Voltage 230V, Power 800W, Instruction for the socket fusion jointing
- * only for CH / swiss plug



Item No.	Item no. GF	Dimensions	L mm	W mm	H mm	W kg	Pallet/ Pack	Box/M QTY	UOM	Price per m/each
1152170	761066804	16-63 L413	413	191	115	1,639		1	pce	POA

GF Instaflex heat bushes

- Heating bushes for INSTAFLEX socket fusion (in conjunction with the BTM 110 fusion machine)



Item No.	Item no. GF	Dimensions	L mm	W mm	H mm	W kg	Pallet/ Pack	Box/M QTY	UOM	Price per m/each
1152176	761066881	d75	100	100	55	1,108		1	pce	POA
1152177	761066882	d90	120	120	60	1,74		1	pce	POA
1152178	761066883	d110	140	140	75	2,45		1	pce	POA

GF Instaflex heating bushes

- Heating bushes for INSTAFLEX socket fusion (in conjunction with the BTM 110 fusion machine)



Item No.	Item no. GF	Dimensions	L mm	W mm	H mm	W kg	Pallet/ Pack	Box/M QTY	UOM	Price per m/each
1152157	761066756	16	28	31	82	0,189		1	pce	POA
1152158	761066757	20	79	39	39	0,284		1	pce	POA
1152159	761066758	25	87	59	82	0,366		1	pce	POA
1152160	761066759	32	85	41	44	0,369		1	pce	POA
1152161	761066760	40	61	61	51	0,321		1	pce	POA
1152162	761066761	50	79	84	119	0,46		1	pce	POA
1152163	761066762	63	79	82	89	0,609		1	pce	POA

Instaflex

GF Instaflex heating bushes

- d = Pipe dim.

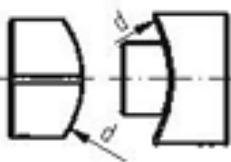

Item No.	Item no. GF	Dimensions	L mm	W mm	H mm	W kg	Pallet/ Pack	Box/M QTY	UOM	Price per m/each
1152252	761068027	40-20 32	46	38	39	0,129		1	pce	POA
1152253	761068028	50-20 32	52	39	41	0,156		1	pce	POA
1152255	761068030	75-20 32	56	44	44	0,216		1	pce	POA
1152256	761068031	90-20 32	50	40	40	0,272		1	pce	POA
1152257	761068032	110-20 32	50	40	40	0,298		1	pce	POA

GF Instaflex heating bushes

- For heating element straight
- d = Pipe dim.

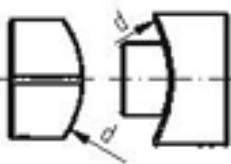

Item No.	Item no. GF	Dimensions	L mm	W mm	H mm	W kg	Pallet/ Pack	Box/M QTY	UOM	Price per m/each
1152258	761068033	125-32	64	54	54	0,376		1	pce	POA
1152259	761068034	125-40	67	64	65	0,51		1	pce	POA

GF Instaflex drilling cutler

- For weld-on saddle PB



Item No.	Item no. GF	Dimensions	L mm	W mm	H mm	W kg	Pallet/ Pack	Box/M QTY	UOM	Price per m/each
1152264	761068039	20-32	69	31	31	0,132		1	pce	POA
1152265	761068040	40-50	39	39	98	0,232		1	pce	POA

GF Instaflex heating element CH

- Description: Instaflex socket-fusion connection set
- Metal case
- Heating element with electronic temperature regulation Voltage 230V, Power 800W
- Heating bushes d16-d63
- Tempil sticks 253°C and 274°C, Timer, Template, Gloves, Support, Grip, Pipe shears, Pipe cutter d32-d63, Chamfering tool



Item No.	Item no. GF	Dimensions	L mm	W mm	H mm	W kg	Pallet/ Pack	Box/M QTY	UOM	Price per m/each
1152169	761066802	16-63 set	474	364	158	11,679		1	pce	POA

Instaflex

GF Instaflex cutting machine CMB225

- Description: Cutting machine for polyolefin pipes d110-d230.
- Cutting machine CMB 225 (1 pcs.)
- Machine cutting wheel CW 225 (3 pcs.)
- Pipe brackets PS 225 (4 pcs.)
- Wrench for cutter-change (1 pcs.)



Item No.	Item no. GF	In/Out	Dimensions	L mm	W mm	H mm	W kg	Pallet/ Pack	Box/M QTY	UOM	Price per m/each
1152710	761070319	11.25	225/220	225	526	271	241	38	1	pce	POA

GF Instaflex cutting insert

- *as long as stock last



Item No.	Item no. GF	In/Out	Dimensions	L mm	W mm	H mm	W kg	Pallet/ Pack	Box/M QTY	UOM	Price per m/each
1152713	761070323	11.25	50-100	270	140	60	2		1	pce	POA

GF Instaflex machines cutter CW225

- Replacement cutting wheel for cutting machine CMB 225



Item No.	Item no. GF	In/Out	Dimensions	L mm	W mm	H mm	W kg	Pallet/ Pack	Box/M QTY	UOM	Price per m/each
1152711	761070320	11.25	225 225	125	125	10	0,24		1	pce	POA

GF Instaflex ball-head wrench

- With cross handle



Item No.	Item no. GF	Dimensions	L mm	W mm	H mm	W kg	Pallet/ Pack	Box/M QTY	UOM	Price per m/each
1152171	761066843	16-63	180	80	20	0,038		2	pce	POA
1152172	761066844	75-110	180	80	20	0,038		2	pce	POA

GF Instaflex gloves

- Protective glove for high protection under moderate heat conditions



Item No.	Item no. GF	L mm	W mm	H mm	W kg	Pallet/ Pack	Box/M QTY	UOM	Price per m/each
1152166	761066799	300	200	20	0,115		1	pce	POA

Instaflex

GF Instaflex coupler Electro Fusion

- PN 16 at 20°C



Item No.	Item no. GF	Dimensions	d mm	L mm	Pallet/ Pack	Box/M QTY	UOM	Price per m/each
1152503	761069555	d125	125	186	5	1	pce	POA
1152504	761069556	d160	160	190	4	1	pce	POA
1152505	761069557	d225	225	220	2	1	pce	POA

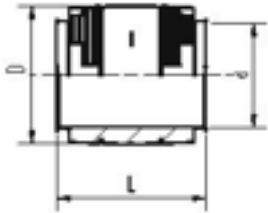

GF Instaflex saddle adapter MT

- Weld-in saddle transition to male thread
- Thread in DZR brass, UBA listed
- EPDM sealing hot and cold water

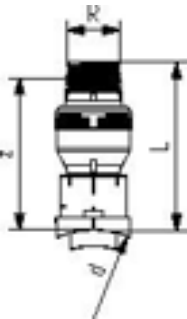

Item No.	Item no. GF	Dimensions	d mm	L mm	R inch	z mm	Pallet/ Pack	Box/M QTY	UOM	Price per m/each
1152655	761069758	50-25 3/4"	50	100	3/4	75	2	2	pce	POA
1152656	761069759	63-32 1"	63	100	1	83	2	2	pce	POA
1152657	761069760	75-32 1"	75	100	1	83	2	2	pce	POA
1152658	761069761	90-32 1"	90	103	1	86	2	2	pce	POA
1152659	761069762	110-32 1"	110	105	1	88	2	2	pce	POA
1152660	761069763	125-32 1"	125	108	1	91	2	2	pce	POA
1152661	761069764	160-32 1"	160	108	1	91	2	2	pce	POA
1152662	761069765	225-32 1"	225	108	1	91	2	2	pce	POA

GF Instaflex reduction PN10

- Material: Polybutene



Item No.	Item no. GF	Dimensions	d1 mm	d2 mm	L1 mm	L2 mm	z mm	Pallet/ Pack	Box/M QTY	UOM	Price per m/each
1151917	761065267	125-110	125	110	92	85	215	8	1	pce	POA
1151918	761065268	160-125	160	125	102	92	245	8	1	pce	POA

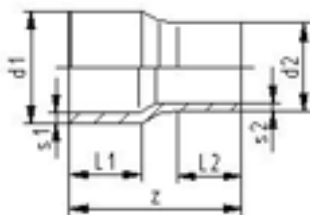

Instaflex

GF Instaflex flange adapter PB PN10

- Material: Polybutene

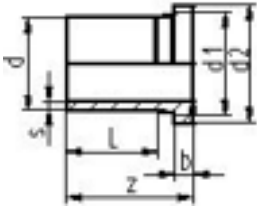

Item No.	Item no. GF	Dimensions	b mm	d1 mm	d2 mm	d mm	L mm	z mm	Pallet/ Pack	Box/M QTY	UOM	Price per m/each
1151915	761065265	d160	25	176	218	160	147	200	6	1	pce	POA

GF Instaflex flange adapter flat

- Material: Polybutene

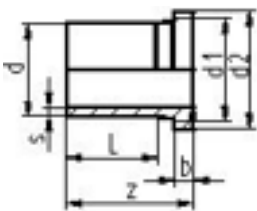

Item No.	Item no. GF	Dimensions	b mm	d1 mm	d2 mm	d mm	L mm	z mm	Pallet/ Pack	Box/M QTY	UOM	Price per m/each
1151914	761065264	d125	25	132	162	125	123	170	16	1	pce	POA

GF Instaflex flange

- Material: Casting, GFK coated
- Suitable for flange adaptor
- Tighten the screws with torque as indicated
- Requires standard screws, nuts, washers

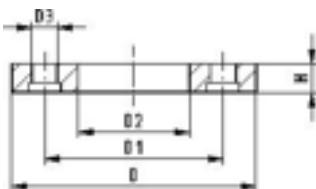

Item No.	Item no. GF	Dimensions	L mm	W mm	H mm	W kg	Pallet/ Pack	Box/M QTY	UOM	Price per m/each
1151929	761065279	d125	226	224	23	1,284		2	pce	POA

Instaflex

GF Instaflex pipe ties

- Material: plastic
- For iFIT, INSTAFLEX, JRG Sanipex, JRG Sanipex MT



Item No.	Item no. GF	Dimensions	d-d mm	L mm	Pallet/ Pack	Box/M QTY	UOM	Price per m/each
1151707	760854984	90-110 430	90	110 430		100	pce	POA

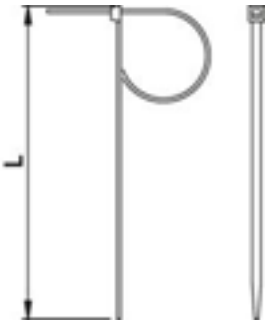

GF Instaflex pipe clamp

- For iFIT, INSTAFLEX, JRG Sanipex, JRG Sanipex MT

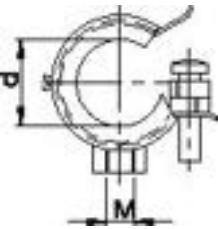

Item No.	Item no. GF	Dimensions	d mm	M mm	Pallet/ Pack	Box/M QTY	UOM	Price per m/each
1152012	761066296	d16	16	8		50	pce	POA
1152013	761066297	d20	20	8		50	pce	POA
1152014	761066298	d25	25	8		50	pce	POA
1152015	761066299	d32	32	8		50	pce	POA
1152016	761066300	d40	40	8		50	pce	POA
1152017	761066301	d50	50	8		50	pce	POA
1152018	761066302	d63	63	8		50	pce	POA
1152019	761066303	d75	75	8		50	pce	POA
1152020	761066304	d90	90	10		25	pce	POA
1152021	761066305	d110	110	10		25	pce	POA

Instaflex

GF Instaflex MSA 2 Multi

- The MSA 2 MULTI automatic electric welding machine combines low weight with high performance thanks to inverter technology.
- The device is suitable for welding PE,
- PP, INSTAFLEX PB d125-225, Fuseal d1 1/2"-12" and PPro-Seal 1/2"-3".
- It is robust, safe, and ergonomic.
- Designed to simplify work steps on the construction site: barcode scanner with
- long-distance scanning functionality, active cooling system for safe serial welding, use of symbols for intuitive dialogue between user and machine.
- The entire welding process is monitored and controlled. The output energy is adjusted according to the ambient temperature and the calculated cooling time.
- The MSA 2 MULTI has a storage capacity of up to 500 logs. The user can transfer the
- logs from the device to a USB stick in PDF format.
- Scope of delivery: 1 pair of 4.0 mm angle adapter plugs, operating instructions and START/STOP card, USB stick and a sturdy carrying case.
- Technical data:
 - Temperature range: -20°C to +50°C
 - Voltage and frequency range: 230V (190V - 265V), 50-60Hz
 - Welding data input: Barcode, manual
 - Fittings dimension range: d16-630 mm, 1/2"-12"
 - Welding voltage: 3.6 - 40V
 - Welding current: 90 A (max)
 - Recommended generator power: 3.5 kVA
 - USB interfaces: Type A
 - Protection class: Class 1 / IP 65
 - Power cable: 4 m / Welding cable: 3 m
 - Weight: approx. 11.9 kg
 - Display: Graphic LCD, adjustable



Item No.	Item no. GF	L mm	W mm	H mm	W kg	Pallet/ Pack	Box/M QTY	UOM	Price per m/each
1163309	790156022	280	280	420	11,9		1	pce	POA

GF Instaflex tangit KS cleaner

- Excellent cleaning properties
- Prevents leakage problems
- High quality
- Leak-proof and tamper-proof bottle
- Approved for drinking water applications



Item No.	Item no. GF	L mm	W mm	H mm	W kg	Pallet/ Pack	Box/M QTY	UOM	Price per m/each
1162761	799298023	26	8	8	1,1	8	1	pce	POA

Aquasystem



Benefits

- Noise reduction
- Corrosion free
- Easy jointing technology
- Less maintenance cost

AQUASYSTEM (PP-R and PP-RCT) is a perfect solution for hot and cold water applications within residential and commercial buildings as well as healthcare facilities and marine applications.

Specification

- AQUASYSTEM is one of the most reliable and high-quality PP-R systems on the market. It is ideal for transporting both hot and cold water in a variety of building systems as well as industrial and marine applications. The system features high temperature and pressure resistance while being hygienically safe and eligible for use in drinking water supply systems. Thanks to its chemical resistance behavior, the system is also a great choice for transferring or discharging chemical media.

Application

- Central heating systems
- Hot and cold water systems
- Drinking water and treated water supply systems
- Industrial Piping Systems (Transfer and discharge of chemicals)
- Air conditioner systems
- Solar Collectors

Certification

- WRAS Material approval (BS6920)

GF Aquasystem pipe green fiberglass PPR green PN20/SDR7.4

- PP-R Green material
- PN20

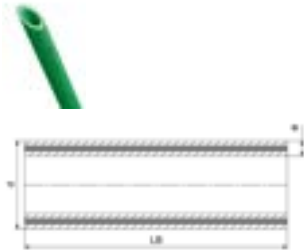

Item No.	Item no. GF	Dimensions	e mm	Pallet/ Pack	Box/M QTY	UOM	Price per m/each
1148032	4202003200421	32mm	4,4	2100	4	m	POA

Aquasystem

GF Aquasystem Socket PPR green

- Material: PPR
- Colour: Green

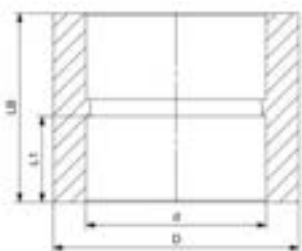

Item No.	Item no. GF	Dimensions	L mm	W mm	H mm	W kg	Pallet/ Pack	Box/M QTY	UOM	Price per m/each
1148697	4302502020021	20mm	28	28	33	0,01	500	100	pce	POA
1148698	4302502520121	25mm	33	33	37	0,017	350	50	pce	POA
1148699	4302503220221	32mm	41	41	40	0,024	200	40	pce	POA
1148700	4302504020321	40mm	45	52	52	0,042	125	25	pce	POA
1148701	4302505020421	50mm	66	66	52	0,078	70	10	pce	POA
1148702	4302506320521	63mm	84	84	58	0,14	45	9	pce	POA
1148703	4302507520621	75mm	100	100	66	0,213	30	5	pce	POA
1148704	4302509020721	90mm	120	120	75	0,35	20	4	pce	POA
1148705	4302511020821	110mm	145	145	85	0,57	10	1	pce	POA

GF Aquasystem Crossover With Socket PPR green

- PP-R Green material



Item No.	Item no. GF	Dimensions	L mm	W mm	H mm	W kg	Pallet/ Pack	Box/M QTY	UOM	Price per m/each
1148827	4302902000121	20mm	30	162	48	0,041	120	30	pce	POA
1148858	4302902500221	25mm	37	206	60	0,071	80	16	pce	POA
1148882	4302903200321	32mm	45	250	80	0,156	30	5	pce	POA

GF Aquasystem Transition Socket male thread PPR green

- PP-R Green material

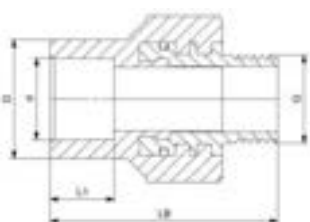

Item No.	Item no. GF	Dimensions	L mm	W mm	H mm	W kg	Pallet/ Pack	Box/M QTY	UOM	Price per m/each
1148723	4302702040921	20-1/2" R	40	40	55	0,071	250	50	pce	POA
1148740	4302702540921	25-1/2" R	40	40	55	0,072	200	40	pce	POA
1148760	4302703240121	32 3/4"	53	53	61	0,094	100	20	pce	POA
1148722	4302702040321	20-3/4"	42	42	57	0,069	200	25	pce	POA
1148739	4302702540321	25-3/4"	41	41	52	0,067	200	40	pce	POA
1148762	4302703240321	32-1"	53	53	61	0,118	100	20	pce	POA

Aquasystem

GF Aquasystem Transition Socket female thread PPR green

- PP-R Green material



Item No.	Item no. GF	Dimensions	L mm	W mm	H mm	W kg	Pallet/ Pack	Box/M QTY	UOM	Price per m/each
1148720	4302702040021	20-1/2"	40	40	40	0,054	325	25	pce	POA
1148721	4302702040121	20-3/4"	45	45	45	0,054	250	25	pce	POA
1148737	4302702540021	25-1/2"	40	40	40	0,049	225	25	pce	POA
1148738	4302702540121	25-3/4"	40	40	40	0,054	225	25	pce	POA
1148761	4302703240221	32-1"	53	53	46	0,091	125	25	pce	POA
1148759	4302703240021	32-3/4"	53	53	46	0,082	100	20	pce	POA

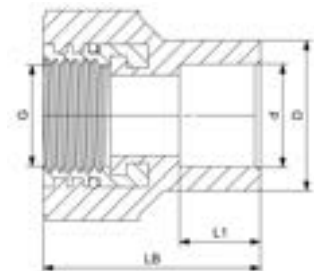

GF Aquasystem Transition hexagonal male thread PPR green

- PP-R Green material



Item No.	Item no. GF	Dimensions	L mm	W mm	H mm	W kg	Pallet/ Pack	Box/M QTY	UOM	Price per m/each
1148791	4302709029621	90-3"	140	140	125	1,4345	10	1	pce	POA

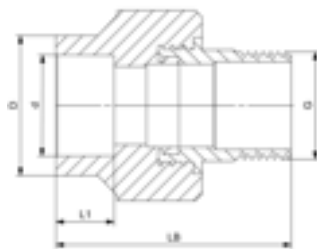

GF Aquasystem Transition Socket hexagonal female thread PPR Green

- PP-R Green material



Item No.	Item no. GF	In/Out	Dimensions	L mm	W mm	H mm	W kg	Pallet/ Pack	Box/M QTY	UOM	Price per m/each
1148756	4302703230621	12.26	32-1"	60	60	60	0,186	80	20	pce	POA
1148767	4302704040021		40-1 1/4"	70	70	60	0,278	50	10	pce	POA
1148773	4302705040021		50-1 1/2"	77	77	65	0,26	40	5	pce	POA
1148779	4302706340021		63-2"	105	105	80	0,438	20	5	pce	POA
1148782	4302707525621		75mm 2 1/2"	120	120	80	0,9978	16	4	pce	POA
1148794	4302711025721		110mm 4"	165	165	105	1,6773	6	1	pce	POA
1148788	4302709028621		90mm	140	140	100	1,3965	10	1	pce	POA

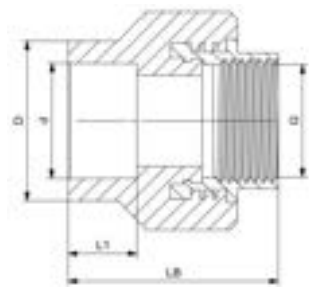

Aquasystem

GF Aquasystem Transition Socket hexagonal male thread PPR Green

- PP-R Green material

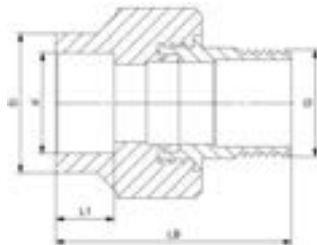

Item No.	Item no. GF	In/Out	Dimensions	L mm	W mm	H mm	W kg	Pallet/ Pack	Box/M QTY	UOM	Price per m/each
1148753	4302703230321	12.26	32-1"	60	60	75	0,18	80	20	pce	POA
1148768	4302704040121		40-1 1/4"	70	70	80	0,279	50	10	pce	POA
1148774	4302705040121		50-1 1/2"	77	77	82	0,37	40	5	pce	POA
1148780	4302706340121		63-2"	105	105	100	0,662	20	5	pce	POA
1148785	4302707527621		75mm 2 1/2"	120	120	105	1,1	16	4	pce	POA
1148797	4302711027821		110mm 4"	165	165	130	2,12	4	1	pce	POA

GF Aquasystem Elbow PPR green 45°

- Material: PPR
- Colour: Green

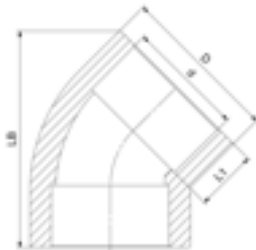

Item No.	Item no. GF	Dimensions	l1 mm	l mm	do mm	d mm	Pallet/ Pack	Box/M QTY	UOM	Price per m/each	
1148606	4302102000121	20mm		28	38	45	0,015	400	50	pce	POA
1148620	4302102500221	25mm		33	45	52	0,02	300	50	pce	POA
1148640	4302103200321	32mm		43	55	60	0,035	175	25	pce	POA

Aquasystem

GF Aquasystem Elbow PPR green 90°

- Material: PPR
- Colour: Green

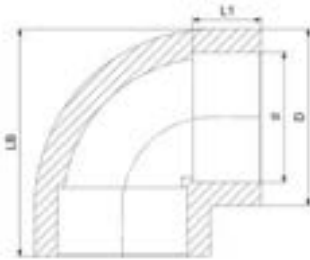

Item No.	Item no. GF	Dimensions	l1	l	do	d	Pallet/ Pack	Box/M QTY	UOM	Price per m/
1148607	4302102000721	20mm				28 40 40	0,016 400	50	pce	POA
1148621	4302102500821	25mm				33 47 47	0,022 250	50	pce	POA
1148641	4302103200921	32mm				43 56 56	0,039 125	25	pce	POA
1148651	4302104000421	40mm				53 56 70	0,063 75	15	pce	POA
1148652	4302104001021	40mm				53 68 68	0,075 75	15	pce	POA
1148653	4302105000521	50mm				66 82 86	0,119 40	5	pce	POA
1148654	4302105001121	50mm				66 85 85	0,15 40	5	pce	POA
1148655	4302106300621	63mm				84 102 103	0,232 20	4	pce	POA
1148656	4302106301221	63mm				84 103 103	0,282 20	4	pce	POA
1148657	4302107501221	75mm				99 119 120	0,343 16	4	pce	POA
1148658	4302107501321	75mm				99 120 120	0,43 16	4	pce	POA
1148659	4302109001421	90mm				120 142 142	0,72 8	1	pce	POA
1148661	4302111001521	110mm				145 170 170	1,3 3	1	pce	POA

GF Aquasystem Reducing Elbow PPR green 90°

- PP-R Green material
- Elbow

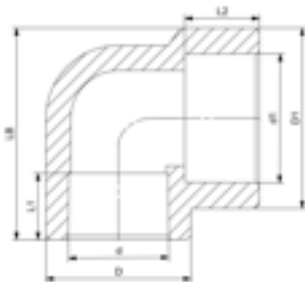

Item No.	Item no. GF	Dimensions	di	l2	Pallet/ Pack	Box/M QTY	UOM	Price per m/each
1148668	4302402511121	25-32mm	31,1	18,0	150	25	pce	POA

Aquasystem

GF Aquasystem Elbow Male/Female PPR green 90°

- PP-R Green material



Item No.	Item no. GF	Dimensions	di mm	l2 mm	Pallet/ Pack	Box/M QTY	UOM	Price per m/each
1148608	4302102005021	20mm	20	16,0	350	50	pce	POA
1148622	4302102505121	25mm	25	17,0	200	40	pce	POA

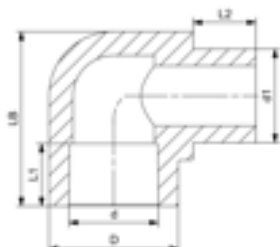

GF Aquasystem female elbow PPR green 90°

- PP-R Green material



Item No.	Item no. GF	Dimensions	L mm	W mm	H mm	W kg	Pallet/ Pack	Box/M QTY	UOM	Price per m/each
1148615	4302102030021	20-1/2"FT	44	36	48	0,046	200	50	pce	POA
1148616	4302102030121	20-3/4"FT	52	40	50	0,0674	200	40	pce	POA
1148633	4302102530021	25-1/2"FT	51	38	52	0,061	175	25	pce	POA
1148634	4302102530121	25-3/4"FT	34	42	59	0,073	140	35	pce	POA
1148648	4302103230121	32-1"FT	59	53	63	0,125	75	15	pce	POA
1148647	4302103230021	32-3/4"FT	59	53	63	0,11	75	15	pce	POA

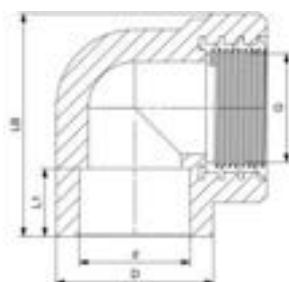

GF Aquasystem Elbow with male thread PPR green 90°

- PP-R Green material



Item No.	Item no. GF	Dimensions	L mm	W mm	H mm	W kg	Pallet/ Pack	Box/M QTY	UOM	Price per m/each
1148617	4302102030221	20-1/2"MT	57	36	48	0,061	200	40	pce	POA
1148618	4302102030321	20-3/4"MT	66	40	50	0,085	180	20	pce	POA
1148635	4302102530221	25-1/2"MT	65	52	38	0,075	180	30	pce	POA
1148636	4302102530321	25-3/4"MT	67	59	42	0,091	100	25	pce	POA
1148650	4302103230321	32-1"MT	74	53	63	0,1395	80	10	pce	POA
1148649	4302103230221	32-3/4"MT	73	53	63	0,122	75	15	pce	POA

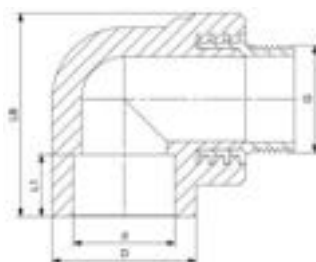

Aquasystem

GF Aquasystem Backplate Elbow female 2 screw hole PPR green 90°

- PP-R Green material



Item No.	Item no. GF	Dimensions	Rp inch	l mm	d mm	Pallet/ Pack	Box/M QTY	UOM	Price per m/each	
1148854	4302902030721	20-1/2"FT		54	66 60	0,0657	150	25	pce	POA

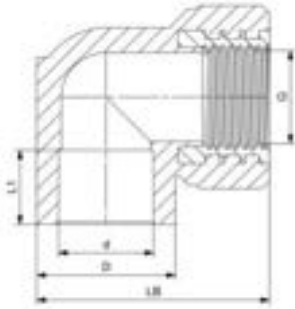

GF Aquasystem Backplate Elbow female 3 screw hole PPR green 90°

- PP-R Green material



Item No.	Item no. GF	Dimensions	L mm	W mm	H mm	W kg	Pallet/ Pack	Box/M QTY	UOM	Price per m/each
1148637	4302102530421	25mm 1/2"FT	54	66	60	0,0771	100	20	pce	POA
1148619	4302102030421	20-3/4"	54	66	60	0,0691	100	20	pce	POA
1148638	4302102530521	25-3/4"	54	66	60	0,082	100	20	pce	POA

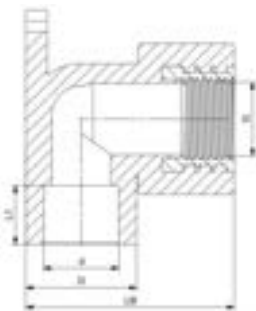

GF Aquasystem Backplate Elbow male 2 screw hole PPR green 90°

- PP-R Green material



Item No.	Item no. GF	Dimensions	L mm	W mm	H mm	W kg	Pallet/ Pack	Box/M QTY	UOM	Price per m/each
1148853	4302902030621	20-1/2"MT	60	60	45	0,0766	150	25	pce	POA

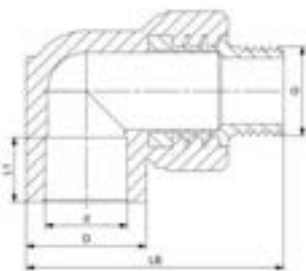

Aquasystem

GF Aquasystem Backplate Elbow male 3 screw hole PPR green 90°

- PP-R Green material



Item No.	Item no. GF	Dimensions	L mm	W mm	H mm	W kg	Pallet/ Pack	Box/M QTY	UOM	Price per m/each
1148639	4302102530621	25mm 3/4"MT	66	66	60	0,0966	100	25	pce	POA

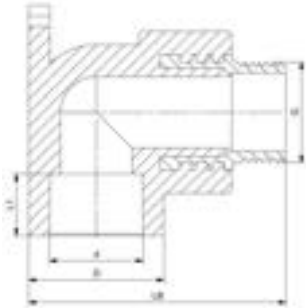

GF Aquasystem Tee PPR green

- Two alternatives for d160 mm fittings: Butt fusion and Socket fusion fittings.
- Butt fusion product is SDR 11 and only compatible with same SDR pipes.
- Socket fusion product could be welded with all type of pipes.



Item No.	Item no. GF	Dimensions	L mm	W mm	H mm	W kg	Pallet/ Pack	Box/M QTY	UOM	Price per m/each
1148835	4302902008021	20mm	52	38	40	0,022	250	50	pce	POA
1148866	4302902508121	25mm	59	33	56	0,03	150	25	pce	POA
1148885	4302903208221	32mm	70	41	56	0,053	100	10	pce	POA
1148906	4302904008321	40mm	87	55	70	0,115	50	5	pce	POA
1148920	4302905008421	50mm	103	66	84	0,176	30	5	pce	POA
1148937	4302906308521	63mm	128	83	105	0,34	20	4	pce	POA
1148950	4302907508621	75mm	140	100	120	0,54	10	1	pce	POA
1148963	4302909008721	90mm	165	120	140	0,86	6	1	pce	POA
1148971	4302911008821	110mm	195	145	170	1,565	3	1	pce	POA

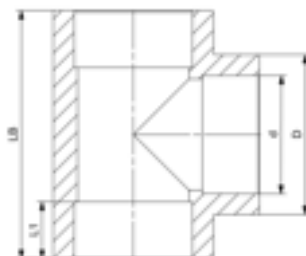

Aquasystem

GF Aquasystem Reducing Tee PPR green

- Material: PPR
- Colour: Green

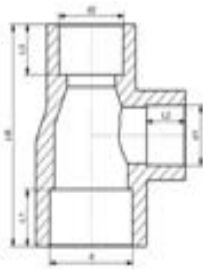

Item No.	Item no. GF	In/Out	Dimensions	di mm	l1 mm	l2 mm	l3 mm	l mm	d mm	d1 mm	d2 mm	Pallet/ Pack	Box/M QTY	UOM	Price per m/
1148872	4302902520021		25x20x20mm	19,2	14,5	14,5					19,2	200	25	pce	POA
1148873	4302902520121		25x20x25mm	19,2	14,5							175	25	pce	POA
1148889	4302903220221		32x20x20mm	19,2	14,5	14,5					19,2	125	25	pce	POA
1148890	4302903220321		32x20x25mm	19,2	14,5	16,0					24,2	125	25	pce	POA
1148891	4302903220421		32x20x32mm	19,2	17,2							100	10	pce	POA
1148892	4302903220521		32x25x20mm	24,2	16,0	14,5					19,2	125	25	pce	POA
1148893	4302903220621		32x25x32mm	24,2	17,5							100	10	pce	POA
1148907	4302904020721		40x20x40mm	19,2	17,4							50	5	pce	POA
1148908	4302904020821		40x25x40mm	24,3	17,4							50	5	pce	POA
1148909	4302904020921		40x32x40mm	31,1	20,0							50	5	pce	POA
1148922	4302905021021		50x20x50mm	19,2	18,0							40	5	pce	POA
1148923	4302905021221		50x25x50mm	24,4	17,0							30	5	pce	POA
1148924	4302905021321		50x32x50mm	31,1	20,5							30	5	pce	POA
1148925	4302905021421		50x40x50mm	39,0	20,5							30	5	pce	POA
1148687	4302409021622		90x63x90mm	61,9	27,5							576	12	pce	POA
1148691	4302411021522		110x63x110mm	61,9	27,5							144	3	pce	POA
1148693	4302412521622	12.26	125x75x125mm	73,4	30,0							96	2	pce	POA
1148694	4302412521722	12.26	125x90x125mm	88,2	33,0							96	2	pce	POA

Aquasystem

GF Aquasystem Reducing Tee PPR green

- PP-R Green material
- Reducing Tee

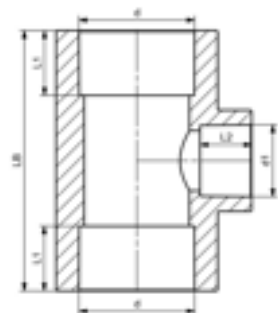

Item No.	Item no. GF	Dimensions	di mm	l2 mm	Pallet/ Pack	Box/M QTY	UOM	Price per m/each
1148938	4302906321321	63x20x63mm	19,2	14,5	24	4	pce	POA
1148939	4302906321421	63x25x63mm	24,3	16,5	24	4	pce	POA
1148940	4302906321521	63x32x63mm	31,5	18,1	24	4	pce	POA
1148941	4302906321621	63x40x63mm	39,4	21,1	16	4	pce	POA
1148942	4302906321721	63x50x63mm	48,9	23,5	16	4	pce	POA
1148952	4302907521721	75x25x75mm	24,2	16,0	10	2	pce	POA
1148953	4302907521821	75x32x75mm	31,1	18,0	10	2	pce	POA
1148954	4302907521921	75x40x75mm	39,0	20,5	10	2	pce	POA
1148955	4302907522021	75x50x75mm	48,9	23,5	10	2	pce	POA
1148956	4302907522121	75x63x75mm	61,9	27,5	10	2	pce	POA
1148973	4302911021622	110x75x110mm	73,4	31,3	3	1	pce	POA

GF Aquasystem Cross PPR green

- PP-R Green material

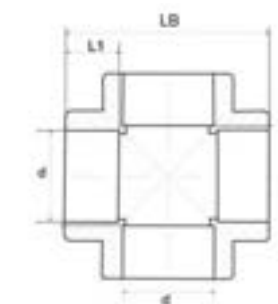

Item No.	Item no. GF	In/Out	Dimensions	L mm	W mm	H mm	W kg	Pallet/ Pack	Box/M QTY	UOM	Price per m/each
1148856	4302902060022		20mm	25	50	50	0,024	200	50	pce	POA
1148880	4302902560122		25mm	32	55	55	0,037	150	25	pce	POA
1148900	4302903260222		32mm	40	60	60	0,062	75	15	pce	POA
1148915	4302904060322	12.26	40mm	50	90	90	0,103	40	10	pce	POA

GF Aquasystem Transition Tee PPR green

- PP-R Green material

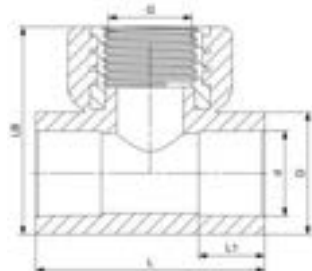

Item No.	Item no. GF	Dimensions	l mm	Pallet/ Pack	Box/M QTY	UOM	Price per m/each
1148848	4302902030021	20-1/2"FT	51,5	160	20	pce	POA
1148850	4302902030221	20-1/2"MT	51,5	150	30	pce	POA
1148849	4302902030121	20-3/4"FT	59,0	160	20	pce	POA
1148877	4302902530021	25-1/2"FT	59,0	120	15	pce	POA
1148878	4302902530121	25-3/4"FT	59,0	120	20	pce	POA
1148898	4302903230121	32-1"FT	74,5	70	10	pce	POA
1148897	4302903230021	32-3/4"FT	75,0	60	15	pce	POA

Aquasystem

GF Aquasystem Transition with loose nut PPR green

- PP-R Green material



Item No.	Item no. GF	Dimensions	L mm	W mm	H mm	W kg	Pallet/ Pack	Box/M QTY	UOM	Price per m/each
1148843	4302902013021	1/2" 20	30	30	70	0,077	300	50	pce	POA
1148869	4302902513221	3/4" 25	35	35	75	0,108	200	50	pce	POA
1148870	4302902513321	1"-25	45	45	75	0,159	150	25	pce	POA

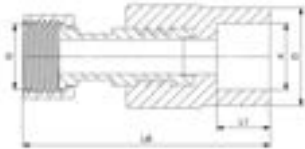

GF Aquasystem Transition Joint hexagonal male PPR green

- PP-R Green material



Item No.	Item no. GF	Dimensions	L mm	W mm	H mm	W kg	Pallet/ Pack	Box/M QTY	UOM	Price per m/each
1148716	4302702030521	20-1/2"	36	36	55	0,105	300	50	pce	POA
1148752	4302703230121	32-1"	55	55	66	0,23	125	25	pce	POA
1148852	4302902030421	20-3/4"	36	36	55	0,179	150	50	pce	POA

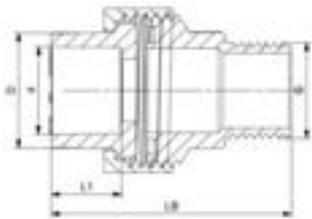

GF Aquasystem Transition Joint hexagonal female thread PPR green

- PP-R Green material



Item No.	Item no. GF	In/Out	Dimensions	L mm	W mm	H mm	W kg	Pallet/ Pack	Box/M QTY	UOM	Price per m/each
1148851	4302902030321		20-3/4"	36	36	40	0,158	150	50	pce	POA
1148751	4302703230021	OUT	32-1"	55	55	50	0,125	150	25	pce	POA
1148912	4302904030021	OUT	40mm 1 1/4"	65	65	40	0,317	50	10	pce	POA

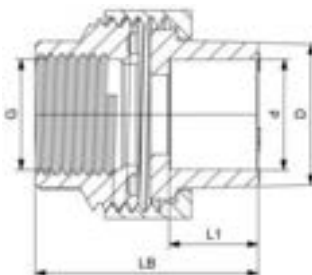

Aquasystem

GF Aquasystem Transition Joint hexagonal female thread PPR green

- PP-R Green material

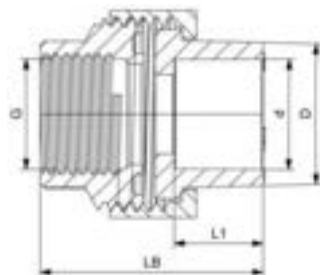

Item No.	Item no. GF	In/Out	Dimensions	L mm	W mm	H mm	W kg	Pallet/ Pack	Box/M QTY	UOM	Price per m/each
1148715	4302702030421		20-1/2"	36	36	40	0,07	300	50	pce	POA
1148728	4302702530021	OUT	25-3/4"	45	45	45	0,106	150	50	pce	POA
1148928	4302905030021	OUT	50mm 1 1/2"	80	80	60	0,567	30	5	pce	POA
1148944	4302906330021		63mm 2"	100	100	65	0,807	20	2	pce	POA

GF Aquasystem Transition Joint hexagonal male PPR green

- PP-R Green material

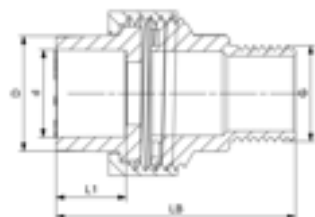

Item No.	Item no. GF	Dimensions	L mm	W mm	H mm	W kg	Pallet/ Pack	Box/M QTY	UOM	Price per m/each
1148913	4302904030121	40mm 1 1/4"	65	65	77	0,395	50	10	pce	POA
1148929	4302905030121	50mm 1 1/2"	80	80	80	0,601	30	5	pce	POA
1148945	4302906330121	63mm 2" R	100	100	83	0,887	20	2	pce	POA
1148729	4302702530121	25-3/4"	45	45	60	0,18	150	30	pce	POA

Aquasystem

GF Aquasystem Reducer PPR green

- Material: PPR
- Colour: Green

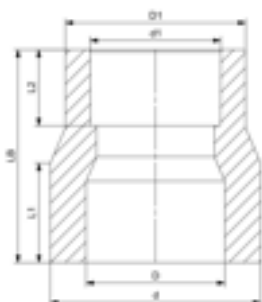

Item No.	Item no. GF	Dimensions	di mm	l2 mm	Pallet/ Pack	Box/M QTY	UOM	Price per m/each
1148667	4302402510021	25-20mm	19,2	15,5	500	100	pce	POA
1148669	4302403210121	32-20mm	19,2	14,5	400	50	pce	POA
1148670	4302403210221	32-25mm	24,2	16,0	350	50	pce	POA
1148671	4302404010321	40-20mm	19,2	16,0	250	50	pce	POA
1148672	4302404010421	40-25mm	24,2	19,0	250	25	pce	POA
1148673	4302404010521	40-32mm	31,1	20,0	175	25	pce	POA
1148674	4302405010621	50-20mm	19,2	14,5	150	25	pce	POA
1148675	4302405010721	50-25mm	24,2	16,0	150	25	pce	POA
1148676	4302405010821	50-32mm	31,1	18,1	150	25	pce	POA
1148677	4302405010921	50-40mm	39,0	20,5	100	20	pce	POA
1148678	4302406311021	63-25mm	24,2	16,5	75	15	pce	POA
1148679	4302406311121	63-32mm	31,1	18,1	75	15	pce	POA
1148680	4302406311221	63-40mm	39,0	20,7	75	15	pce	POA
1148681	4302406311321	63-50mm	48,9	32,2	50	10	pce	POA
1148682	4302407511421	75-50mm	48,9	24,0	40	8	pce	POA
1148683	4302407511521	75-63mm	61,9	28,0	40	8	pce	POA
1148684	4302409011521	90-50mm	48,9	23,5	20	5	pce	POA
1148685	4302409011621	90-63mm	61,9	27,5	20	5	pce	POA
1148686	4302409011721	90-75mm	73,4	30,5	16	4	pce	POA
1148688	4302411011721	110-63mm	61,9	28,0	16	4	pce	POA
1148689	4302411011821	110-75mm	73,4	31,0	16	4	pce	POA
1148690	4302411011921	110-90mm	89,0	35,5	16	4	pce	POA
1148696	4302416012322	160x125mm	102,2	95,0	3	1	pce	POA

GF Aquasystem end cap PPR green

- PP-R Green material

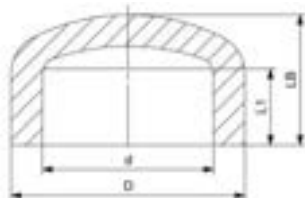

Item No.	Item no. GF	Dimensions	L mm	W mm	H mm	W kg	Pallet/ Pack	Box/M QTY	UOM	Price per m/each
1148833	4302902006021	20mm	28	28	23	0,009	1000	100	pce	POA
1148864	4302902506121	25mm	34	34	27	0,012	600	100	pce	POA
1148883	4302903206221	32mm	42	42	30	0,021	300	50	pce	POA
1148904	4302904006321	40mm	52	52	39	0,038	175	25	pce	POA
1148919	4302905006421	50mm	65	65	46	0,065	100	10	pce	POA
1148936	4302906306521	63mm	83	83	45	0,13	50	10	pce	POA
1148949	4302907506621	75mm	100	100	51	0,199	25	5	pce	POA
1148962	4302909006821	90mm	120	120	60	0,344	18	3	pce	POA
1148970	4302911006721	110mm	145	145	70	0,608	9	3	pce	POA

Aquasystem

GF Aquasystem Blind Cap PPR green

- PP-R Green material

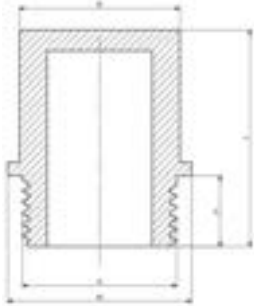

Item No.	Item no. GF	Dimensions	G inch	l1 mm	l2 mm	l mm	do mm	Pallet/ Pack	Box/M QTY	UOM	Price per m/each
1148844	4302902014021	20mm	1/2	12	25	31	29	700	100	pce	POA
1148871	4302902514121	25mm	3/4	12	28	36	32	500	100	pce	POA

GF Aquasystem union PPR green PN10

- * PN10 hot and cold water applications.
- ** PN10 cold water applications only.

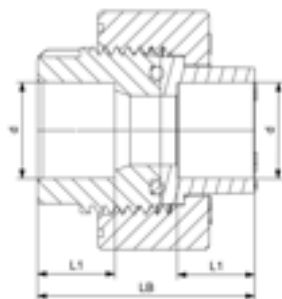

Item No.	Item no. GF	In/Out	Dimensions	L mm	W mm	H mm	W kg	Pallet/ Pack	Box/M QTY	UOM	Price per m/each
1148847	4302902028021		20mm	50	50	45	0,04	200	50	pce	POA
1148876	4302902528121		25mm	60	60	50	0,06	125	25	pce	POA
1148896	4302903228221		32mm	66	66	55	0,091	80	20	pce	POA
1148911	4302904028321		40mm	80	80	60	0,147	50	10	pce	POA
1148927	4302905028421		50mm	90	90	70	0,191	30	5	pce	POA
1148943	4302906328521		63mm	110	110	72	0,316	20	4	pce	POA
1148967	4302909032521	OUT	90mm	156	156	95	0,775	8	1	pce	POA

GF Aquasystem Distribution Manifold PPR green

- PP-R Green material

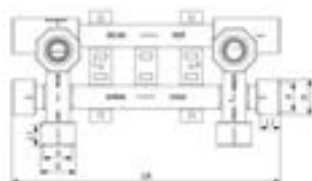

Item No.	Item no. GF	Dimensions	L mm	W mm	H mm	W kg	Pallet/ Pack	Box/M QTY	UOM	Price per m/each
1148830	4302902002321	6x1/2"-20mm	112	236	60	0,3038	15	3	pce	POA

Aquasystem

GF Aquasystem Chromium Valve Long PPR green

- PP-R Green material
- Chromium valve



Item No.	Item no. GF	Dimensions	l2 mm	l3 mm	Pallet/ Pack	Box/M QTY	UOM	Price per m/each
1148800	4302802040121	1/2"-20	115,0	68,0	50	10	pce	POA
1148807	4302802540321	3/4"-25	125,0	78,0	40	10	pce	POA
1148815	4302803240521	1" 32	135,0	88,0	40	5	pce	POA

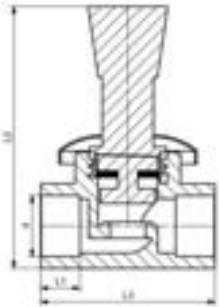

GF Aquasystem chromium valve PPR green

- PP-R Green material
- Chromium valve



Item No.	Item no. GF	Dimensions	l mm	Pallet/ Pack	Box/M QTY	UOM	Price per m/each
1148799	4302802040021	1/2" 20	59,2	50	10	pce	POA
1148806	4302802540221	3/4" 25	77,5	40	10	pce	POA
1148814	4302803240421	1" 32	88,0	40	5	pce	POA

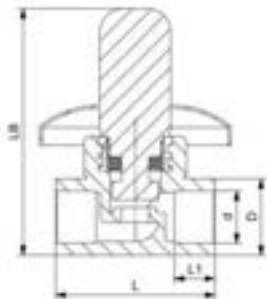

Aquasystem

GF Aquasystem gate valve PPR green

- PP-R Green material

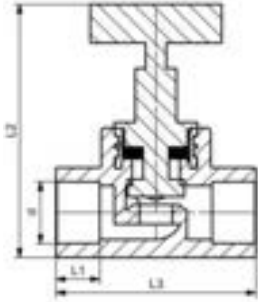

Item No.	Item no. GF	Dimensions	L2 mm	L3 mm	Pallet/ Pack	Box/M QTY	UOM	Price per m/each
1148798	4302802035021	1/2" 20	94,8	59,2	75	15	pce	POA
1148805	4302802535121	3/4" 25	98,7	77,5	60	10	pce	POA
1148813	4302803235221	1" 32	107,2	88,0	40	5	pce	POA

GF Aquasystem gate valve - new PPR green

- PP-R Green material

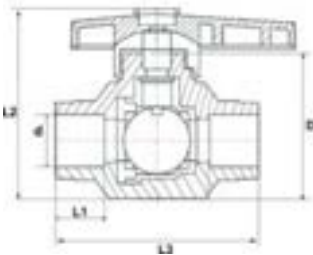

Item No.	Item no. GF	Dimensions	L2 mm	L3 mm	Pallet/ Pack	Box/M QTY	UOM	Price per m/each
1148819	4302803243022	32mm	92,0	68,0	45	5	pce	POA

GF Aquasystem gate valve PPR green

- Material: PPR green

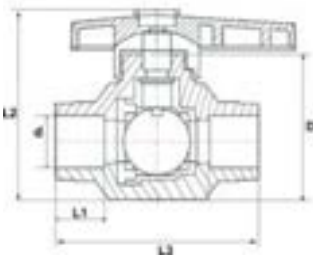

Item No.	Item no. GF	Dimensions	L2 mm	L3 mm	Pallet/ Pack	Box/M QTY	UOM	Price per m/each
1148804	4302802042822	20mm	72,0	88,0	100	10	pce	POA

Aquasystem

GF Aquasystem Ball Valve PPR green

- PN10 cold water applications only.

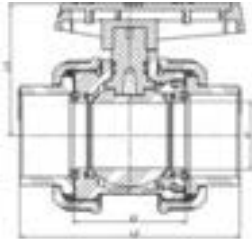

Item No.	Item no. GF	Dimensions	l2 mm	l3 mm	Pallet/ Pack	Box/M QTY	UOM	Price per m/each
1148803	4302802042522	20mm	83,0	48,0	70	10	pce	POA
1148810	4302802542622	25mm	95,0	55,0	50	10	pce	POA
1148811	4302802542922	25mm	82,0	76,0	70	10	pce	POA
1148818	4302803242722	32mm	105,0	65,0	30	6	pce	POA
1148821	4302804043622	40mm	121,4	109,1	25	1	pce	POA
1148820	4302804043122	40mm	122,0	76,0	15	5	pce	POA
1148823	4302805043722	50mm	140,0	125,2	20	1	pce	POA
1148822	4302805043222	50mm	143,0	87,0	12	3	pce	POA
1148825	4302806343822	63mm	121,1	119,3	15	1	pce	POA
1148824	4302806343322	63mm	167,0	101,0	8	2	pce	POA
1148826	4302807543922	75mm	159,5	144,9	8	1	pce	POA

GF Aquasystem Reducing Tee Green

Item No.	Item no. GF	In/Out	Dimensions	L mm	W mm	H mm	W kg	Pallet/ Pack	Box/M QTY	UOM	Price per m/each
1148981	4302916021922	12.26	160x110x160mm	424	170	277	4,85	96	2	pce	POA

JRGUMAT



JRGUMAT thermostatic mixing valves are thermostatically controlled mixing valves that can be used wherever a constant mixed water temperature with high control accuracy is desired or required.

Specification

- Dimension range DN15 – DN80
- Different temperature ranges (20-80°C) and factory settings (e.g. 25, 40, 55 and 70°C)

GF JRGUMAT thermostatic mixing valve 3400 40°C

- Temperature: max. 90°C
- Nominal pressure: PN10
- Factory setting: 40°C (30-45°C)
- Material: gunmetal
- Connection: male thread

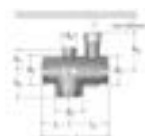

Benefits

- Supplies mixed hot water at a safe and constant temperature
- Protects against scalding
- High control accuracy
- Operates without auxiliary energy
- Energy saving
- Increases user comfort and safety

Application

- For use within potable water systems
- Safe and constant mixed water temperature
- Excess-temperature protection in systems using alternative forms of energy such as solar thermal and bio-mass energy systems
- Central and decentralized hot water mixing for single family and multi-family homes, hospitality buildings and sports facilities

Item No.	Item no. GF	Dimensions	d2 G inch	d3 G inch	DN mm	h1 mm	h2 mm	h3 mm	l1 mm	l2 mm	l mm	PN bar	range °C	Size inch	Temperature °C	Thread Type	Pallet/ Pack	Box/M QTY	UOM	Price per m/
1149492	350760312	DN25	1 1/2	3/4	25	36	51	43	43	67	110	10	30 - 45	1	40	GN	5	1	pce	POA
1149482	350760212	DN32	2	3/4	32	41	75	52	52	78	130	10	30 - 45	1 1/4	40	GN	8	1	pce	POA
1149459	350760012	DN50	2 3/4	3/4	50	60	85	70	70	110	180	10	30 - 45	2	40	GN	8	1	pce	POA

JRGUMAT

GF JRGUMAT thermostatic mixing valve 3400 55°C

- Temperature: max. 90°C
- Nominal pressure: PN10
- Factory setting: 55°C (45-65°C)
- Material: gunmetal
- Connection: male thread

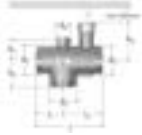

Item No.	Item no. GF	Dimensions	d2 G inch	d3 G inch	DN mm	h1 mm	h2 mm	h3 mm	l1 mm	l2 mm	l mm	PN bar	range °C	Size inch	Temperature °C	Thread Type	Pallet/ Pack	Box/M QTY	UOM	Price per m/
1149483	350760213	DN32	2	3/4	32	41	75	52	52	78	130	10	45 - 65	1 1/4	55	GN	8	1	pce	POA
1149473	350760113	DN40	2 1/4	3/4	40	50	77	58	58	92	150	10	45 - 65	1 1/2	55	GN	8	1	pce	POA
1149460	350760013	DN50	2 3/4	3/4	50	60	85	70	70	110	180	10	45 - 65	2	55	GN	8	1	pce	POA

GF JRGUMAT thermostatic mixing valve 3410 55°C

- Temperature: max. 90°C
- Nominal pressure: PN10
- Factory setting: 55°C (45-65°C)
- Material: gunmetal
- Connection: flange

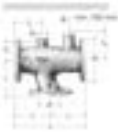

Item No.	Item no. GF	Dimensions	d1 mm	d2 G inch	d3 mm	d mm	DN mm	h1 mm	h2 mm	l1 mm	l2 mm	l3 mm	PN bar	range °C	Temperature °C	mm	Pallet/ Pack	Box/M QTY	UOM	Price per m/each
1149522	350767216	DN65	65	1 1/2	185	65	65	82	121	145	290	112	10	45 - 65	55	8 4	1	1	pce	POA
1149531	350767416	DN80	80	2	200	80	80	92	127	155	310	124	10	45 - 65	55	8 8	1	1	pce	POA

GF JRGUMAT sealing cap 3400

- Description: to JRGUMAT 3400
- Material: brass



Item No.	Item no. GF	Dimensions	d1 G inch	DN mm	GN inch	h mm	PN bar	Size inch	Pallet/ Pack	Box/M QTY	UOM	Price per m/each
1155804	350756801	DN20	3/4	20	3/4	9	10	3/4	10	1	pce	POA

GF JRGUMAT sealing cap 3410

- Description: to JRGUMAT 3410
- Material: brass



Item No.	Item no. GF	Dimensions	d1 G inch	DN mm	GN inch	h mm	PN bar	Size inch	Pallet/ Pack	Box/M QTY	UOM	Price per m/each
1155809	350769801	DN40	1 1/2	40	1 1/2	11	10	1 1/2	1	1	pce	POA

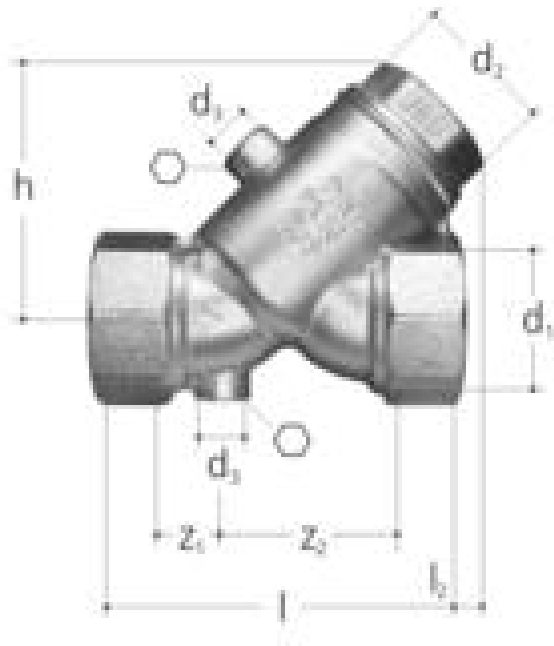

Benefits

- Hygienic design with a water-pocket-free construction and high-quality materials that meet the highest hygiene standards.
- Outstanding long-term performance is achieved through intelligent engineering, premium materials, and years of proven experience.
- Corrosion resistance is ensured by the use of high-quality gunmetal and stainless steel components.
- Extensive product portfolio with a wide range of valve families and multiple jointing technologies for both hot and cold water applications.

Best-in-class sanitary valves for hot and cold water distribution, control, and installation reliability - engineered with Swiss precision and quality.

Our valves and water control solutions include pressure management for safety in pipe systems, temperature management to solve the most difficult installations, and digital solutions for better monitoring and alerting. With our installation-friendly offering we help to secure the installation, the building, and everybody in it, ensure safe water supply that meets the most stringent drinking water regulations, and help prevent water waste while providing the highest comfort possible.

Specification

- Wide product range
- Gunmetal body

Application

Potable water installations

GF JRG non-return valve with screw connection

- Temperature: max. 90°C
- Nominal pressure: PN16
- Material: gunmetal, stainless steel, EPDM, plastic
- Opening pressure: < 5 kPa (< 50 mbar)
- Connection: screw connection



Item No.	Item no. GF	Dimensions	d1 G	d2 G	d3 Rp	DN	h	l3	l4	l5	l	PN	Size	Pallet/ Pack	Box/M QTY	UOM	Price per m/
			inch	inch	inch	mm	mm	mm	mm	mm	mm	bar	inch	mm			
1157432	350898302	DN65	3	2 1/2	1/4	65	116	43	147	15	190	16	2 1/2	6	1	pce	POA

JRGURED



Benefits

- Optimized flow, high Kvs
- Reduced flow noise
- High-quality materials that meet the highest hygiene standards.
- Robust construction to ensure outstanding long-term performance
- High-quality gunmetal and stainless steel components provides exceptional corrosion resistance.
- Compact design

JRGURED is a pressure reducing valve (PRV) that meets the highest standards for durability and precision.

JRGURED protects buildings, equipment and the building's occupants by reducing the downstream pressure, preventing pressure surges and reducing unwanted noise in the water system - e.g. mains water pressure entering a building, or for water circuits connected to boosted services.

The pressure set by the factory can be adjusted to the hydraulic conditions and demands of the system. Each valve also contains a 1'000 µm filter to protect the installation and its valves from blockage and malfunction.

Specification

- Dimension range DN15 – DN100
- Three different pressure ranges (0.5 – 2bar, 2 – 6bar, and 6 – 10 bar) with factory settings (e.g. 2, 4 and 6 bar)

GF JRGURED pressure reducing valve 1303 4bar

- Description: pressure gauge connection on both sides, plastic filter cup, without unions
- Temperature: max. 30°C
- Nominal pressure: PN25
- Material: gunmetal, stainless steel, EPDM, plastic
- Factory setting: 400 kPa (4 bar), adjustable on site 200 - 600 kPa (2 - 6 bar)
- Connection: screw connection



Item No.	Item no. GF	Dimensions	d2 G inch	d3 Rp inch	d4 mm	DN mm	GN inch	h1 mm	h2 mm	l1 mm	PN bar	Size inch	z mm	Pallet/ Pack	Box/M QTY	UOM	Price per m/
1157300	350740401	DN32	1 1/2	1/4	72	32	1 1/4	67	109	120	25	1 1/4	60	6	1	pce	POA

JRGURED

GF JRGURED pressure reducing valve 1330 6bar

- Description: pressure gauge connection on both sides, gunmetal filter cup, with unions
- Temperature: max. 70°C
- Nominal pressure: PN25
- Material: gunmetal, stainless steel, EPDM, plastic
- Factory setting: 600 kPa (6 bar), adjustable on site 600 - 1000 kPa (6 - 10 bar)
- Connection: male thread

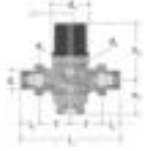

Item No.	Item no. GF	Dimensions	d1 R	d2 G	d3 Rp	d4	DN	GN	h1	h2	l1	l2	PN	Size	z	Pallet/ Pack	Box/M QTY	UOM	Price per m/
			inch	inch	inch	mm	mm	inch	mm	mm	mm	mm	bar	inch	mm	mm			
1157299	350740361	DN25	1	1 1/4	1/4	60	25	1	55	90	167	34	25	1	50	5	1	pce	POA

JRGARANT



The JRGARANT safety valve protects closed-type water heaters and systems against excessive pressures.

When water is heated, it expands, leading to an increase in pressure within the vessel. The non-return valve integrated into the supply line prevents water from flowing back from the water heater into the distribution network. Once the factory-set response pressure is reached, the safety valve opens and discharges the excess water that caused the overpressure into the drainage system.

Specification

- Dimension range DN15 – DN25
- Standard with factory setting 6 bar, other response pressures from 1 to 10 bar are available on request.

GF JRGARANT pressure relief valve 6bar

- Temperature: 90°C
- Nominal pressure: PN10
- Material: gunmetal
- Factory setting: 600 kPa (6 bar)
- Connection: inlet male thread, outlet female thread



Item No.	Item no. GF	Dimensions	d1	R	d2	Rp	DN	GN	h1	h2	l1	l2	PN	Size	Temperature	z	Pallet/ Pack	Box/M QTY	UOM	Price per m/
			inch	inch	mm	inch	mm	mm	mm	mm	mm	mm	bar	inch	°C	mm				
1157117	350599610	DN25	1	1	25	1	39	65	46	49	10	1	90		22		1	pce	POA	

Benefits

- Reliable overpressure safety protection
- Pre-set opening pressure for consistent performance
- Simple maintenance
- Lasting reliability due to gunmetal body and high-quality components (e.g. valve seat made of stainless steel)

Application

Potable water installation in supply line to hot water heater

GF JRG union with female thread

- Description: to 3400, 3410, 5120
- Material: gunmetal
- Connection: female thread
- Supplied with: flat gasket AFM34



Item No.	Item no. GF	Dimensions	d1 Rp inch	d2 G inch	DN mm	GN inch	l1 mm	l2 mm	z mm	Pallet/ Pack	Box/M QTY	UOM	Price per m/each
1155702	350253501	DN32	1 1/4	2	32	1 1/4	10	29	10	5	1	pce	POA
1155706	350253701	DN50	2	2 3/4	50	2	14	36	12		1	pce	POA

GF JRG union with male thread

- Description: to 1300-1333, 1350-1363, 2100-2110, 2113, 2130-2140, 2143, 8201.402, 9601.040, 9606.040, 9695.480, 6214-6215
- Supplied with: flat gasket AFM34
- Material: brass
- Connection: male thread

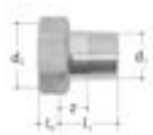

Item No.	Item no. GF	Dimensions	d1 R inch	d2 G inch	DN mm	GN inch	l1 mm	l2 mm	z mm	Pallet/ Pack	Box/M QTY	UOM	Price per m/each
1155730	350331901	DN25	1	1 1/4	25	1	34	8	15	10	1	pce	POA
1155737	350332201	DN50	2	2 3/8	50	2	47	11	21		1	pce	POA

Hyclean AS



Benefits

- Managing and documenting the supply of hygienic, safe hot water
- Controls temperatures and prevents stagnation (flushing protocol must be approved)
- Energy efficiency by optimized hydraulic balancing
- High comfort with short hot water output times
- Simple and fast plug-and-play solution with a central point of access (Master)
- Easy management with optional cloud-based, remote access
- Documentation of temperatures with clear, digital protocols
- Alert and self-maintenance functions

The Hyclean Automation System is a digitally enhanced solution for monitoring and controlling domestic water installations.

Electronic valves and sensors monitor and regulate hydraulic balancing and prevent long stagnation periods. Hyclean AS continuously controls and maintains the process of hydraulic balancing in a highly effective and efficient way. All data relating to the system performance can be accessed from a central control.

This end-to-end solution combines sensors and digitized valves, connected to a central master unit. The digitally controlled balancing valves automatically optimize and perform the hydraulic balancing. The flushing valves ensure a temperature, time, or user demand-controlled flushing of stagnant, and unhygienic water from systems without circulation (often the cold water lines).

This innovative system addresses the critical risk factors of domestic water installations and offers remote, cloud-based, centrally-controlled maintenance functions.

Specification

- Balancing valves: DN 15, 20, 25
- Flush valves: DN 15 & 20
- Central control interface with touch-screen
- Operating pressure: to 10 bar
- Operating temperature: +5°C to +90°C
- Materials: Gunmetal, Stainless steel, Plastics

Application

- Balancing of potable water hot circulation systems
- Ensure water exchange in potable water hot & cold pipe sections
- For buildings with complex water installations
- Ideal for retro-fit where existing installations experience poor hot water supply to outlets

Hyclean AS

GF Hyclean AS Master

- Description: Master for max. 50 Hyclean AS Controller
- Consisting of: touchscreen 10.1", power supply
- 2 plugs M12 for 2x 300m cable (500m with powerbox)
- 2 RJ45 jacks (Ethernet), 2 USB connections (read/write)
- USB jack (read only), relay output
- Screw set



Item No.	Item no. GF	Dimensions	b mm	h mm	l mm	Version	Voltage	Pallet/ Pack	Box/M QTY	UOM	Price per m/each
1149728	351110656	EU	84	214	326	EU	230V / 36V		1	pce	POA
1149736	351110679	UK	84	214	326	UK	230V / 36V		1	pce	POA

GF Hyclean AS Powerbox

- Description: Power supply of Hyclean Automation System
- for expansion of 300m cable length to max. 500m per cable line
- Consisting of: 2m power cable
- Screw set



Item No.	Item no. GF	Dimensions	b mm	h mm	l mm	Version	Voltage	Pallet/ Pack	Box/M QTY	UOM	Price per m/each
1149731	351110659	UK	64	164	244	UK	230V / 36V		1	pce	POA

GF Hyclean AS balancing valve LegioTherm 2T

- Temperature: max. 90°C
- Nominal pressure: PN10
- Material: gunmetal lead-free, stainless steel, EPDM
- Factory setting: 57°C (adjustable 0 - 90°C) thermal disinfection 70°C (adjustable 60 - 90°C)
- Connection: screw connection



Item No.	Item no. GF	Dimensions	b mm	d1 G inch	d2 G inch	d3 Rp inch	DN	h1 mm	h2 mm	l1 mm	l2 mm	l3 mm	l4 mm	PN bar	Size inch	mm	Pallet/ Pack	Box/M QTY	UOM	Price per m/
1149709	351110550	DN15	90	3/4	1/2	1/4	15	162	50	75	6	24	173	10	1/2	6		1	pce	POA
1149718	351110590	DN20	92	1	3/4	1/4	20	169	54	87	7	24	206	10	3/4	6		1	pce	POA
1149724	351110630	DN25	100	1 1/4	1	1/4	25	179	56	99	8	24	233	10	1	6		1	pce	POA

Hyclean AS

GF Hyclean AS flush valve LegioTherm K

- Temperature: max. 90°C
- Nominal pressure: PN10
- Material: gunmetal lead-free, stainless steel, EPDM
- Factory setting: 20°C (adjustable 0 - 90°C)
- Connection: screw connection
- Note: Flushing valve JRG LegioTherm K must not be used without the consent of the holder of patents EP 1 845 207 B1 and DE 10 2006 017 807 B4 for use in a water system of the type described in these patents.



Item No.	Item no. GF	Dimensions	b	d1	G	d1	d2	G	d2	d3	Rp	d3	DN	h1	h2	l1	l2	l3	l4	PN	Pallet/ Pack	Box/M QTY	UOM	Price per m/each
			mm	inch	inch	inch	inch	inch	inch	inch	inch	inch	mm	mm	mm	mm	mm	mm	mm	bar	mm			
1149719	351110600	DN15	90	3/4	3/4	1/2	1/2	1/4	1/4	15	162	50	75	6	24	173	10	6			1	pce	POA	
1149720	351110610	DN20	92	1	1	3/4	3/4	1/4	1/4	20	169	54	87	7	24	206	10	6			1	pce	POA	

GF Hyclean AS power supply & communication cable

- Description: For serial connection of Hyclean Automation System components (master, controller)
- incl. 2x M12 plugs, ROHS



Item No.	Item no. GF	Dimensions	d1	d	L	Voltage	Pallet/ Pack	Box/M QTY	UOM	Price per m/each
			mm	mm	m	V				
1149711	351110581	1,5m	6.8	14.5	1.5	36V		1	pce	POA
1149708	351110541	3m	6.8	14.5	3	36V		1	pce	POA
1149712	351110582	5m	6.8	14.5	5	36V		1	pce	POA
1149713	351110583	10m	6.8	14.5	10	36V		1	pce	POA

GF Hyclean AS coupling

- Description: Coupling between 2 Hyclean Automation power supply and communication cable
- Connection: plug M12



Item No.	Item no. GF	Dimensions	h	l	Pallet/ Pack	Box/M QTY	UOM	Price per m/each
			mm	mm				
1149716	351110586	M12-M12	14	58		1	pce	POA

GF Hyclean AS Connect licence

- Cloud-based remote access for digital monitoring and control of potable water installations. Remote monitoring, Remote access, Alarms, Asset manager, Data mangement.
- Register your Hyclean Master online at hyclean.gfdigitalcontrols.com/
- Purchase your Hyclean Connect remote access subscription
- Hyclean Connect is a subscription service that runs on a yearly fee basis
- The Internet connection from Hyclean Master to the cloud must be provided by the user



Item No.	Item no. GF	L	W	H	W	Pallet/ Pack	Box/M QTY	UOM	Price per m/each
		mm	mm	mm	kg				
1149757	351110795	0.1	0.1	0.1	0,001			pce	POA

Hyclean AS

GF Hyclean AS insulation set

- Description: insulation shell
- Material: EPP



Item No.	Item no. GF	Dimensions	h mm	Pallet/ Pack	Box/M QTY	UOM	Price per m/each
1149737	351110680	DN15	173 90 147 0,054		1	pce	POA
1149738	351110681	DN20	155		1	pce	POA

GF Hyclean AS Relay cable Uni Controller

- Cable to connect the Uni Controller relay connector (24V/230V)
- with actuators controlled via the actuator automation application.
- Connection: RD24 plug, female



Item No.	Item no. GF	Dimensions	l1 mm	l m	Pallet/ Pack	Box/M QTY	UOM	Price per m/each
1149734	351110672	5m	63	5		1	pce	POA

GF Hyclean AS 4-20mA cable Uni Controller

- Cable to connect Uni Controller 4-20 mA connectors with actuators.
- Control and programming of actuators via the master.
- Connection: M12 Plug



Item No.	Item no. GF	Dimensions	L mm	W mm	H mm	W kg	Pallet/ Pack	Box/M QTY	UOM	Price per m/each
1149735	351110674	5m	5000	15	15	0,2		1	pce	POA

GF Hyclean AS controller balancing valve

- Description: spare part Controller LegioTherm 2T balancing valve



Item No.	Item no. GF	Dimensions	L mm	W mm	H mm	W kg	Pallet/ Pack	Box/M QTY	UOM	Price per m/each
1149745	351110690	DN15	143	127	107	0,463		1	pce	POA
1149747	351110692	DN20	143	127	107	0,463		1	pce	POA
1162880	351110789	DN25	143	127	107	0,463		1	pce	POA

Hyclean Balance



Benefits

- Continuously optimized hydraulic balancing, based on actual temperatures
- Quick planning and easy integration due to wide Kv range
- Quick start guaranteed with commissioning wizard
- Efficiency and peace of mind for building operators, FM and owners/investors
- Documentation and visualization of temperatures
- Easy integration into BMS systems via Modbus RTU
- Automated function checks and maintenance procedures
- Lasting reliability due to gunmetal body and high-quality electrical and mechanical components

Hyclean Balance is GF's stand-alone digital balancing valve used to optimise DHW recirculation systems by temperature-controlled digital hydraulic balancing.

Installation and commissioning is simple using plug & play connectivity. Following a simple commissioning process, Hyclean Balance is fully automated. Temperatures and system performance can be monitored via a simple Bluetooth data transfer.

Specification

- Dimension range DN 15 & 20
- Power supply, serial cabling
- Access via smartphone app

Application

- Potable water hot circulation (DHW-C)

GF Hyclean Balance balancing valve

- Description: digital hydraulic balancing valve
- Temperature: delivery state: 57°C (setting range: 0-90°C), thermal disinfection (60-90°C)
- Nominal pressure: PN10
- Material: material: Gunmetal lead-free (RG+), stainless steel, EPDM

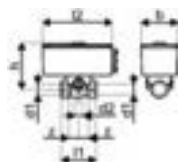

Item No.	Item no. GF	In/Out	Dimensions	L mm	W mm	H mm	W kg	Pallet/ Pack	Box/M QTY	UOM	Price per m/each
1162345	351112115	03.26	DN15	120	63	95	0,673		1	pce	POA
1162346	351112120		DN20	120	63	109	0,833		1	pce	POA

Hyclean Balance

GF Hyclean Balance Controller - spare part

- spare part to Hyclean Balance



Item No.	Item no. GF	In/Out	Dimensions	L mm	W mm	H mm	W kg	Pallet/ Pack	Box/M QTY	UOM	Price per m/each
1185330	351112191	03.26	DN15	128.1	63	70.6	0,385		1	pce	POA
1185331	351112192	03.26	DN20	128.1	63	79.7	0,4		1	pce	POA

Hyclean Flush



Benefits

- Used for the prevention of water stagnation in drinking water systems
- The use of flushing valves must be approved
- Plug & Play cable connectors for easy and quick installation
- Accessories can be used for various Hyclean electronic valves

The electronic flush valve offers two primary functions: automated flushing and programmable shut-off.

The flushing function ensures optimal water hygiene by enabling automated, demand-controlled water exchange to prevent stagnation and unfavorable temperatures.

The shut-off function allows for automated or remote opening and closing via app or Building Management System (BMS), providing leak protection, access control, and enhanced operational safety.

Potable water flushing systems must comply with the Water Supply (Water Fittings) Regulations 1999

Specification

- Dimension range DN 15 & 20
- Power supply, serial cabling
- Access via smartphone app

GF Hyclean Flush & Shut-Off Valve

- digital flush and shut-off valve
- Nominal pressure: PN10
- Material: Gunmetal lead-free (RG+), stainless

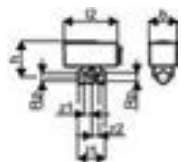

Application

Potable water installations

Item No.	Item no. GF	In/Out	Dimensions	L mm	W mm	H mm	W kg	Pallet/ Pack	Box/M QTY	UOM	Price per m/each
1185323	351112215	03.26	DN15	120	63	95	0,673		1	pce	POA
1185324	351112220	03.26	DN20	120	63	109	0,833		1	pce	POA

Hyclean



Benefits

- Complete accessory portfolio for Hyclean hygiene flushing systems
- Reliable power supply and signal transmission
- Enhanced monitoring of temperature, flow and leakage
- Easy system expansion and integration into BMS
- Reliable installation protection and operation

The Hyclean range consists of accessories and system components designed to support, extend and integrate Hyclean Balance and Hyclean Flush hygiene systems.

The range encompasses power supply, communication, sensing, monitoring and system integration to ensure reliable drinking water hygiene.

Specification

- 30 V DC power supplies for Hyclean Balance and Flush systems
- Communication and extension cables with M8 push-pull connectors
- BMS connection via Modbus RTU
- Temperature sensors PT1000 and 4–20 mA sensor adapters
- Flow sensors and drain surveillance sensors
- Insulation shells made of EPP for DN15 and DN20 valves
- Sensor extension cables and spare sensor components

Application

- Power supply and electrical connection of Hyclean Balance and Flush systems
- Communication and bus extension between Hyclean components
- Integration with building management systems (BMS)
- Temperature, flow, and leakage monitoring in drinking water installations
- Protection, insulation and installation support of hygiene flushing valves

GF Hyclean Power Supply

- 30V DC power supply for Hyclean Balance / Flush
- Circulation control valves, max. 100m cable lengths and 10x valves
- Consisting of: 1.5m power cable

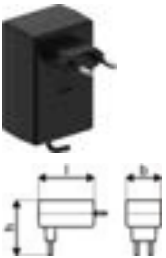

Item No.	Item no. GF	In/Out	Dimensions	L mm	W mm	H mm	W kg	Pallet/ Pack	Box/M QTY	UOM	Price per m/each
1162883	351112141	03.26	1.5m	160	130	80	0,22		1	pce	POA

Hyclean

GF Hyclean power supply and communication cable push-pull

- 30V DC power supply for Hyclean Balance / Flush
- Circulation control valves, max. 100m cable lengths and 10x valves
- Consisting of: 1.5m power cable

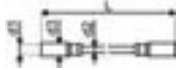

Item No.	Item no. GF	In/Out	Dimensions	L mm	W mm	H mm	W kg	Pallet/ Pack	Box/M QTY	UOM	Price per m/each
1162884	351112151	03.26	1.5m	260	260	15	0,055		1	pce	POA
1162885	351112152	03.26	3m	260	260	18	0,108		1	pce	POA
1162886	351112153	03.26	5m	260	260	20	0,18		1	pce	POA
1162887	351112154	03.26	10m	260	260	25	0,355		1	pce	POA
1185329	351112155	03.26	20m	260	260	40	0,85		1	pce	POA

GF Hyclean cable coupling

- Coupling for connecting two Hyclean Balance / Flush cables or extending the power cable with pre-assembled push/pull plug
- M8 plug connection

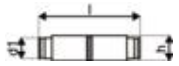

Item No.	Item no. GF	In/Out	L mm	W mm	H mm	W kg	Pallet/ Pack	Box/M QTY	UOM	Price per m/each
1162888	351112156	03.26	130	85	15	0,015		1	pce	POA

GF Hyclean BMS connect & bus extension

- Y-cable for connection to building management system via Modbus RTU and for bus extension with additional power supply.
- Connection: 2 core cable

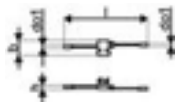
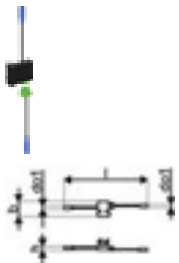

Item No.	Item no. GF	In/Out	L mm	W mm	H mm	W kg	Pallet/ Pack	Box/M QTY	UOM	Price per m/each
1185326	351112157	03.26	250	200	20	0,15		1	pce	POA

GF Hyclean Insulation shell

- Hyclean Balance / Flush insulation shell for valve DN 15 and DN 20
- Self-adhesive, black, made of EPP

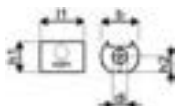

Item No.	Item no. GF	In/Out	Dimensions	L mm	W mm	H mm	W kg	Pallet/ Pack	Box/M QTY	UOM	Price per m/each
1162882	351112161	03.26	DN15/20	140	120	100	0,035		1	pce	POA

Hyclean

GF Hyclean flow sensor

- Temperature: max. 90°C
- Nominal pressure: PN16
- Material: brass
- Connection: screw connection, cable plug M8



Item No.	Item no. GF	Dimensions	d G inch	DN mm	h1 mm	h2 mm	h mm	l1 mm	l mm	PN bar	Pallet/ Pack	Box/M QTY	UOM	Price per m/each
1149751	351110772	DN20	1	20	49	32	999	15	60	16		1	pce	POA

GF Hyclean temperature sensor

- Description: Temperature sensor PT 1000
- Temperature: max. 90°C
- Connection: cable plug M8



Item No.	Item no. GF	L mm	W mm	H mm	W kg	Pallet/ Pack	Box/M QTY	UOM	Price per m/each
1149721	351110611	200	200	30	0,15		1	pce	POA

GF Hyclean AS temperature sensor with valve

- Description: Temperature sensor PT 1000 with valve
- Temperature: max. 90°C
- Material: gunmetal
- Connection: screw connection, cable plug M8



Item No.	Item no. GF	Dimensions	d1 inch	G inch	d2 inch	G inch	d3 inch	d4 inch	Rp mm	d mm	h1 mm	h mm	l1 mm	l mm	Pallet/ Pack	Box/M QTY	UOM	Price per m/each
1149732	351110661	DN20	1	3/4	1	1/4	20	168	52	87	206		1	pce	POA			

Radiant Heating and Cooling



Thermatop



Benefits

- Seamless and directionless heating or cooling ceiling surfaces
- Architecturally desirable
- High heating and cooling capacities with high energy efficiency
- Clear separation of trades between dry construction and radiant installation
- No draughts and no operational noise

The Uponor Thermatop range consists of water-based radiant ceiling heating and cooling system designed for seamless integration into plasterboard ceilings.

Prefabricated emitters are clicked directly into the ceiling substructure, enabling fast installation and high thermal comfort for commercial buildings.

Specification

- Water-based radiant ceiling heating and cooling system
- Prefabricated ceiling emitters for dry construction
- Tool-free installation into CD ceiling profiles
- Designed for low-temperature heating and efficient cooling

Application

- Radiant ceiling heating and cooling in commercial and public buildings
- Use in offices, schools, healthcare buildings and large open spaces
- Integration into suspended plasterboard ceiling systems
- Heating and cooling with one water-based solution

Uponor Thermatop M

- Emitter made of 16 x 2,0 mm Uni Pipe PLUS with 10 pipe rows and up to 37,3 m per m² module.
- For grid distances of CD-profiles of 333mm
- The pipe is 100% diffusion-resistant according to DIN 4726.
- Cooling capacity according to EN 14240 (8K) up to 67 W/m²
- Heating capacity according to EN 14037 (15K) up to 105 W/m².
- Sound absorption according to DIN EN ISO 354 with α_w between 0,60 to 0,65.
- Capacity and acoustic values depending on gypsum board.

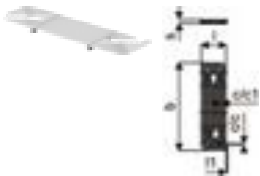

Item No.	Dimensions	c/c mm	c/c1 mm	l1 mm	l mm	s mm	b mm	Pallet/ Pack	Box/M QTY	UOM	Price per m/each
1090933	950x277mm	24,3	27,7	17,4	277	47	950	200	10	pce	69,57
1090934	1350x277mm	24,3	27,7	17,4	277	47	1350	200	10	pce	92,80
1090935	1750x277mm	24,3	27,7	17,4	277	47	1750	200	10	pce	120,73

Magna



Benefits

- Easy and flexible: optimal use of space, few components
- Cost efficient: rapid return on investment, no maintenance costs
- Energy efficient: suitable for low temperature heat sources
- Reliable: long-life, proven technology
- Comfortable: constant temperature, no dust

Uponor Magna is built directly into the basement concrete. The standard steel mats are used for pipe fixation. Any warm water heating system can be used.

Application

- industrial and commercial large surface heating
- for use inside concrete
- max. 20 loops
- max. pressure: 6 bar at 60°C

Specification

- Magna industrial heating system
- Loops 2-5 6-9 10-14 15-19 20
- Bracket 2 3 4 5 6
- Spacing outlet 100 mm

Uponor Magna return valve inset

- for Magna valves



Item No.	L mm	W mm	H mm	W kg	Pallet/ Pack	Box/M QTY	UOM	Price per m/each
1059436	30	30	70	0,03		5	pce	107,09

Uponor Magna supply valve inset

- for Magna valves



Item No.	L mm	W mm	H mm	W kg	Pallet/ Pack	Box/M QTY	UOM	Price per m/each
1059437	30	30	70	0,03		5	pce	92,56

Uponor Magna clamp track nail

- clamp track fixation clip
- for pipes 25 mm

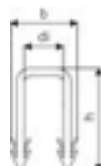

Item No.	Dimensions	di mm	di1 mm	b mm	h mm	Pallet/ Pack	Box/M QTY	UOM	Price per m/each
1005291	25mm	18	18	29	49	5000	500	pce	0,22

Magna

Uponor Magna edging strip, self-adh

- edging strip for Magna system
- made of polyethylene with self-adhesive backing, self-adhesive strip on outer face
- provides tight seal between edging strip and insulation



Item No.	Dimensions	s mm	b mm	Pallet/ Pack	Box/M QTY	UOM	Price per m/each
1020182	50m 200x10mm	10	200		50	m	2,25

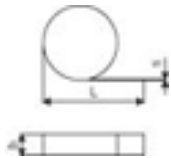

Uponor Magna expansion protective pipe

- made of PE-LD
- for protection of UFH pipes 25mm in areas of expansion joints



Item No.	Dimensions	L mm	W mm	H mm	W kg	Pallet/ Pack	Box/M QTY	UOM	Price per m/each
1030631	34/28mm 25m	1000	35	35	0,1	1250	25	m	1,87

Uponor Magna manifold kit K1

- Includes:
- 2x brackets short
- 2x brackets long
- 2x filling valve brass
- 2x thermometer 0 - 60°C
- 1x manometer
- 2x endcap
- 2x flat sealing screw connection piece with swivel nut
- 1x mounting material: 8x screws 6x60mm, 8x plastic anchor 8x40mm, 2x flat sealing 44x32x2



Item No.	L mm	W mm	H mm	W kg	Pallet/ Pack	Box/M QTY	UOM	Price per m/each
1045815	140	70	22	1,4	108	1	pce	258,40

Magna

Uponor Magna manifold segment w. valve

- For connection with additional segments and basic kit
- Supply-segment with control valves for preadjustment
- Return-segment with thermostat upper section incl. cap for locking
- Uponor actuator can be mounted directly on the return
- Heating loop connection for PE-Xa Pipe 25x2,3 with compression adapter

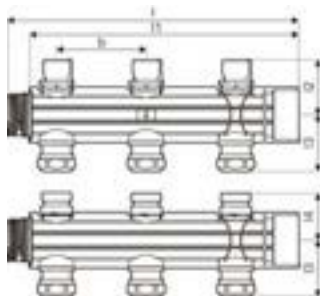

Item No.	Dimensions	p bar	Pallet/ Pack	Box/M QTY	UOM	Price per m/each
1121535	1x25	100 370 56 0,674	10	1	pce	113,79
1121536	2x25	226 112 169 1,322	90	1	pce	226,95
1121537	3x25	326 112 169 1,986	60	1	pce	340,13

Uponor Magna manifold segment w. valve

- For connection with additional segments and basic kit
- Supply-segment with control valves for preadjustment and heating loop connection for G3/4 eurocone
- Return-segment with thermostat upper section incl. cap for locking
- Uponor actuator can be mounted directly on the return
- Heating loop connection for G3/4 eurocone

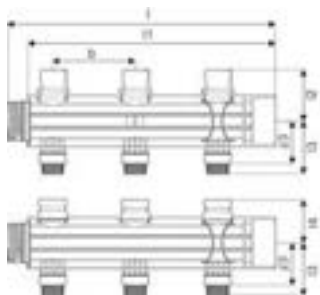

Item No.	Dimensions	p bar	Pallet/ Pack	Box/M QTY	UOM	Price per m/each
1121532	1x3/4Euro	100 370 56 0,402	10	1	pce	111,28
1121533	2x3/4Euro	226 112 171 0,744	90	1	pce	211,87
1121534	3x3/4Euro	326 112 171 1,014	60	1	pce	302,40

Uponor Magna ball valve, set

- Made of brass



Item No.	Dimensions	L mm	W mm	H mm	W kg	Pallet/ Pack	Box/M QTY	UOM	Price per m/each
1030135	2x G 1 1/2	170	105	60	1,85	160	1	pce	163,15

Magna

Uponor Magna manifold bracket kit

- Includes:
- 2x brackets short
- 2x brackets long
- 1x mounting material: 8x screws 6x60mm, 8x plastic anchor, 8x40mm

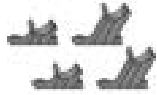

Item No.	L mm	W mm	H mm	W kg	Pallet/ Pack	Box/M QTY	UOM	Price per m/each
1045816	145	100	25	0,314	232	1	pce	27,24

Uponor Magna manifold bayonet segment

- Flow and Return as single segment
- Industrial Basic Kit and Uponor Bayonet Joint is necessary



Item No.	Dimensions	p bar	Pallet/ Pack	Box/M QTY	UOM	Price per m/each
1058340	11/2" 14m3/h	6	10	1	set	80,87

Uponor Magna manifold bayonet joint

- Made of brass
- For PE-Xa
- Item 1058341 is not compatible with item 1005403 and 1005420
- Item 1058342 is not compatible with item 1005404 and 1005421



Item No.	Dimensions	L mm	W mm	H mm	W kg	Pallet/ Pack	Box/M QTY	UOM	Price per m/each
1058341	32	80	40	40	1	10	1	set	107,44

Uponor Magna manifold flowmeter

- With shut-off function
- Made of fibreglass reinforced Polyamide



Item No.	L mm	W mm	H mm	W kg	Pallet/ Pack	Box/M QTY	UOM	Price per m/each
1030134	125	35	35	0,048	20	1	pce	18,99

Uponor Magna clamp track U-profile

- clamp track for pipes 20 / 25mm
- c-c 50mm



Item No.	Dimensions	c/c1 mm	l mm	do mm	b mm	Pallet/ Pack	Box/M QTY	UOM	Price per m/each
1005290	25mm c/c50mm	3m	50	3000	25 60	1320	30	m	7,22

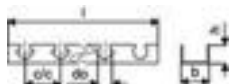

Magna











































Uponor Magna cabinet on-wall

- Zinc-coated
- Without backplane
- Made-to-order, non returnable delivery
- For use with Magna manifolds



Item No.	Dimensions	L mm	W mm	H mm	W kg	Pallet/ Pack	Box/M QTY	UOM	Price per m/each
1060553	1010x835x200mm	1010	200	835	18		1	pce	400,51
1060554	1910x835x200mm	1910	200	835	35		1	pce	581,71
1060555	2310x835x200mm	2310	200	835	42		1	pce	702,97

Compatible with:

Item No.	Dimension	Pallet/ Pack	Box/M QTY	UOM	Price per m/each
 1135496	Uponor Fix clamp track with adhesive 16-20mm c/c 50mm 1m	2000	100	pce	6,18
 1009230	Uponor Comfort Pipe PLUS 20x2,0 240m	960	240	m	4,18
 1009231	Uponor Comfort Pipe PLUS 20x2,0 480m	960	480	m	4,18
 1009232	Uponor Comfort Pipe PLUS 20x2,0 1000m		1000	m	4,09
 1062888	Uponor Comfort Pipe PLUS 25x2,3 220m	440	220	m	4,58
 1062889	Uponor Comfort Pipe PLUS 25x2,3 300m	600	300	m	4,67
 1063907	Uponor Comfort Pipe PLUS 25x2,3 640m		640	m	4,67
 1001220	Uponor Radi Pipe natural PN6 32x2,9 50m	550	50	m	14,45
 1008979	Uponor Radi Pipe natural PN6 40x3,7 50m	350	50	m	18,95
 1001245	Uponor Q&E elbow PPSU 32-32	10	1	pce	12,09
 1008683	Uponor Q&E elbow PPSU 40-40	10	1	pce	23,68
 1008932	Uponor Q&E coupling PPSU 20-20	80	5	pce	3,38
 1008671	Uponor Q&E coupling PPSU 25-25	50	5	pce	5,16
 1001235	Uponor Q&E coupling PPSU 32-32	15	1	pce	9,44
 1008673	Uponor Q&E coupling PPSU 40-40	10	1	pce	18,12
 1008676	Uponor Q&E reducer PPSU 25-20	40	5	pce	6,54
 1001240	Uponor Q&E reducer PPSU 32-25	20	1	pce	8,14
 1008678	Uponor Q&E reducer PPSU 40-32	10	1	pce	13,35
 1042867	Uponor Q&E reducer PPSU 50-40	10	1	pce	34,56
 1008686	Uponor Q&E tee PPSU 25-25-25	20	5	pce	8,45
 1001250	Uponor Q&E tee PPSU 32-32-32	10	1	pce	18,82
 1008688	Uponor Q&E tee PPSU 40-40-40	5	1	pce	30,44
 1008711	Uponor Q&E tee reducer PPSU 20-25-20	25	5	pce	8,53
 1008703	Uponor Q&E tee reducer PPSU 25-20-20	25	5	pce	8,53
 1008691	Uponor Q&E tee reducer PPSU 25-20-25	20	5	pce	7,84
 1001420	Uponor Q&E tee reducer PPSU 25-25-20	20	5	pce	9,80
 1008712	Uponor Q&E tee reducer PPSU 25-32-25	15	1	pce	14,75
 1001422	Uponor Q&E tee reducer PPSU 32-20-25	15	1	pce	13,70
 1001424	Uponor Q&E tee reducer PPSU 32-20-32	15	1	pce	14,68
 1008704	Uponor Q&E tee reducer PPSU 32-25-20	15	1	pce	14,27
 1001426	Uponor Q&E tee reducer PPSU 32-25-25	15	1	pce	14,94
 1001428	Uponor Q&E tee reducer PPSU 32-25-32	15	1	pce	16,17
 1008713	Uponor Q&E tee reducer PPSU 32-40-32	10	1	pce	24,45
 1008707	Uponor Q&E tee reducer PPSU 40-20-32	5	1	pce	23,31
 1008694	Uponor Q&E tee reducer PPSU 40-20-40	5	1	pce	23,46
 1008708	Uponor Q&E tee reducer PPSU 40-25-32	5	1	pce	23,72
 1008695	Uponor Q&E tee reducer PPSU 40-25-40	5	1	pce	25,20
 1008709	Uponor Q&E tee reducer PPSU 40-32-32	5	1	pce	25,01
 1008696	Uponor Q&E tee reducer PPSU 40-32-40	5	1	pce	27,03
 1057454	Uponor Q&E evolution ring white 20	520	20	pce	0,69
 1057455	Uponor Q&E evolution ring white 25	300	20	pce	0,81
 1057456	Uponor Q&E evolution ring white 32	150	10	pce	1,70
 1045464	Uponor Q&E ring with stop edge natural 40	80	5	pce	2,26
1141678	Uponor Vario PLUS actuator NC MT 230V 1W IP54	100	1	pce	50,65
1141679	Uponor Vario PLUS actuator NC MT 24V 1W IP54	100	1	pce	60,32
1065290	Uponor Vario compression adapter PEX 20x1,9/2,0-G3/4"FT Euro	25	1	pce	7,80
1065291	Uponor Vario compression adapter PEX 25x2,3-G3/4"FT Euro	25	1	pce	23,98
1009216	Uponor Vario PLUS valve tool	10	1	pce	6,46
1135492	Uponor Multi bend support plastic 20-22	140	35	pce	4,47
1063908	Uponor Q&E expansion tool with heads M18 6bar 16/20/25/32		1	set	852,89
1095324	Uponor Q&E expansion tool with heads M18 6bar 16/20/25/32 UK		1	set	897,60

Renovis



Benefits

- Architecturally deireable solution
- Quick and dry: professional installation time - approximately 3 rooms/day
- Highly efficient emitter system
- Energy efficient: low operating temperatures
- All-in-one solution: radiant heating/cooling and dry construction

Uponor Renovis for radiant heating and cooling consists of gypsum plasterboard into which Uponor PE-Xa pipes are pre-integrated ex-works.

Ideal for new-build and renovation, it enables thermal conditioning of rooms via walls and ceilings by use of dry build construction principal.

For professional installation, the Tichelmann principle with complete Uponor portfolio is recommended.

Specification

- Renovis prefab heating and cooling panel system, with embedded pipes 9.9mm.
- Based on 15mm fibre-reinforced gypsum panel
- Fire class E to BS EN 13501-1
- For mounting on defined dry-build sub constructions

Uponor Renovis panel

- Panel with embedded piping
- Active surface of Renovis system

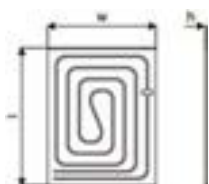

Application

- Ideal for new-build and renovation projects
- Radiant wall and ceiling heating and cooling
- For dry-build installations

Item No.	Dimensions	l mm	h mm	w mm	p bar	Pallet/ Pack	Box/M QTY	UOM	Price per m ² /each
1061173	800x625x15mm	800	15	625	6		24	pce	91,30
1061172	1200x625x15mm	1200	15	625	6		24	pce	112,09
1061171	2000x625x15mm	2000	15	625	6		24	pce	130,44

Renovis

Uponor Renovis panel extra

- Panel with embedded piping
- Active surface of Renovis system
- Single packed panel



Item No.	Dimensions	l mm	h mm	w mm	p bar	Pallet/ Pack	Box/M QTY	UOM	Price per m/each
1063923	800x625x15mm	800	15	625	6	24	1	pce	94,56
1063924	1200x625x15mm	1200	15	625	6	24	1	pce	108,40
1063925	2000x625x15mm	2000	15	625	6	24	1	pce	142,57



Uponor Renovis panel passive

- Passive panel without pipes

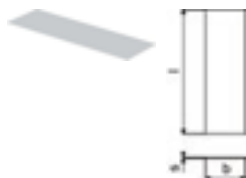

Item No.	Dimensions	l mm	s mm	b mm	Pallet/ Pack	Box/M QTY	UOM	Price per m/each
1063926	2000x625x15mm	2000	15	625		24	pce	40,09

Uponor Renovis component pack

- For jointing of Uponor Renovis Panels to the existing heating system
- Pack for max. 15 m² radiant heating area:
- For connection of 1 loop with 4 x 3 Renovis Panels (spread 10K) or
- For connection of 1 loop with 6 x 2 Renovis Panels (spread 5K)

- Consists on:

- 60 m Pipe PE-Xa 20x2,0 mm
- 15 pcs Rail 20 (L=250mm)
- 2 pcs Q&E Red- Coupling 20-9,9
- 10 pcs Q&E Coupling 9,9-9,9
- 15 pcs Q&E Tee 20-9,9-20
- 2 pcs Manifold connection 20-G3/4



Item No.	Dimensions	L mm	W mm	H mm	W kg	Pallet/ Pack	Box/M QTY	UOM	Price per m/each
1061165	4-6x	1000	21	21	8,8	10	1	set	450,35





























Uponor Renovis clamp track

- Clamp track for pipes 9.9mm
- Centres c-c 50mm
- With self-adhesive fixing



Item No.	Dimensions	c/c mm	l mm	do mm	b mm	h mm	Pallet/ Pack	Box/M QTY	UOM	Price per m/each
1061162	20mm l=250mm	50	250	20	40	26		15	pce	2,72

Compatible with:

Item No.	Dimension	Pallet/ Pack	Box/M QTY	UOM	Price per m/each
 1005274	Uponor Fix clamp track 9,9mm c/c20mm 2,5m	25	2,50	m	2,22
 1063287	Uponor Comfort Pipe Minitec 9,9x1,1 60m	840	60	m	2,03
 1063288	Uponor Comfort Pipe Minitec 9,9x1,1 120m	1680	120	m	2,03
 1063289	Uponor Comfort Pipe Minitec 9,9x1,1 240m	2640	240	m	2,03
 1063381	Uponor Comfort Pipe Minitec 9,9x1,1 480m	2880	480	m	2,03
 1005265	Uponor Minitec adapter male thread, ring 9,9-R1/2"MT	100	10	pce	6,26
 1005264	Uponor Minitec coupling, rings 9,9x1,1	100	10	pce	7,34
 1005263	Uponor Minitec ring natural 9,9x1,1	1600	10	pce	0,61
 1009230	Uponor Comfort Pipe PLUS 20x2,0 240m	960	240	m	4,18
 1009231	Uponor Comfort Pipe PLUS 20x2,0 480m	960	480	m	4,18
 1009229	Uponor Comfort Pipe PLUS 20x2,0 60m	660	60	m	4,18
 1009228	Uponor Comfort Pipe PLUS 20x2,0 120m	840	120	m	4,18
 1020543	Uponor Comfort Pipe PLUS insulated 13mm 20x2,0 60m	480	60	m	7,72
 1020524	Uponor Q&E tee reduced, rings Minitec 20xMinitec9,9xQ&E20	75	5	pce	11,37
 1020518	Uponor Q&E reducer, rings Minitec 20xMinitec9,9	150	5	pce	8,08
 1008932	Uponor Q&E coupling PPSU 20-20	80	5	pce	3,38
 1057454	Uponor Q&E evolution ring white 20	520	20	pce	0,69
 1060784	Uponor Uni Pipe PLUS white S 20x2,25 3m	51	3	m	7,10
 1065290	Uponor Vario compression adapter PEX 20x1,9/2,0-G3/4"FT Euro	25	1	pce	7,80
 1005107	Uponor Vario supply valve 1/2" - G3/4	50	1	pce	39,94
 1005108	Uponor Vario return valve 1/2" - G3/4	50	1	pce	38,92
 1141678	Uponor Vario PLUS actuator NC MT 230V 1W IP54	100	1	pce	50,65
 1141679	Uponor Vario PLUS actuator NC MT 24V 1W IP54	100	1	pce	60,32
 1058422	Uponor Base thermostat T-23 standard 230V RAL9010	160	1	pce	86,10
 1006247	Uponor Minitec expansion tool 9,9x1,1	11	1	set	201,55
 1006250	Uponor Minitec expansion head 9,9x1,1		1	pce	69,36
 1119380	Uponor Q&E expansion head M12/Rapid Seal 9,9x1,1		1	pce	68,88
 1135490	Uponor Multi bend support plastic 10-12	360	60	pce	2,08
 1135491	Uponor Multi bend support plastic 14-18	240	30	pce	3,00

Siccus Mini

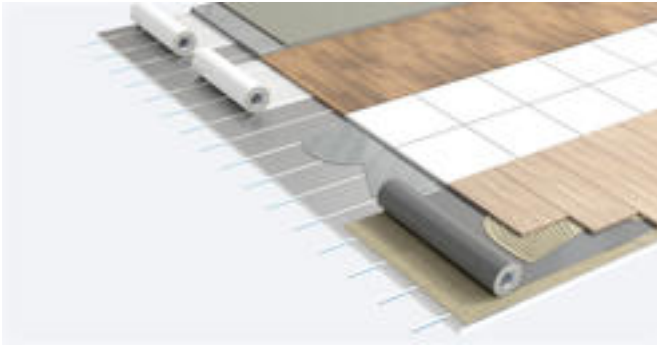

Benefits

- Fast reaction - heating/cooling
- Very low build height
- Floor coverings can be applied directly onto the surface
- Short and simple installation time through immediate accessibility and no other craftsmen needed
- The system is optimally suitable for energy-efficient low-temperature use
- Low flooring structure to perfectly fit to residential renovation needs

Siccus Mini is a next-generation low build height underfloor heating/cooling system designed for fast installation, with the added benefit of the floor coverings being directly applied onto the panel without the need for overboarding.

Direct Flooring Technology Supports laminate, wood and tile flooring directly on the EPS panel, a unique feature compared to competitors

A low build height solution that means that doorways, kitchen work surfaces and light switches do not need to be raised.

Specification

- Siccus Mini is a low-profile, dry installation UFH system
- Full-surface integrated, aluminium heat conducting layer according to BS EN 1264; design B
- For installation with Uponor Comfort PE-X Pipe 9.9mm

Application

- Radiant underfloor heating and cooling for dry-build installations
- Direct floor application

Certification

- Certification Siccus mini
- DINCERTCO 7F531-F (floating laminate)
 - DINCERTCO 7F532-F (direct flooring with wood parquet)
 - DINCERTCO 7F533-F (direct flooring with ceramic tiles, natural stone)
 - DINCERTCO 7F534-F (gypsum fiber layer for vinyl and carpet)

Uponor Siccus Mini Panel

- EPS panel 1.200x600x15mm
- With full-face heat transfer layer of Aluminium
- With integrated pipe grooves c-c 100mm
- For use with Uponor Comfort Pipe Minitec 9,9

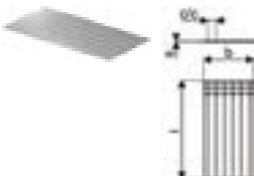

Item No.	In/Out	Dimensions	b mm	h mm	Pallet/ Pack	Box/M QTY	UOM	Price per m/each
1161845	03.26	1200x600x15mm	600	15	100.8	7,20	m ²	54,63
1161847	03.26	1200x600x15mm 7,2M2	600	15	14	1	set	39,41

Siccus Mini

Uponor Siccus Mini Panel Blank

- EPS panel 1.200x600x15mm
- Without heat transfer layer of Aluminium

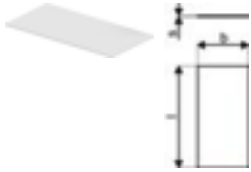

Item No.	In/Out	Dimensions	b mm	h mm	Pallet/ Pack	Box/M QTY	UOM	Price per m/each
1161846	03.26	1200x600x15mm	600	15	86.4	2,88	m ²	393,25
1161848	03.26	1200x600x15mm 2,88M2	600	15	30	1	set	113,54

Uponor Siccus Mini hotcutter tool

































- hot cutting tool 230V with cutting insert to cut grooves for 9.9mm pipes inside Siccus Mini panels



Item No.	Dimensions	L mm	W mm	H mm	W kg	Pallet/ Pack	Box/M QTY	UOM	Price per m/each
1139796	10mm 230V	250	70	50	1,05	20	1	pce	227,25

Siccus Mini

Compatible with:

Item No.	Dimension	Pallet/ Pack	Box/M QTY	UOM	Price per m/each
 1020183	Uponor Minitec edging strip, self-adh. 20m 80x8mm		20	m	1,33
 1005267	Uponor Minitec edging strip, self-adh. 20m 80x8mm		200	m	1,49
 1085980	Uponor Minitec expansion joint profile 0,9m 40x10mm	600	10	pce	7,34
 1085981	Uponor Minitec expansion joint profile 1,3m 40x10mm	600	10	pce	9,04
 1005049	Uponor Multi foil PE 0,2mm 60x1,25m	3375	75	m ²	1,53
 1063288	Uponor Comfort Pipe Minitec 9,9x1,1 120m	1680	120	m	2,03
 1063289	Uponor Comfort Pipe Minitec 9,9x1,1 240m	2640	240	m	2,03
 1063381	Uponor Comfort Pipe Minitec 9,9x1,1 480m	2880	480	m	2,03
 1005266	Uponor Minitec adapter 9,9x1,1-G3/4"Euro	100	10	pce	11,76
 1005264	Uponor Minitec coupling, rings 9,9x1,1	100	10	pce	7,34
 1005265	Uponor Minitec adapter male thread, ring 9,9-R1/2"MT	100	10	pce	6,26
 1005263	Uponor Minitec ring natural 9,9x1,1	1600	10	pce	0,61
 1013426	Uponor Minitec compression adapter fem 9,9-3/4"Euro	120	12	pce	8,46
 1016690	Uponor Minitec compression coupling 9,9-9,9	48	12	pce	20,83
 1016691	Uponor Minitec compression adapter male 9,9-R1/2"MT	120	12	pce	21,29
 1016692	Uponor Minitec Y compression adapter 2x9,9-3/4"Euro		50	pce	35,78
 1005675	Uponor Fluvia Y compression adapter 2xG3/4-3/4"Euro	50	1	set	48,25
 1095127	Uponor Fluvia T pumpgroup Push-12 TH-G	60	1	pce	795,55
 1095131	Uponor Fluvia T pumpgroup Push-12 CH-G	30	1	pce	1 335,27
 1095128	Uponor Fluvia T pumpgroup Push-12 AC-G	60	1	pce	636,92
 1061802	Uponor Vario fill and drain valve 3/4" - 3/4"	10	1	set	46,36
 1135490	Uponor Multi bend support plastic 10-12	360	60	pce	2,08
 1005270	Uponor Minitec connection box 1x	30	1	pce	438,46
 1005271	Uponor Minitec connection box 2x		1	pce	585,18
 1005272	Uponor Minitec connection box 3x		1	pce	663,77
 1007251	Uponor Minitec connection box cover		1	pce	119,35
 1058422	Uponor Base thermostat T-23 standard 230V RAL9010	160	1	pce	86,10
 1141678	Uponor Vario PLUS actuator NC MT 230V 1W IP54	100	1	pce	50,65
 1141679	Uponor Vario PLUS actuator NC MT 24V 1W IP54	100	1	pce	60,32
 1006247	Uponor Minitec expansion tool 9,9x1,1	11	1	set	201,55
 1006250	Uponor Minitec expansion head 9,9x1,1		1	pce	69,36
 1119380	Uponor Q&E expansion head M12/Rapid Seal 9,9x1,1		1	pce	68,88

Siccus 16



Benefits

- Fast Installation: Quick setup with minimal steps, reducing installation time and costs
- Direct Flooring Technology Supports laminate, wood, and tile flooring directly on the EPS panel,
- Energy Efficiency Optimized heat distribution with a 20-minute reaction time
- Energy efficient
- Low Construction Height Only 20mm thick
- Suitable for Renovation Projects Lightweight and requires minimal disruption to the building

Siccus 16 is a next-generation underfloor heating/cooling system designed for fast installation, with the added benefit of the floor coverings being directly applied onto the panel.

Direct Flooring Technology Supports laminate, wood and tile flooring directly on the EPS panel, a unique feature compared to competitors

A fast 20 minute reaction time ensures an energy efficient solution for both new build and renovation projects.

A low build height solution that means that doorways, kitchen work surfaces and light switches do not need to be raised.

Specification

- Siccus 16 underfloor heating panel system, consists of EPS (HBCD-free) boards acc. EN 13163 with Aluminium foil.
- Fire class E to BS EN 13501-1
- Application type acc. DIN 4108-10: DE0
- life load acc. EN 1991-1-1 = 2,0 kN/m²
- for installations with pipe c-c 150mm
- for pipe dim 16mm

Certification

- DIN CERTCO

Uponor Siccus 16 panel EPS DE0

- Installation with full-face heat transfer layer of Aluminium
- With integrated pipe grooves c-c 150mm
- EPS compressive strength: 400 kPa

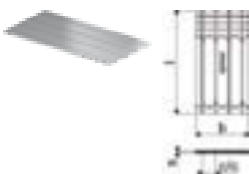

Item No.	In/Out	Dimensions	l mm	b mm	s mm	Pallet/ Pack	Box/M QTY	UOM	Price per m ² /each
1143475	01.25	1200x600x20mm	1200	600	20	72	7,20	m ²	58,24

Siccus 16

Uponor Siccus 16 Panel

- Installation with full-face heat transfer layer of Aluminium
- With integrated pipe grooves c-c 150mm
- EPS compressive strength: 400kPA

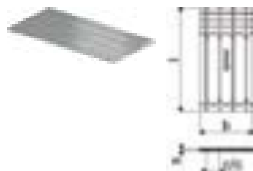

Item No.	In/Out	Dimensions	b mm	h mm	Pallet/ Pack	Box/M QTY	UOM	Price per m/each
1161884	NEW	1200x600x20mm, 7,2M2	600	20	10	1	set	290,10

Uponor Siccus 16 Panel Blank

- Installation panel without heat transfer layer of Aluminium

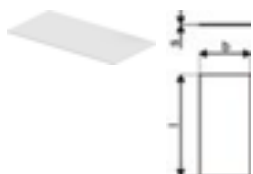

Item No.	In/Out	Dimensions	b mm	h mm	Pallet/ Pack	Box/M QTY	UOM	Price per m/each
1161882	NEW	1200x600x20mm	600	20	69,12	2,88	m ²	26,67
1161883	NEW	1200x600x20mm, 2,88M2	600	20	24	1	set	76,77

Uponor Siccus 16 edge support

- Mandatory edge support for installation with flooring of ceramic tiles and natural stone
- Edge support against wall sides and in door ways

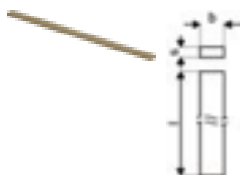

Item No.	In/Out	Dimensions	l mm	b mm	s mm	Pallet/ Pack	Box/M QTY	UOM	Price per m/each
1143476	NEW	1000x45x19mm	1000	45	19	720	10	m	9,59

Uponor Siccus 16 PS cutter head

- for PS cutter tool, for EPS/XPS



Item No.	Dimensions	L mm	W mm	H mm	W kg	Pallet/ Pack	Box/M QTY	UOM	Price per m/each
1144842	16mm	85	16	16	0,047		1	pce	94,15

Compatible with:

Item No.	Dimension	Pallet/ Pack	Box/M QTY	UOM	Price per m/each
1084207	Uponor Multi insulation panel XPS 400 20X600X1250mm		15,75	m ²	13,48
1005049	Uponor Multi foil PE 0,2mm 60x1,25m	3375	75	m ²	1,53
1065284	Uponor Vario compression adapter PEX 16x1,8/2,0-G3/4"FT Euro	25	1	pce	11,10
1058090	Uponor Uni-X compression adapter MLC 16-3/4"FT Euro	25	1	pce	6,69
1070547	Uponor S-Press PLUS coupling 16-16	80	20	pce	8,86
1039933	Uponor S-Press PLUS coupling PPSU 16-16	80	20	pce	5,47
1000079	Uponor Multi PE edging strip with foil 150x8mm		200	m	1,68
1135494	Uponor Multi PE edging strip with foil HB 150x8mm		250	m	1,63
1135491	Uponor Multi bend support plastic 14-18	240	30	pce	3,00
1085980	Uponor Minitec expansion joint profile 0,9m 40x10mm	600	10	pce	7,34
1085981	Uponor Minitec expansion joint profile 1,3m 40x10mm	600	10	pce	9,04

Tacker

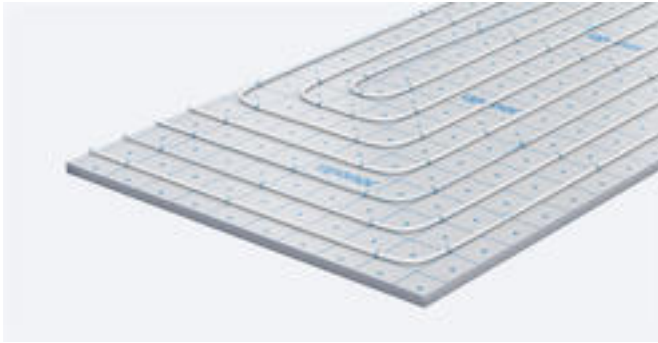

Benefits

- Suitable for all types of screeds
- Fast to install: integrated insulation layer and cover
- Universal pipe clips for pipe thickness 14 – 20mm
- Easy installation: ergonomically designed stapler

All components of the Uponor Tacker system are designed to perfectly match each other. They enable easy installation of system pipes. All components are designed to ensure optimum safety and reliable operation.

Specification

-

Application

- Radiant underfloor heating and cooling
- For use with cement- and anhydrite-based screeds

Certification

- DIN CERTCO: 7F077-F, 7F185-F, 7F216-F, 7F278-F

Uponor Tacker pipe clip short set = 300pce

- Tacker fixation clip
- For use with Uponor Tacker clip stapler

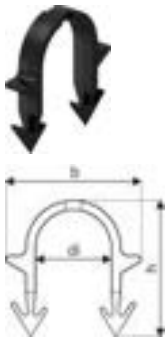

Item No.	Dimensions	di mm	b mm	h mm	Pallet/ Pack	Box/M QTY	UOM	Price per m/each
1140123	14-17mm h=35mm	20	36	36	28	1	set	34,32

Uponor Tacker pipe clip standard set = 1000pce

- Tacker fixation clip
- For use with Uponor Tacker clip stapler

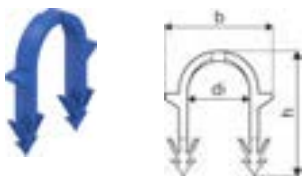

Item No.	Dimensions	di mm	b mm	h mm	Pallet/ Pack	Box/M QTY	UOM	Price per m/each
1140159	14-20mm h=40mm	19	38	40	8	1	set	114,40

Uponor Tacker pipe clip XL set = 300pce

- Tacker fixation clip
- For use with Uponor Tacker clip stapler

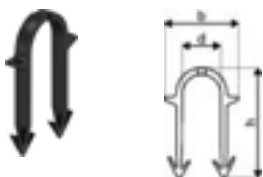

Item No.	In/Out	Dimensions	L mm	W mm	H mm	W kg	Pallet/ Pack	Box/M QTY	UOM	Price per m/each
1161223	03.26	14-20mm h=57mm	170	205	115	0,63	20	1	set	13,11

Classic

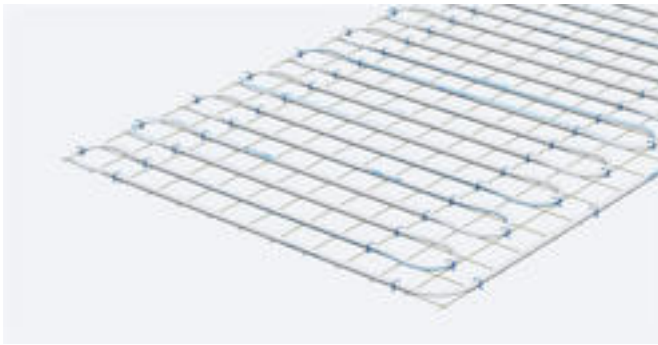

Benefits

- Cost efficient: flexible, fast and easy to install
- Flexible: choice of insulation material
- Security: no damage to insulation covering
- Reliable: long-term, proven system

Uponor Classic is the ideal solution for underfloor heating/cooling systems in new residential and commercial buildings. Available in three grid sizes, it enables optimisation of pipe spacing to meet heating needs. Combined with high-payload insulation, it is also suited for areas such as garage showrooms, production halls, retail outlets, etc.

Specification

- Classic underfloor heating system for installation on top of thermal/step-sound insulation provided by the customer.
- Designed as steel-mesh supported fixation using single pipe clips

Application

- Radiant underfloor heating and cooling
- For use with cement- and anhydrite-based screeds

Certification

- DIN CERTCO: 7F004-F; 7F371-F; 7F421-F

Uponor Classic steel mesh, coated

- Steel mesh for mounting of pipe fixing of underfloor heating pipes
- Material: coated steel

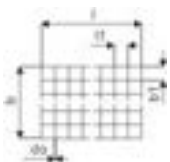

Item No.	Dimensions	l1 mm	l mm	do mm	b mm	b1 mm	Pallet/ Pack	Box/M QTY	UOM	Price per m ² /each
1005084	100mm 2100x1200x3mm	100	2100	3	1200	100	756	25,20	m ²	8,27
1005087	150mm 2100x1200x3mm	150	2100	3	1200	150	756	25,20	m ²	5,91

Uponor Classic steel mesh

- steel mesh for mounting of pipe fixing of underfloor heating pipes
- material: coated steel

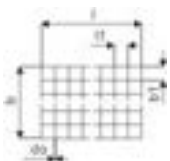

Item No.	Dimensions	l1 mm	l mm	do mm	b mm	b1 mm	Pallet/ Pack	Box/M QTY	UOM	Price per m ² /each
1063406	100mm 2100x1200x3mm	100	2100	3	1200	100	25.2	2,52	m ²	7,57
1063407	150mm 2100x1200x3mm	150	2100	3	1200	150	25.2	2,52	m ²	5,30

Classic























Uponor Classic tying wire, steel, coated

- Galvanized steel wire usable to fix pipe to steel mesh
- For use with Uponor tool for metallic clip
- Protected against corrosion



Item No.	Dimensions	L mm	W mm	H mm	W kg	Pallet/ Pack	Box/M QTY	UOM	Price per m/each
1007393	80mm (100pce/set)	190	90	20	0,11	2500	50	set	4,47

Compatible with:

Item No.	Dimension	Pallet/ Pack	Box/M QTY	UOM	Price per m/each
 1000079	Uponor Multi PE edging strip with foil 150x8mm		200	m	1,68
 1000080	Uponor Multi PE edging strip with foil 150x10mm		200	m	1,84
 1135493	Uponor Multi PE edging strip with foil 130x8mm		400	m	1,63
 1135494	Uponor Multi PE edging strip with foil HB 150x8mm		250	m	1,63
 1090229	Uponor Multi expansion joint profile 1800x100x10mm	720	18	m	7,36
 1000082	Uponor Multi joint protection tube 20mm 300x5mm	1800	30	pce	1,04
 1062044	Uponor Comfort Pipe PLUS 16x2,0 120m	1080	120	m	1,93
 1062045	Uponor Comfort Pipe PLUS 16x2,0 240m	1440	240	m	1,93
 1062046	Uponor Comfort Pipe PLUS 16x2,0 640m	1280	640	m	1,93
 1009228	Uponor Comfort Pipe PLUS 20x2,0 120m	840	120	m	4,18
 1009230	Uponor Comfort Pipe PLUS 20x2,0 240m	960	240	m	4,18
 1009231	Uponor Comfort Pipe PLUS 20x2,0 480m	960	480	m	4,18
 1009232	Uponor Comfort Pipe PLUS 20x2,0 1000m		1000	m	4,09
 1065284	Uponor Vario compression adapter PEX 16x1,8/2,0-G3/4"FT Euro	25	1	pce	11,10
 1065290	Uponor Vario compression adapter PEX 20x1,9/2,0-G3/4"FT Euro	25	1	pce	7,80
 1057454	Uponor Q&E evolution ring white 20	520	20	pce	0,69
 1086575	Uponor Smart UFH-pipe 16x2,0 240m	1440	240	m	1,72
 1086576	Uponor Smart UFH-pipe 16x2,0 640m	1280	640	m	1,78
 1086577	Uponor Smart UFH-pipe 20x2,0 240m	960	240	m	2,60
 1086578	Uponor Smart UFH-pipe 20x2,0 480m	960	480	m	2,60
 1135491	Uponor Multi bend support plastic 14-18	240	30	pce	3,00
 1135492	Uponor Multi bend support plastic 20-22	140	35	pce	4,47

Minitec

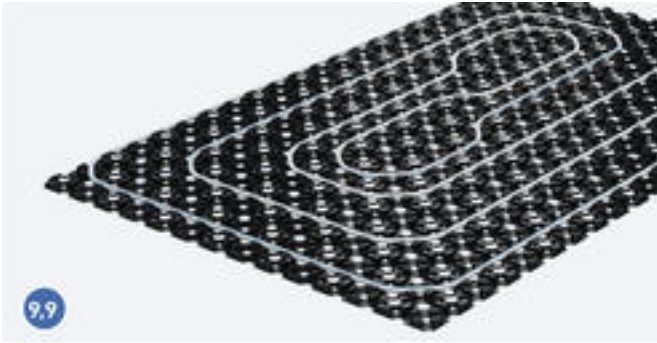

Benefits

- Low build height: ideal for new-build or renovation projects
- No need to raise doorway head jambs or kitchen work units
- Easy: fast, efficient installation by one technician
- For use with fast drying self-levelling screeds
- Ready for foot traffic within a day
- Comfort: short heat-up times, fast temperature control response
- Self-adhesive panels for simple layout
- Low operating temperatures; ideal for low-carbon heat technologies

Uponor Minitec is the low-build height solution for underfloor heating on existing screed, timber, or tiled floors.

With a low installation height of only 15mm the system consists of a self-adhesive castellated panel and PE-Xa pipe 9.9mm.

Minitec is optimised for near-surface heating in residential buildings.

Specification

- Minitec underfloor heating system for fixation on solid floors or specified insulation materials
- Designed as sturdy pipe fixing system of minimum height, with integrated pipe laying channels for correct pipe laying distances
- For use with Uponor Minitec PE-Xa pipes 9.9 x 1.1 mm; allowing for straight and diagonal pipe laying
- Fire class E to BS EN 13501-1 (pipe and panels)
- Pipe spacing: Vz 5, 10, 15
- Net surface with overlapping nubs: 0,77m²

Application

- Radiant underfloor heating and cooling
- Very low construction height
- For use with qualified filler materials

Certification

- DIN CERTCO: 7F170-F

Uponor Minitec nubfoil self-adh

- Pipe fixation panel made of polystyrol
- With overlap on both sides with triangular location studs
- Perforated panel to allow levelling compound to encapsulate the whole assembly even onto the substructure below the panel
- With self-adhesive back for proper fixture to screed and tiled floors.



Item No.	Dimensions	L mm	W mm	H mm	W kg	Pallet/ Pack	Box/M QTY	UOM	Price per m ² /each
1047318	6,2m ² 9,9x1,1 1100x700x12mm	1120	720	12	0,968	99.2	6,20	m ²	27,67
1083866	8pce, 6,2m ² 1100x700x12mm	1115	715	15	6,16	16	1	set	183,28
1005261	15,4m ² 9,9x1,1 1100x700x12mm	1100	700	12	0,968	123.2	15,40	m ²	25,68

Minitec

Uponor Minitec edging strip, self-adh.

- Edging strip for Minitec system, conforming to DIN 18560
- Made of polyethylene with self-adhesive backing
- Self-adhesive strip on outer face provides tight seal between edging strip and insulation.



Item No.	Dimensions	l mm	s mm	b mm	Pallet/ Pack	Box/M QTY	UOM	Price per m/each
1020183	20m 80x8mm	20000	8	80		20	m	1,33
1005267	20m 80x8mm	20000	8	80		200	m	1,49

Uponor Minitec expansion joint profile

- Self-adhesive profile of polyethylene foam expansion strip and hard-PVC body
- For separation of screed sections (e.g. in doorways), and to absorb expansion of screed.
- For expansion joints as per DIN 18560-2.



Item No.	Dimensions	l mm	s mm	b mm	h mm	Pallet/ Pack	Box/M QTY	UOM	Price per m/each
1085980	0,9m 40x10mm	900	10	50	40	600	10	pce	7,34
1085981	1,3m 40x10mm	1300	10	50	40	600	10	pce	9,04



Uponor Minitec joint protection tube

- Made of PE-LD, with slit opening
- For protection of UFH pipes up to 9.9 mm in areas of expansion joints.



Item No.	Dimensions	s mm	Pallet/ Pack	Box/M QTY	UOM	Price per m/each
1005269	9,9mm 300x2mm	2,0	3600	30	pce	1,62

Uponor Minitec adapter

- Eurocone
- Brass

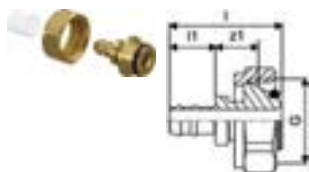

Item No.	Dimensions	G inch	l1 mm	l mm	z1 mm	Pallet/ Pack	Box/M QTY	UOM	Price per m/each
1005266	9,9x1,1-G3/4" Euro	0,75	14,4	35,4	13,5	100	10	pce	11,76

Uponor Minitec coupling, rings

- Q&E
- Made of Brass
- With Q&E rings



Item No.	Dimensions	l1 mm	l2 mm	l mm	s mm	z1 mm	p bar	Pallet/ Pack	Box/M QTY	UOM	Price per m/each
1005264	9,9x1,1	14,4	14,4	32,8	1,1	4	6	100	10	pce	7,34

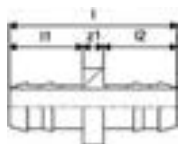

Uponor Minitec adapter male thread, ring

- Q&E
- Made of Brass
- With Q&E rings



Item No.	Dimensions	l1 mm	l2 mm	l mm	R inch	z1 mm	p bar	Pallet/ Pack	Box/M QTY	UOM	Price per m/each
1005265	9,9-R1/2"MT	16	14	38	1/2	8	6	100	10	pce	6,26

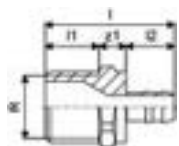

Uponor Minitec ring natural

- PE-Xa

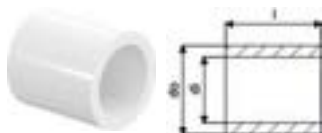

Item No.	Dimensions	di mm	l mm	do mm	p bar	Pallet/ Pack	Box/M QTY	UOM	Price per m/each
1005263	9,9x1,1	10,3	15	13,9	6	1600	10	pce	0,61

Uponor Minitec compression adapter fem

- Made of brass
- 3/4 Eurocone



Item No.	Dimensions	G inch	l1 mm	l mm	z1 mm	Pallet/ Pack	Box/M QTY	UOM	Price per m/each
1013426	9,9-3/4" Euro	3/4	18	25,6	1	120	12	pce	8,46

Uponor Minitec compression coupling

- Made of brass
- Screw



Item No.	Dimensions	l1 mm	l2 mm	l mm	z1 mm	Pallet/ Pack	Box/M QTY	UOM	Price per m/each
1016690	9,9-9,9	15	15	46	16	48	12	pce	20,83

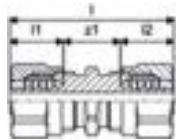

Uponor Minitec compression adapter male

- Made of brass
- Screw



Item No.	Dimensions	l1 mm	l2 mm	l mm	R inch	z1 mm	Pallet/ Pack	Box/M QTY	UOM	Price per m/each
1016691	9,9-R1/2"MT	12,5	15	37,5	1/2	10	120	12	pce	21,29

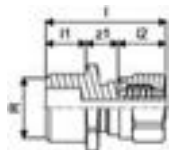

Uponor Minitec Y compression adapter

- Made of brass
- 3/4 Eurocone
- For 2 loops

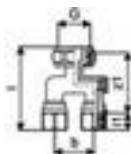

Item No.	Dimensions	G inch	l1 mm	l mm	b mm	z1 mm	Pallet/ Pack	Box/M QTY	UOM	Price per m/each
1016692	2x9,9-3/4"Euro	3/4	13	63,5	30	46		50	pce	35,78

Uponor Minitec connection box

- For single room temperature control
- Primary circuit connection 3/4" Eurocone
- Max. pressure: 10 bar at 60°C



Item No.	Dimensions	p bar	Pallet/ Pack	Box/M QTY	UOM	Price per m/each
1005270	1x	10	30	1	pce	438,46
1005271	2x	10		1	pce	585,18
1005272	3x	10		1	pce	663,77



















Uponor Minitec connection box cover

- Stainless steel, high polished
- Only for the Minitec connection boxes
- 4 screws



Item No.	L mm	W mm	H mm	W kg	Pallet/ Pack	Box/M QTY	UOM	Price per m/each
1007251	312	238	2	0,71		1	pce	119,35

Compatible with:

Item No.	Dimension	Pallet/ Pack	Box/M QTY	UOM	Price per m/each
 1005274	Uponor Fix clamp track 9,9mm c/c20mm 2,5m	25	2,50	m	2,22
 1084161	Uponor Multi insulation panel XPS 400 10X600X1250mm	360	30	m ²	7,91
 1084207	Uponor Multi insulation panel XPS 400 20X600X1250mm		15,75	m ²	13,48
 1063287	Uponor Comfort Pipe Minitec 9,9x1,1 60m	840	60	m	2,03
 1063288	Uponor Comfort Pipe Minitec 9,9x1,1 120m	1680	120	m	2,03
 1063289	Uponor Comfort Pipe Minitec 9,9x1,1 240m	2640	240	m	2,03
 1063381	Uponor Comfort Pipe Minitec 9,9x1,1 480m	2880	480	m	2,03
 1005675	Uponor Fluvia Y compression adapter 2xG3/4-3/4" Euro	50	1	set	48,25
 1095127	Uponor Fluvia T pumpgroup Push-12 TH-G	60	1	pce	795,55
 1095131	Uponor Fluvia T pumpgroup Push-12 CH-G	30	1	pce	1 335,27
 1095128	Uponor Fluvia T pumpgroup Push-12 AC-G	60	1	pce	636,92
 1061802	Uponor Vario fill and drain valve 3/4" - 3/4"	10	1	set	46,36
 1135490	Uponor Multi bend support plastic 10-12	360	60	pce	2,08
 1058422	Uponor Base thermostat T-23 standard 230V RAL9010	160	1	pce	86,10
 1141680	Uponor Vario retrofit actuator NC FT 230V 1W IP54	100	1	pce	44,63
 1141681	Uponor Vario retrofit actuator NC FT 24V 1W IP54	100	1	pce	43,36
 1141676	Uponor Vario actuator NC FT 230V 1W IP54	100	1	pce	47,58
 1141677	Uponor Vario actuator NC FT 24V 1W IP54	100	1	pce	46,10
 1119380	Uponor Q&E expansion head M12/Rapid Seal 9,9x1.1		1	pce	68,88

Nubos

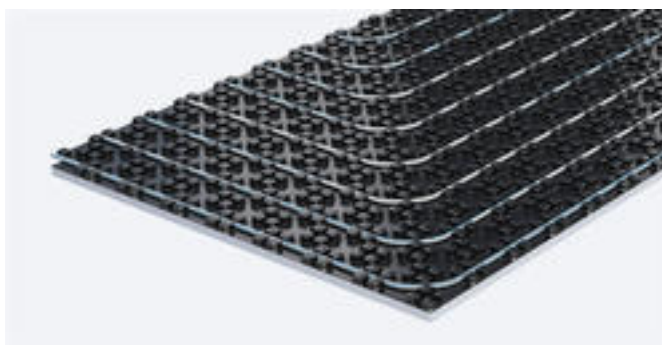

Benefits

- Easy: very few, optimally matched system components
- Choose between multilayer composite pipe or PE-Xa pipe (DIM 14/16)
- Ideal for use with low-carbon heat sources

Uponor Nubos is specially designed for underfloor heating/cooling systems in residential and non-residential buildings.

The panels are installed in the floor below the cement or anhydrite screed load distribution layer. They are available in three different thicknesses (ND 30-2, ND 11 and Nubfoil without insulation) for various floor constructions and load-bearing requirements.

Specification

- Nubos nub panel underfloor heating system, consists of nub panels for use with pipe dimensions 14-16mm.
- Pipe spacing in cm: 5,5, 11, 16,5, 22, 27,5 33
- Fire class E to BS EN 13501-1
- EPS quality according EN 13163

Application

- Radiant underfloor heating and cooling
- For use with cement- and anhydrite-based screeds

Certification

- DIN CERTCO: 7F335-F, 7F336-F, 7F337-F, 7F338-F

Uponor Nubos foil

- Pipe fixation panel for installation on existing insulation



Item No.	Dimensions	L mm	W mm	H mm	W kg	Pallet/ Pack	Box/M QTY	UOM	Price per m/each
1016703	14-16mm	1447	900	18	0,72	140	10	m ²	19,81

























Uponor Nubos set

- EPS (HBCD free) thermal insulation panel



Item No.	Dimensions	L mm	W mm	H mm	W kg	G kN/m ²	Pallet/ Pack	Box/M QTY	UOM	Price per m/
1016701	EPS 30-2 14-16mm	1447x900x48mm	1447	900	65	3,2 5	50	5	m ²	20,65
1016702	EPS 11 14-16mm	1447x900x29mm	1000	1000	15	1,2 30	50	5	m ²	13,39

Compatible with:

Item No.	Dimension	Pallet/ Pack	Box/M QTY	UOM	Price per m/each
 1000079	Uponor Multi PE edging strip with foil 150x8mm		200	m	1,68
 1000080	Uponor Multi PE edging strip with foil 150x10mm		200	m	1,84
 1135493	Uponor Multi PE edging strip with foil 130x8mm		400	m	1,63
 1135494	Uponor Multi PE edging strip with foil HB 150x8mm		250	m	1,63
 1090229	Uponor Multi expansion joint profile 1800x100x10mm	720	18	m	7,36
 1000082	Uponor Multi joint protection tube 20mm 300x5mm	1800	30	pce	1,04
 1135496	Uponor Fix clamp track with adhesive 16-20mm c/c 50mm 1m	2000	100	pce	6,18
 1062883	Uponor Comfort Pipe PLUS 14x2,0 120m	1320	120	m	1,88
 1062884	Uponor Comfort Pipe PLUS 14x2,0 240m	1680	240	m	1,84
 1062885	Uponor Comfort Pipe PLUS 14x2,0 960m	1920	960	m	1,66
 1062044	Uponor Comfort Pipe PLUS 16x2,0 120m	1080	120	m	1,93
 1062045	Uponor Comfort Pipe PLUS 16x2,0 240m	1440	240	m	1,93
 1062046	Uponor Comfort Pipe PLUS 16x2,0 640m	1280	640	m	1,93
 1065284	Uponor Vario compression adapter PEX 16x1,8/2,0-G3/4"FT Euro	25	1	pce	11,10
 1005675	Uponor Fluvia Y compression adapter 2xG3/4-3/4" Euro	50	1	set	48,25
 1086575	Uponor Smart UFH-pipe 16x2,0 240m	1440	240	m	1,72
 1086576	Uponor Smart UFH-pipe 16x2,0 640m	1280	640	m	1,78
 1013366	Uponor Uni Pipe PLUS white 14x2,0 200m	2600	200	m	3,06
 1058089	Uponor Uni-X compression adapter MLC 14-3/4"FT Euro	25	1	pce	8,92
 1058090	Uponor Uni-X compression adapter MLC 16-3/4"FT Euro	25	1	pce	6,69
 1070547	Uponor S-Press PLUS coupling 16-16	80	20	pce	8,86
 1015154	Uponor S-Press coupling 14-14	80	10	pce	8,24
 1039933	Uponor S-Press PLUS coupling PPSU 16-16	80	20	pce	5,47
 1135491	Uponor Multi bend support plastic 14-18	240	30	pce	3,00

Comfort Pipe PLUS



Benefits

- High durability and proven long service life
- Reliable oxygen diffusion resistance for long-term system protection
- Suitable for low-temperature and energy-efficient heating and cooling systems
- Flexible installation with a wide range of dimensions
- Compatible with Uponor radiant heating and cooling solutions

Uponor Comfort Pipe PLUS is a PE-Xa radiant pipe designed for heating and cooling applications. It features a five-layer construction with an oxygen diffusion barrier and is optimized for long-term performance in water-based radiant systems.

Application

- Underfloor heating and low temperature radiators
- Heating
- Max design temperature: 80°C
- Malfunction temperature 100°C
- Design pressure 6 Bar at 70°C

Specification

- Pipes manufactured from peroxide cross-linked polyethylene (PE-Xa) acc. BS EN ISO 15875
- EVOH (ethylene vinyl alcohol) layer for oxygen diffusion resistance as per DIN 4726
- 5layer
- Outside white PE layer designed to protect against mechanical damages
- Application class 4/5 - Underfloor heating and low temperature radiators
- Fire class E according to BS EN 13501-1.

Uponor Comfort Pipe PLUS

- UFH pipe made of PE-Xa
- Complying with ISO 22391 and fulfils oxygen diffusion resistance as per DIN 4726
- Application class 4 and 5
- Design pressure 6 Bar at 70°C

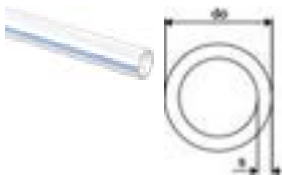

Item No.	Dimensions	do mm	s mm	p mm	bar	Pallet/ Pack	Box/M QTY	UOM	Price per m/each
1062883	14x2,0 120m	14	2	6		1320	120	m	1,88
1062884	14x2,0 240m	14	2	6		1680	240	m	1,84
1062885	14x2,0 960m	14	2	6		1920	960	m	1,66
1062044	16x2,0 120m	16	2	6		1080	120	m	1,93
1062045	16x2,0 240m	16	2	6		1440	240	m	1,93
1062046	16x2,0 640m	16	2	6		1280	640	m	1,93
1009229	20x2,0 60m	20	2	6		660	60	m	4,18
1009228	20x2,0 120m	20	2	6		840	120	m	4,18
1009230	20x2,0 240m	20	2	6		960	240	m	4,18
1009231	20x2,0 480m	20	2	6		960	480	m	4,18
1009232	20x2,0 1000m	20	2	6			1000	m	4,09

Comfort Pipe PLUS

Uponor Comfort Pipe PLUS

- 6 bar at 80°C
- Application class 4 and 5

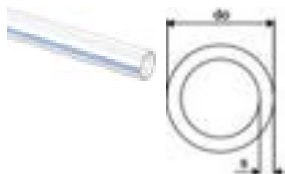

Item No.	Dimensions	do mm	s mm	p bar	Pallet/ Pack	Box/M QTY	UOM	Price per m/each
1062888	25x2,3 220m	25	2,3	6	440	220	m	4,58
1062889	25x2,3 300m	25	2,3	6	600	300	m	4,67
1063907	25x2,3 640m	25	2,3	6		640	m	4,67

Uponor Comfort Pipe PLUS insulated 13mm

- 6 bar at 80°C
- 13 mm insulation $\lambda=0,037$ W/mK



Item No.	Dimensions	do mm	s mm	di mm	Pallet/ Pack	Box/M QTY	UOM	Price per m/each
1020543	20x2,0 60m	20	2	13	480	60	m	7,72

Comfort Pipe



Benefits

- Proven PE-Xa quality for long service life
- Reliable oxygen diffusion resistance protecting system components
- Suitable for standard underfloor heating applications
- Flexible installation with a broad range of dimensions
- Compatible with Uponor radiant heating systems

Uponor Comfort Pipe is a PE-Xa radiant pipe designed for underfloor heating and low-temperature radiator applications. It provides reliable performance for standard water-based heating systems with proven oxygen diffusion protection.

Application

- Underfloor heating and low temperature radiators
- Max design temperature: 80°C
- Malfunction temperature 100°C
- Design pressure 6 Bar at 70°C

Specification

- Pipes manufactured from cross-linked polyethylene (PE-Xa) acc. BS EN ISO 15875
- EVOH (ethylene vinyl alcohol) layer for oxygen diffusion resistance as per DIN 4726
- Application class 4 - Underfloor heating and low temperature radiators
- Fire class E according to BS EN 13501-1.

Uponor Comfort Pipe Minitec

- Material: PE-Xa

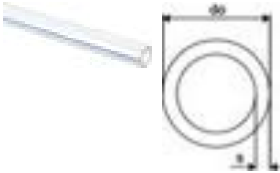

Item No.	Dimensions	do mm	do1 mm	s mm	p bar	Pallet/ Pack	Box/M QTY	UOM	Price per m/each
1063287	9,9x1,1 60m	9,9		1,1	6	840	60	m	2,03
1063288	9,9x1,1 120m	9,9		1,1	6	1680	120	m	2,03
1063289	9,9x1,1 240m	9,9		1,1	6	2640	240	m	2,03
1063381	9,9x1,1 480m	9,9		1,1	6	2880	480	m	2,03

Smart



Benefits

- Cost efficient pipe
- Flexible choice to fix the Smart UFH pipes with clamp track / cable ties on all relevant insulations.
- Suitable for all types of screeds.
- Fast and easy to install.

High quality, cost efficient PE-RT pipe solution for use in general under-floor heating and cooling systems.

Choose between tacker panels, clamp track or cable ties for steel mesh to efficiently fix the Smart UFH pipe. All components are designed to ensure highest safety and reliable operation.

Specification

- Smart underfloor heating system portfolio
- with Tacker panels and pipe fixations

Uponor Smart UFH-pipe

- UFH pipe made of PE-RT
- Complying with ISO 22391 and fulfils the requirement for oxygen diffusion resistance as per DIN 4726
- Compatible to Uponor Smart compression fittings
- Application class 4
- Design pressure 6 Bar at 70°C

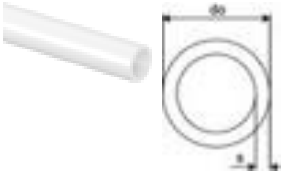

Item No.	Dimensions	do mm	s mm	p bar	Pallet/ Pack	Box/M QTY	UOM	Price per m/each
1086575	16x2,0 240m	16	2	6	1440	240	m	1,72
1086576	16x2,0 640m	16	2	6	1280	640	m	1,78
1086577	20x2,0 240m	20	2	6	960	240	m	2,60
1086578	20x2,0 480m	20	2	6	960	480	m	2,60

Application

- Underfloor heating systems
- Residential and light commercial heating installations
- Screeded floor constructions with thermal and impact sound insulation

Multi



Benefits

- Complete accessory range for radiant heating and cooling installations
- Supports multiple UFH system types (wet, dry, screed-based solutions)
- Durable materials (plastic, galvanized steel, aluminium) for long service life
- Helps ensure correct installation, pipe protection, and system performance

Uponor Multi is a comprehensive range of installation accessories and components designed for radiant heating and cooling systems.

The Multi range supports multiple underfloor heating solutions by providing everything from pipe fixation, bend supports, insulation and foils to expansion joints, screed additives, and heat emission plates.

Multi helps installers achieve reliable, compliant, and efficient installations across different construction methods and system types.

Specification

- UFH installation accessories and components for multiple systems

Uponor Multi bend support plastic

- Impact resistant plastic
- Bend support 90°

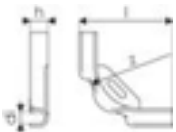

Item No.	Dimensions	d1 mm	l mm	z mm	h mm	Pallet/ Pack	Box/M QTY	UOM	Price per m/each
1135490	10-12	13	100	55	19	360	60	pce	2,08

Application

- Radiant heating and cooling systems

Multi

Uponor Multi bend support plastic

- Impact resistant plastic
- Bend support 90°

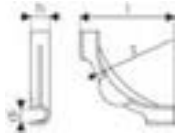

Item No.	Dimensions	d1 mm	l mm	z mm	h mm	Pallet/ Pack	Box/M QTY	UOM	Price per m/each
1135491	14-18	17	115	84	24	240	30	pce	3,00
1135492	20-22	20	144	100	28	140	35	pce	4,47

Uponor Multi bend support galv steel

- Galvanized steel
- Bend support 90°

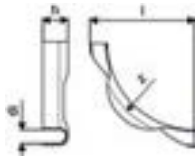

Item No.	Dimensions	d1 mm	l mm	z mm	h mm	Pallet/ Pack	Box/M QTY	UOM	Price per m/each
1033974	10	12	64	27	10	20000	10	pce	2,19
1009004	16	16,3	100	63	15	11000	10	pce	3,16
1009233	20	20	132	102	20	5000	20	pce	4,71
1009006	25	25,5	170	134	22	2340	10	pce	6,86
1001231	34	32	210	137	28	1400	2	pce	8,01

Uponor Multi foil PE

- PE-foil for installation on top of existing thermal insulation
- transparent



Item No.	Dimensions	s mm	b mm	Pallet/ Pack	Box/M QTY	UOM	Price per m/each
1005049	0,2mm 60x1,25m	0,2	1250	3375	75	m ²	1,53

Uponor Multi insulation panel XPS 400

- Thermal insulation made of XPS 400
- With tongue and groove at sides for easy mounting
- Thermal conductivity: $\lambda = 0.035$ W/mK
- Fire class E to BS EN 13501-1

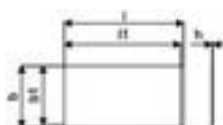

Item No.	Dimensions	L mm	W mm	H mm	W kg	Pallet/ Pack	Box/M QTY	UOM	Price per m/each
1084161	10X600X1250mm	600	1250	10	0,3	360	30	m ²	7,91
1084207	20X600X1250mm	600	1250	20	0,6		15,75	m ²	13,48

Multi

Uponor Multi PE edging strip with foil

- Edging strip, conforming to DIN 18560
- Made of polyethylene

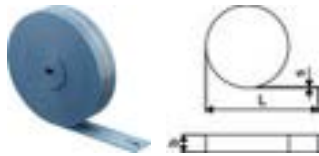

Item No.	Dimensions	s mm	b mm	Pallet/ Pack	Box/M QTY	UOM	Price per m/each
1000080	150x10mm	10	150		200	m	1,84

Uponor Multi PE edging strip with foil

- Edging strip, conforming to DIN 18560
- Made of polyethylene

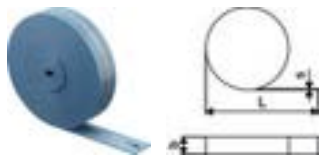

Item No.	Dimensions	s mm	b mm	Pallet/ Pack	Box/M QTY	UOM	Price per m/each
1000079	150x8mm	8	150		200	m	1,68

Uponor Multi PE edging strip with foil

- Edging strip with self-adhesive strip, conforming to DIN 18560
- Made of polyethylene



Item No.	Dimensions	b mm	s mm	Pallet/ Pack	Box/M QTY	UOM	Price per m/each
1135493	130x8mm	130	8		400	m	1,63

Uponor Multi PE edging strip with foil HB

- Edging strip with self-adhesive strip, conforming to DIN 18560
- Made of polyethylene



Item No.	Dimensions	b mm	s mm	Pallet/ Pack	Box/M QTY	UOM	Price per m/each
1135494	150x8mm	150	8		250	m	1,63

Uponor Multi expansion joint profile

- Self-adhesive PE/PET foam profile
- For separating screed sections and absorbing expansion



Item No.	Dimensions	s mm	Pallet/ Pack	Box/M QTY	UOM	Price per m/each
1090229	1800x100x10mm	10,0	720	18	m	7,36

Multi

Uponor Multi tape roll

- Self-adhesive tape for fixation of Tacker and Klett panels
- Results in screed-tightness acc DIN 18560



Item No.	Dimensions	L mm	W mm	H mm	W kg	Pallet/ Pack	Box/M QTY	UOM	Price per m/each
1000012	66m 50mm	108	108	50	0,24	36	1	pce	8,02

Uponor Multi joint protection tube

- Made of PE-LD, with slit opening
- For protection of UFH pipes up to 20mm in areas of expansion joints.



Item No.	Dimensions	s mm	Pallet/ Pack	Box/M QTY	UOM	Price per m/each
1000082	20mm 300x5mm	5,0	1800	30	pce	1,04

Uponor Multi heat emission plate AL

- Heat spreader made of Aluminium
- For use in Uponor systems with pipes dim 20mm and c-c 300mm

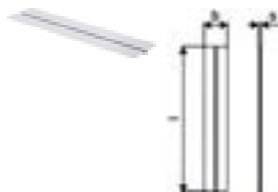

Item No.	Dimensions	l mm	s mm	b mm	Pallet/ Pack	Box/M QTY	UOM	Price per m/each
1009132	20mm 1150x280x0,55mm	1150	22	280	280	40	pce	15,01

Compatible with:

Item No.	Dimension	Pallet/ Pack	Box/M QTY	UOM	Price per m/each
1005290	Uponor Magna clamp track U-profile 25mm c/c50mm 3m	1320	30	m	7,22

Fix

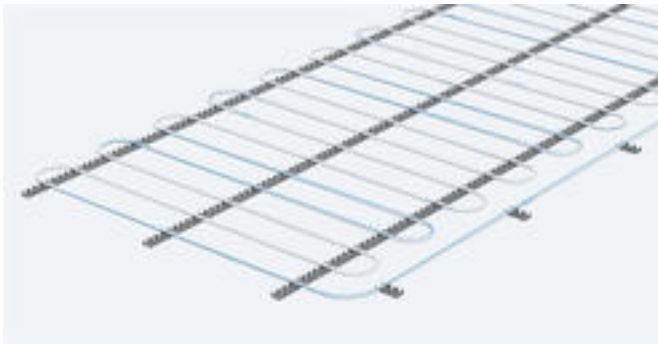

Benefits

- Universal: one system for ceiling, wall and underfloor heating
- Flexible: available for pipe dimensions 9.9, 12, 14, 16, 17, 20mm
- Comfort: short heat-up times, quickly adjustable
- Energy saving: low operating temperatures

Uponor radiant heating and cooling system for ceiling, wall and underfloor installation.

Installation is possible with additional thermal and impact noise insulation. Clamp tracks can be fixed by tape or integrated pins to enable easy installation of system pipes.

Specification

- Fix system for pipe fixation in walls, ceiling and underfloor installations
- Consists of clamp tracks for pipe fixings

Application

- Radiant underfloor heating and cooling
- Radiant wall and ceiling heating and cooling
- For use with plaster, cement- and anhydrite-based screeds

Certification

- DIN CERTCO: 7F277-W, 7F347-DW

Uponor Fix clamp track fixer

- Clamp track fixing clip
- For pipes 14-20mm

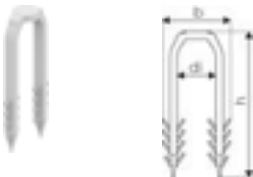

Item No.	Dimensions	di mm	b mm	h mm	Pallet/ Pack	Box/M QTY	UOM	Price per m/each
1135498	h=66mm	18	31	66	3600	200	pce	0,24

Uponor Fix clamp track

- clamp track for pipe 9.9mm
- c-c 20mm



Item No.	Dimensions	c/c1 mm	l mm	do mm	b mm	Pallet/ Pack	Box/M QTY	UOM	Price per m/each
1005274	9,9mm c/c20mm	2,5m	20	2500	10 24	25	2,50	m	2,22



Fix

Uponor Fix clamp track with pins

- For pipes 16-20mm
- c-c 50mm
- With fixing by pins



Item No.	Dimensions	c/c mm	di mm	l mm	Pallet/ Pack	Box/M QTY	UOM	Price per m/each
1135547	16-20mm	50mm	1m	50 20 1013	1000	100	pce	6,19

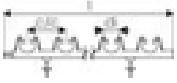

Uponor Fix clamp track with adhesive

- For pipes 16-20mm
- c-c 50mm
- With self-adhesive fixing



Item No.	Dimensions	c/c mm	di mm	l mm	Pallet/ Pack	Box/M QTY	UOM	Price per m/each
1135496	16-20mm	50mm	1m	50 20 1013	2000	100	pce	6,18

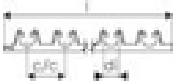

Mainfolds, cabinets and pump groups

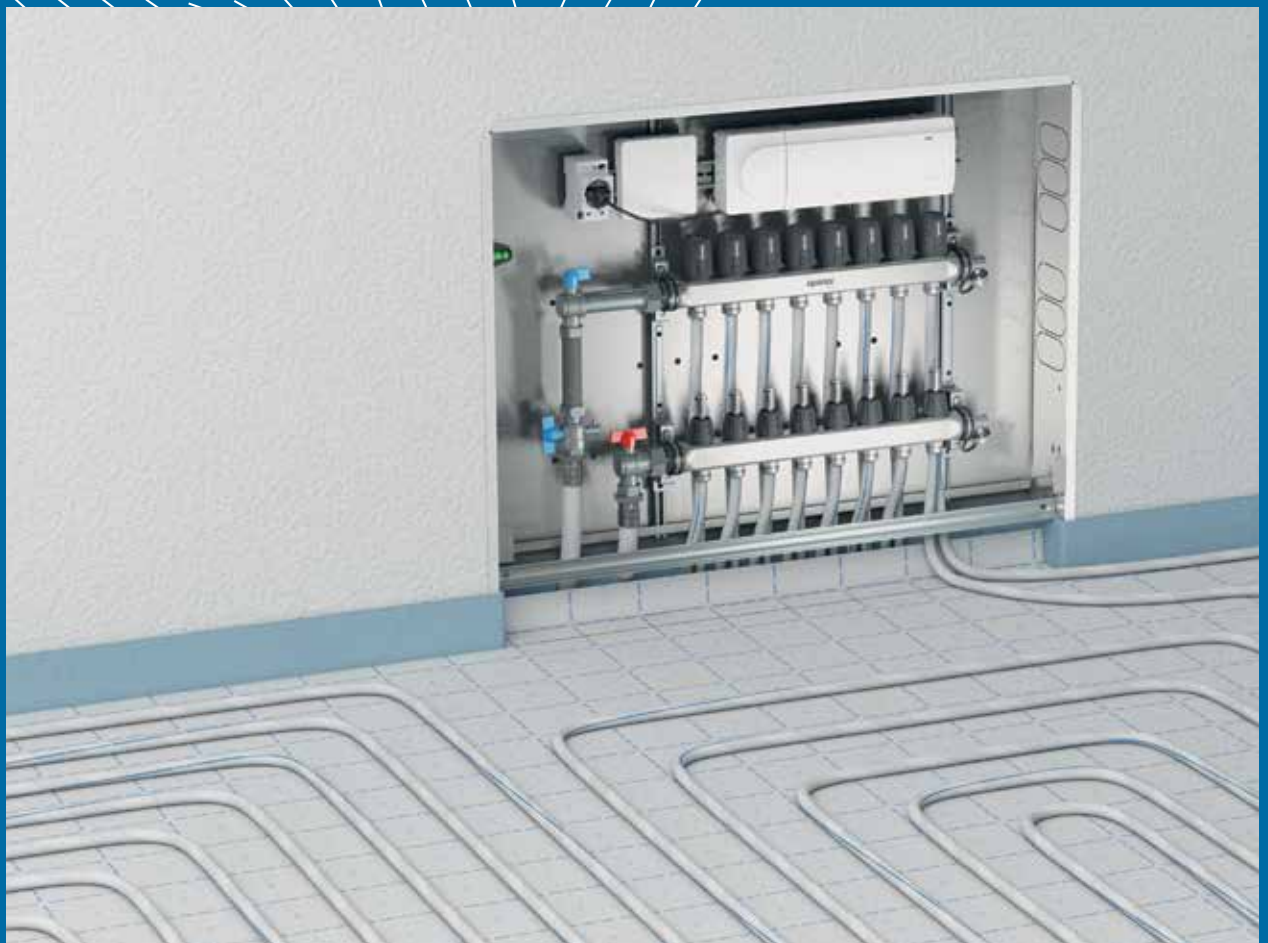

Vario S



Benefits

- For use in radiant heating and cooling systems
- Universal for underfloor heating and cooling systems
- Ensures a reliable, energy-efficient and comfortable operation
- Used in combination with Uponor actuators and zone controls, each room can be temperature optimised to provide the ultimate user comfort.

Uponor Vario S is a highly reliable stainless steel manifold for underfloor heating and cooling in residential and small commercial applications.

The 3/4" Eurocone outlets are compatible with a wide range of Uponor pipe dimensions from the PE-Xa, PE-RT and Multilayer ranges.

Specification

- Made of stainless steel, with integrated valves
- Connection right or left with flat sealing
- Integrated airvents and fill & drain points in supply/return
- Loop connection G3/4" Eurocone c-c 50 mm
- Header pitch 215 mm

Application

- For underfloor-heating and -cooling
- Applicable with actuators 1141676 (230V) and 1141677 (24V)
- Max. pressure: 6 bar at 60°C

Uponor Vario S manifold FM

- Supply beam with flowmeters for balancing and shutoff, with memory ring
- Return beam with valves for shutoff, with hand caps
- With primary connection G1

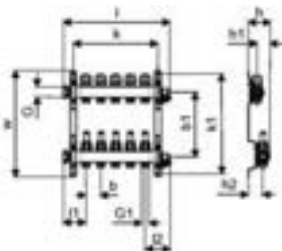

Item No.	Dimensions	l1 mm	l2 mm	l mm	b mm	b1 mm	h mm	h1 mm	h2 mm	k mm	k1 mm	w mm	Pallet/ Pack	Box/M QTY	UOM	Price per m/
1140833	2xG3/4 Euro - G1	77	87	214	50	217	73	30	50	135	336	357	108	1	pce	170,06
1140834	3xG3/4 Euro - G1	77	87	264	50	217	73	30	50	185	336	357	108	1	pce	219,51
1140835	4xG3/4 Euro - G1	77	87	314	50	217	73	30	50	235	336	357	90	1	pce	255,84
1140836	5xG3/4 Euro - G1	77	87	364	50	217	73	30	50	285	336	357	90	1	pce	302,01
1140837	6xG3/4 Euro - G1	77	87	414	50	217	73	30	50	335	336	357	90	1	pce	342,47
1140838	7xG3/4 Euro - G1	77	87	464	50	217	73	30	50	385	336	357	54	1	pce	392,07
1140839	8xG3/4 Euro - G1	77	87	514	50	217	73	30	50	435	336	357	54	1	pce	431,83
1140840	9xG3/4 Euro - G1	77	87	564	50	217	73	30	50	485	336	357	54	1	pce	495,44
1140841	10xG3/4 Euro - G1	77	87	614	50	217	73	30	50	535	336	357	54	1	pce	540,53
1140842	11xG3/4 Euro - G1	77	87	664	50	217	73	30	50	585	336	357	54	1	pce	594,35
1140843	12xG3/4 Euro - G1	77	87	714	50	217	73	30	50	635	336	357	54	1	pce	638,89
1140844	13xG3/4 Euro - G1	77	87	764	50	217	73	30	50	685	336	357	36	1	pce	696,66
1140845	14xG3/4 Euro - G1	77	87	814	50	217	73	30	50	735	336	357	36	1	pce	751,91
1140846	15xG3/4 Euro - G1	77	87	864	50	217	73	30	50	785	336	357	36	1	pce	782,05
1140847	16xG3/4 Euro - G1	77	87	914	50	217	73	30	50	835	336	357	36	1	pce	858,97

Vario S

Uponor Vario S manifold LS

- Supply beam with lock shield valves for balancing and shutoff
- Return beam with valves for shutoff, with hand caps
- With primary connection G1

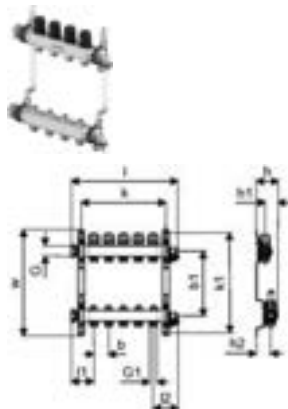

Item No.	Dimensions	l1 mm	l2 mm	b mm	b1 mm	h mm	h1 mm	h2 mm	k mm	k1 mm	w mm	Pallet/ Pack	Box/M QTY	UOM	Price per m/each
1140863	2xG3/4 Euro - G1	214	87	50	217	73	30	50	135	336	357	108	1	pce	169,00
1140864	3xG3/4 Euro - G1	264	87	50	217	73	30	50	185	336	357	108	1	pce	208,88
1140865	4xG3/4 Euro - G1	314	87	50	217	73	30	50	235	336	357	90	1	pce	240,89
1140866	5xG3/4 Euro - G1	364	87	50	217	73	30	50	285	336	357	90	1	pce	282,16
1140867	6xG3/4 Euro - G1	414	87	50	217	73	30	50	335	336	357	90	1	pce	319,15
1140868	7xG3/4 Euro - G1	464	87	50	217	73	30	50	385	336	357	54	1	pce	364,02
1140869	8xG3/4 Euro - G1	514	87	50	217	73	30	50	435	336	357	54	1	pce	399,28
1140870	9xG3/4 Euro - G1	564	87	50	217	73	30	50	485	336	357	54	1	pce	454,69
1140871	10xG3/4 Euro - G1	614	87	50	217	73	30	50	535	336	357	54	1	pce	498,96
1140872	11xG3/4 Euro - G1	664	87	50	217	73	30	50	585	336	357	54	1	pce	547,35
1140873	12xG3/4 Euro - G1	714	87	50	217	73	30	50	635	336	357	54	1	pce	587,17
1140874	13xG3/4 Euro - G1	764	87	50	217	73	30	50	685	336	357	36	1	pce	591,36
1140875	14xG3/4 Euro - G1	814	87	50	217	73	30	50	735	336	357	36	1	pce	636,11
1140876	15xG3/4 Euro - G1	864	87	50	217	73	30	50	785	336	357	36	1	pce	680,82
1140877	16xG3/4 Euro - G1	914	87	50	217	73	30	50	835	336	357	36	1	pce	727,56

Uponor Vario S thermometer

- For displaying flow or return temperature
- 1 piece



Item No.	di mm	do mm	h mm	Pallet/ Pack	Box/M QTY	UOM	Price per m/each
1086537	5	64	5	10	1	set	22,08

Uponor Vario S manifold return valve

- Return valve for Vario S UFH manifold



Item No.	In/Out	l1 mm	l mm	do mm	Pallet/ Pack	Box/M QTY	UOM	Price per m/each
1087609	12.34	33	54	30	280	10	pce	10,16

Uponor Vario S manifold flowmeter gen.2

- Flowmeter for stainless steel manifold Vario S
- Replacement for item 1087608
- 0-5 l/min.
- With mechanical stop during opening/closing position



Item No.	In/Out	Dimensions	G inch	l1 mm	l mm	do mm	Pallet/ Pack	Box/M QTY	UOM	Price per m/each
1184878	12.25	0-5 l/min.	1/2	51	97	31		10	pce	11,34

Vario S

Uponor Vario S manifold FM glass gen.2

- Flowmeter glass

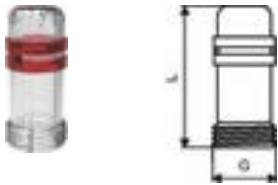

Item No.	In/Out	Dimensions	l mm	M mm	Pallet/ Pack	Box/M QTY	UOM	Price per m/each
1184879	12.25	0-5 l/min.	40,1	18		10	pce	4,49

Uponor Vario S valve LS

- Flow valve insert for Vario S manifold (spare part)



Item No.	G inch	l mm	Pallet/ Pack	Box/M QTY	UOM	Price per m/each
1088056	1/2	37,5		10	pce	6,83

Compatible with:

Item No.	Dimension	Pallet/ Pack	Box/M QTY	UOM	Price per m/each
1141676	Uponor Vario actuator NC FT 230V 1W IP54	100	1	pce	47,58
1141677	Uponor Vario actuator NC FT 24V 1W IP54	100	1	pce	46,10
1137413	Uponor Vario balancing valve G1-Rp1	10	1	set	131,73
1059132	Uponor Vario ball valve NP G1-G1	10	1	set	53,96
1086558	Uponor Vario ball valve 3/4-G1	10	1	set	39,14
1086559	Uponor Vario ball valve, elbow Rp 3/4" - G1"		1	set	51,72
1005107	Uponor Vario supply valve 1/2" - G3/4	50	1	pce	39,94
1005108	Uponor Vario return valve 1/2" - G3/4	50	1	pce	38,92
1001337	Uponor Aqua PLUS manif end cap flat seal 3/4"FT	250	10	pce	6,39

Vario B



Benefits

- Ready to install
- Pre-assembled bars with 2-12 heating circuits
- Can be installed in the Vario cabinets
- Compact installation combined with pump groups, Uponor control units and heat meter connections

Uponor Vario B is a brass manifold for underfloor heating in residential applications that provides easy installation with high reliability.

The secondary G 3/4" eurocone connectors allow the connection of all Uponor pipe dimensions which makes the manifold universal for Uponor underfloor heating and cooling systems.

Specification

- Made of brass
- With integrated valves
- Connection right or left with flat sealing supply
- With lockshield valve or flowmeter for balancing and shutoff
- no primary connection to combine it with the correct accessories
- Loop connection G3/4" eurocone
- Loop distance 50 mm
- Bracket distance 210 mm

Application

- For underfloor heating and cooling
- Combineable with actuators FT 30x1,5
- Max. pressure: 6 bar at 60°C

Uponor Vario B cap f. return, blue WGF

- End cap for Vario B (WGF) manifold



Item No.	In/Out	L mm	W mm	H mm	W kg	Pallet/ Pack	Box/M QTY	UOM	Price per m/each
1034558	12.28	18	18	7	0,01		1	pce	3,83

Uponor Vario B supply valve inset WGF

- Supply valve insert for Vario B (WGF) manifold



Item No.	In/Out	L mm	W mm	H mm	W kg	Pallet/ Pack	Box/M QTY	UOM	Price per m/each
1034556	12.32	27	37	50	0,066	200	1	pce	17,68

Uponor Vario B O-ring set CCP V4

- For Vario Manifolds



Item No.	In/Out	L mm	W mm	H mm	W kg	Pallet/ Pack	Box/M QTY	UOM	Price per m/each
1002369	12.28	20	20	2	0,05		1	pce	19,20

Vario B

Uponor Vario B handwheel WGF

- Plastic cap



Item No.	In/Out	Dimensions	L mm	W mm	H mm	W kg	Pallet/ Pack	Box/M QTY	UOM	Price per m/each
1009141	12.28	M28	40	35	40	0,057		1	pce	22,40

Uponor Vario B by-pass WGF

- Made of brass and plastic



Item No.	In/Out	Dimensions	G inch	G1 inch	L1 mm	L2 mm	L mm	z1 mm	Pallet/ Pack	Box/M QTY	UOM	Price per m/each
1009119	12.28	S,G1/2	1/2	1/2	28	8	185,9	149,9	20	1	pce	66,77

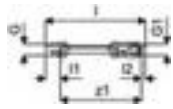

Uponor Vario B by-pass WGF

- Made of brass and plastic



Item No.	In/Out	Dimensions	L mm	W mm	H mm	W kg	Pallet/ Pack	Box/M QTY	UOM	Price per m/each
1009120	12.28	XL900 G1/2	200	110	50	0,496	5	1	pce	140,62

Uponor Vario B reducer HTG

- For Vario Manifolds



Item No.	In/Out	Dimensions	L mm	W mm	H mm	W kg	Pallet/ Pack	Box/M QTY	UOM	Price per m/each
1002377	12.28	1"-1/2"	40	20	40	0,1		1	pce	7,43

Uponor Vario B return valve inset WGF

- Return valve insert for Vario B (WGF) manifold



Item No.	In/Out	Dimensions	L mm	W mm	H mm	W kg	Pallet/ Pack	Box/M QTY	UOM	Price per m/each
1034557	12.33	18 18 40	18	18	40	0,04		1	pce	14,36

Vario B

Uponor Vario B flowmeter WGF

- Made of brass

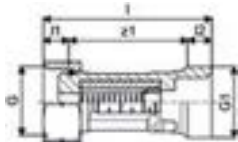

Item No.	In/Out	Dimensions	G inch	G1 inch	l1 mm	l2 mm	l mm	z1 mm	Pallet/ Pack	Box/M QTY	UOM	Price per m/each
1009142	12.28	G3/4 2-8 l/min	3/4	3/4	9,5	9	62,5	44		12	pce	58,85

Compatible with:

Item No.	Dimension	Pallet/ Pack	Box/M QTY	UOM	Price per m/each
1141676	Uponor Vario actuator NC FT 230V 1W IP54	100	1	pce	47,58
1141677	Uponor Vario actuator NC FT 24V 1W IP54	100	1	pce	46,10
1140963	Uponor Vario manifold flowmeter 0-5l/min	20	1	pce	6,17
1005108	Uponor Vario return valve 1/2" - G3/4	50	1	pce	38,92
1140964	Uponor Vario manifold return valve M30x1,5	20	1	pce	7,99
1009196	Uponor FPL-X compression adapter 20x2,0-G3/4"	50	1	pce	11,40
1137413	Uponor Vario balancing valve G1-Rp1	10	1	set	131,73
1059132	Uponor Vario ball valve NP G1-G1	10	1	set	53,96
1086558	Uponor Vario ball valve 3/4-G1	10	1	set	39,14
1086559	Uponor Vario ball valve, elbow Rp 3/4" - G1"		1	set	51,72
1005107	Uponor Vario supply valve 1/2" - G3/4	50	1	pce	39,94
1001337	Uponor Aqua PLUS manif end cap flat seal 3/4"FT	250	10	pce	6,39

Vario PLUS



Uponor Vario PLUS is a high quality manifold made of glass fiber reinforced polyamide. Intended for use with underfloor heating and cooling applications that demand easy installation and high reliability.

Deliverable in modular sections of 1, 3, 4 and 6 loops, and corresponding fill/drain/ventilation fittings or connection sets.

The secondary outlets allow the connection of all Uponor pipe dimensions making the manifold universal for Uponor underfloor heating and cooling systems.

Specification

- Modular fiberglass-reinforced polyamide manifold with 1,3,4,6 loops for connection with basic kit
- Connection right or left with flat sealing, or connection from below with optional elbow set
- Supplied with lockshield (LS) valve for balancing, or supplied with Flowmeter (FM) for balancing
- Shut-off and flow view
- Adjusting ring for balancing without tools
- Prepared are to apply room name labels
- Return with valves and caps, prepared for actuators
- Loop connection G3/4" Eurocone
- Loop pitch 50 mm
- Header pitch 225 mm

Actuator: NC (normally closed) closes without power

Uponor Vario PLUS thermometer

- Made of polycarbonate
- For mounting at the connection set
- Consists of two click thermometers



Item No.	Dimensions	L mm	W mm	H mm	W kg	Pallet/ Pack	Box/M QTY	UOM	Price per m/each
1034524	D=40mm	40	40	15	0,019	20	1	set	25,18

Benefits

- Modular manifold segments 1, 3, 4 and 6 loops
- Also suitable for large heating / cooling surfaces in residential and commercial areas
- Compact installation
- Combines with pump groups, Uponor control units and heat meter connection sets in Uponor cabinets
- Option available with or without flow indicator

Application

- For underfloor heating and cooling
- Compatible with actuators MT 30x1,5

Certification

- CE

Vario PLUS

Uponor Vario PLUS automatic air vent

- For Vario Manifolds



Item No.	Dimensions	L mm	W mm	H mm	W kg	Pallet/ Pack	Box/M QTY	UOM	Price per m/each
1038166	3/8"	75	40	40	0,04	10	1	pce	10,30

Uponor Vario PLUS flowmeter

- With shut-off function



Item No.	Dimensions	l1 mm	l mm	do mm	Pallet/ Pack	Box/M QTY	UOM	Price per m/each
1009217	4 l/min	74	146	38	20	1	pce	15,90

Uponor Vario PLUS hose connection

- Fits Vario PLUS manifold end connection for filling/pressure test
- R 3/4"



Item No.	Dimensions	G inch	l1 mm	l2 mm	l mm	z1 mm	Pallet/ Pack	Box/M QTY	UOM	Price per m/each
1009214	G3/4 x 1/2	0,75	8,8	22,8	35	3,4	10	1	pce	5,77

Uponor Vario PLUS connection set

- For Uponor Vario Plus manifolds with special-thread for tool-free connection from either left or right
- Consists of 2 segments
- One segment with 1/2" thread (plugged) prepared for heatmeter immersion sensor in combination with
- 1062462 Uponor HM Nipple for temperature sensor G1/2"xM10x1

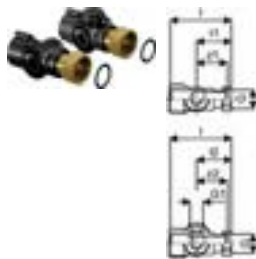

Item No.	G inch	G1 inch	l1 mm	l mm	z1 mm	Pallet/ Pack	Box/M QTY	UOM	Price per m/each
1005227	1	0,5	57	99	50	10	1	set	98,28

Uponor Vario PLUS supply valve inset scale 1-5

- For flow regulation in supply bar in Vario Plus manifold
- With shut-off function



Item No.	l1 mm	l mm	do mm	Pallet/ Pack	Box/M QTY	UOM	Price per m/each
1034523	28,5	92	38		20	pce	20,11

Vario PLUS

Uponor Vario PLUS return valve inset

- For flow regulation in return, shut-off function



Item No.	L mm	W mm	H mm	W kg	Pallet/ Pack	Box/M QTY	UOM	Price per m/each
1005250	45	20	20	0,014	10	1	pce	14,77

Uponor Vario PLUS manifold w. valve

- With valve and Eurocone thread

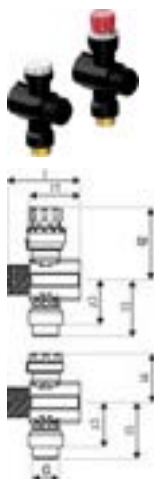

Item No.	Dimensions	G inch	p bar	Pallet/ Pack	Box/M QTY	UOM	Price per m/each
1042420	LS 1x3/4 Euro	0,75	6	10	1	set	51,66
1030580	LS 3x3/4 Euro	6		290	1	set	137,76
1030581	LS 4x3/4 Euro	6		225	1	set	179,12
1030582	LS 6x3/4 Euro	6		155	1	set	261,73

Uponor Vario PLUS manifold flowmeter

- Modules for Vario PLUS manifold

- With flowmeter



Item No.	Dimensions	G inch	l1 mm	l2 mm	l3 mm	l mm	b mm	z3 mm	p bar	Pallet/ Pack	Box/M QTY	UOM	Price per m/each
1042471	FM 1x3/4 Euro	0,75	50	119	63	74	50	50	6	10	1	set	61,61
1030583	FM 3x3/4 Euro	0,75	150	119	63	174	50	50	6	174	1	set	167,75
1030584	FM 4x3/4 Euro	0,75	200	119	63	224	50	50	6	135	1	set	219,10
1030585	FM 6x3/4 Euro	0,75	300	119	63	324	50	50	6	93	1	set	321,67

Uponor Vario PLUS manifold kit

- Including:
- Brackets
- Flat sealing screw connection pieces with swivel nut
- Thermometer and end pieces with air vent
- Filling and draining tap and a by-pass



Item No.	Dimensions	L mm	W mm	H mm	W kg	Pallet/ Pack	Box/M QTY	UOM	Price per m/each
1009209	K1	15	50	320	0,73	248	1	pce	136,04

Vario PLUS

Uponor Vario PLUS actuator NC

- Vario PLUS, MAGNA manifold actuator
- Height: 61 mm + adaptor ring
- Stroke length: 5mm
- Connection cable: 2x 0.75mm²x1m



Item No.	Dimensions	do mm	h mm	Pallet/ Pack	Box/M QTY	UOM	Price per m/each
1141678	MT 230V 1W IP54	50	83	100	1	pce	50,65
1141679	MT 24V 1W IP54	50	83	100	1	pce	60,32

Uponor Vario PLUS overflow valve

- Adjustable differential pressure regulation



Item No.	Dimensions	L mm	W mm	H mm	W kg	Pallet/ Pack	Box/M QTY	UOM	Price per m/each
1046884	225mm	120	70	30	0,177	640	1	pce	85,40

Compatible with:

Item No.	Dimension	Pallet/ Pack	Box/M QTY	UOM	Price per m/each
1065282	Uponor Vario compression adapter PEX 12x1,7-G3/4"FT Euro	25	1	pce	9,16
1065284	Uponor Vario compression adapter PEX 16x1,8/2,0-G3/4"FT Euro	25	1	pce	11,10
1065290	Uponor Vario compression adapter PEX 20x1,9/2,0-G3/4"FT Euro	25	1	pce	7,80
1137413	Uponor Vario balancing valve G1-Rp1	10	1	set	131,73
1059132	Uponor Vario ball valve NP G1-G1	10	1	set	53,96
1086558	Uponor Vario ball valve 3/4-G1	10	1	set	39,14
1086559	Uponor Vario ball valve, elbow Rp 3/4" - G1"		1	set	51,72
1005107	Uponor Vario supply valve 1/2" - G3/4	50	1	pce	39,94
1005108	Uponor Vario return valve 1/2" - G3/4	50	1	pce	38,92
1001337	Uponor Aqua PLUS manif end cap flat seal 3/4"FT	250	10	pce	6,39

Vario



Benefits

- Complete accessory portfolio for Vario manifolds
- Precise hydraulic control and balancing
- High compatibility across Vario generations
- Durable materials for reliable long-term operation
- Simplifies installation, commissioning, and upgrades

Vario Accessories comprise a comprehensive range of valves, fittings, adapters, actuators, and control components designed to complete, extend, and optimize Uponor Vario manifold installations.

The range ensures precise hydraulic balancing, safe operation, and seamless system integration.

Specification

- Components made of brass, nickel-plated brass, steel, and engineered plastics
- Eurocone, threaded, and flat-sealing connections
- Compatible with Vario B, C, S, M, PLUS, and MAGNA manifolds
- Includes valves, flowmeters, air vents, actuators, and adapters
- Designed for heating and cooling applications

Application

- To compliment/extend Vario manifold installations
- Flow regulation, balancing, and shut-off
- Connection of PEX, MLCP, and composite pipes
- Integration of actuators, sensors, and control units
- Commissioning, maintenance, and system optimization

Uponor Vario compression adapter PEX

- Eurocone
- Brass

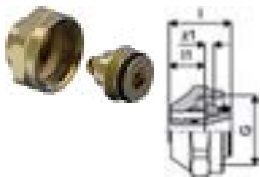

Item No.	Dimensions	G inch	l1 mm	l mm	s mm	z1 mm	Pallet/ Pack	Box/M QTY	UOM	Price per m/each
1065282	12x1,7-G3/4"FT Euro	0,75	12,9	22,5	1,7	3,2	25	1	pce	9,16
1065284	16x1,8/2,0-G3/4"FT Euro	0,75	12,9	22,5	1,8/2,0	3	25	1	pce	11,10
1065290	20x1,9/2,0-G3/4"FT Euro	0,75	14,1	23,7	1,9/2,0	2,9	25	1	pce	7,80
1065291	25x2,3-G3/4"FT Euro	0,75	14,1	27	2,3	6,9	25	1	pce	23,98

Uponor Vario fill and drain valve

- For Pumpgroup Push 12
- With rotatable hose connection



Item No.	Dimensions	G inch	G1 inch	Pallet/ Pack	Box/M QTY	UOM	Price per m/each
1061802	3/4" - 3/4"	0,75	0,75	10	1	set	46,36

Vario

Uponor Vario balancing valve

- Balancing and shut-off of manifolds
- For zone control with Uponor actuator M30x1.5mm MT
- Housing - brass
- Hand wheels - polyamide
- Max. test pressure 10 bar

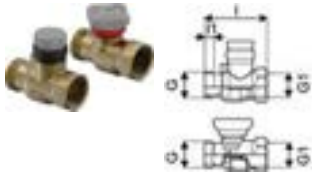

Item No.	Dimensions	l1	l2	l	h	h1	z1	Pallet/ Pack	Box/M QTY	UOM	Price per m/each
1137413	G1-Rp1	12	15	80	56	46	53	10	1	set	131,73

Uponor Vario ball valve

- Made of brass nickel-plated
- Flat sealing connection G1
- 60 mm + length of the manifold



Item No.	Dimensions	G	G1	l1	l2	l	h	z1	Pallet/ Pack	Box/M QTY	UOM	Price per m/each
1059132	NP G1-G1	1	1	12	12	70	51	46	10	1	set	53,96

Uponor Vario ball valve

- Made of brass, nickel-plated



Item No.	Dimensions	G	G1	l1	l2	l3	l	z1	Pallet/ Pack	Box/M QTY	UOM	Price per m/each
1086558	3/4-G1	1	0,75	12	8	43	51	31	10	1	set	39,14

Uponor Vario ball valve, elbow

- Made of brass, nickel-plated

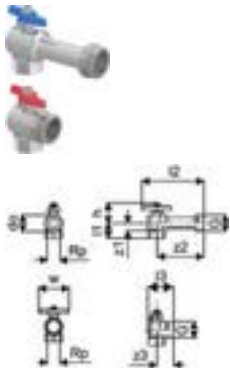

Item No.	Dimensions	G	Rp	l1	l2	l3	do	h	w	z1	z2	z3	Pallet/ Pack	Box/M QTY	UOM	Price per m/each
1086559	Rp 3/4" - G1"	1	3/4	31	123	51,5	33	42,5	60	22	93	32,5	1	1	set	51,72

Vario

Uponor Vario supply valve

- Made of brass
- Balancing valve with Eurocone
- White hand wheel

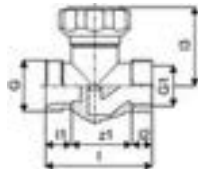

Item No.	Dimensions	G inch	G1 inch	l1 mm	l2 mm	l3 mm	l mm	z1 mm	Pallet/ Pack	Box/M QTY	UOM	Price per m/each
1005107	1/2" - G3/4	3/4	1/2	13,5	10,5	46	55	31,1	50	1	pce	39,94

Uponor Vario return valve

- For Vario C and Vario B manifolds



Item No.	Dimensions	L mm	W mm	H mm	W kg	Pallet/ Pack	Box/M QTY	UOM	Price per m/each
1005108	1/2" - G3/4	30	50	75	0,176	50	1	pce	38,92

Uponor Vario manifold return valve

- For Vario S manifolds
- Connection to actuator: M30x1,5

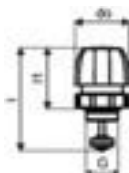

Item No.	Dimensions	G inch	l1 mm	l mm	do mm	Pallet/ Pack	Box/M QTY	UOM	Price per m/each
1140964	M30x1,5	1/2	40,8	68,6	35,8	20	1	pce	7,99

Uponor Vario manifold flowmeter

- For Vario S
- Flow range 0-5 l/min

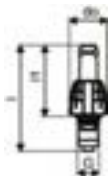

Item No.	Dimensions	G inch	l1 mm	l mm	do mm	Pallet/ Pack	Box/M QTY	UOM	Price per m/each
1140963	0-5l/min	1/2	67,8	101	36	20	1	pce	6,17

Vario

Uponor Vario actuator NC

- Vario M or S manifold actuator
- First open function,
- Height: 61 mm + adaptor ring
- Stroke length: 5mm
- Connection cable: 2x 0.75mm²x1m



Item No.	Dimensions	do mm	h mm	Pallet/ Pack	Box/M QTY	UOM	Price per m/each
1141676	FT 230V 1W IP54	50	83	100	1	pce	47,58
1141677	FT 24V 1W IP54	50	83	100	1	pce	46,10

Uponor Vario retrofit actuator NC

- Spare item for compact control packs V3, V4 and V5 including Varion B and WGF manifolds
- Incl. 4 bayonet manifold valve adaptor rings, mounting instructions
- Compatible to Vario B WGF and 80% of existing third-party manifolds
- First open function,
- Height: 61 mm + adaptor ring
- Stroke length: 5mm
- Connection cable: 2x 0.75mm²x1m



Item No.	Dimensions	do mm	h mm	Pallet/ Pack	Box/M QTY	UOM	Price per m/each
1141680	FT 230V 1W IP54	50	83	100	1	pce	44,63
1141681	FT 24V 1W IP54	50	83	100	1	pce	43,36

Vario



Benefits

- Integration of all Uponor manifolds and components such as pump groups, control units, connecting sets
- Easy to mount – Fully adjustable cabinets
- Easy mounting of manifolds on fully adjustable rails
- Manifold connections in vertical or horizontal direction
- Mounting point for Uponor control units
- Adjustable feet for adapting to floor construction

Uponor Vario Cabinets are designed for use as part of UFH installations in residential and commercial buildings.

Due to their flexibility it is possible to integrate all necessary system components such as:

- manifolds
- pump groups
- control units
- heat metering sets
- valves and connecting sets

Depending on the on-site conditions, the cabinets can be adjusted in depth and height.

Specification

- Cabinets made of galvanized steel with white powder coating
- Available for in-wall (IW) and on-wall (OW) installation
- Adjustable height, depth, and width for on-site flexibility
- Lockable doors; doors and frames available separately
- Designed for integration of manifolds, controls, and accessories

Uponor Vario cabinet OW

- Cabinet with door for on-wall installation
- Galvanized steel, white powder coated (RAL 9016)
- Without back panel
- Lockable door with coin lock

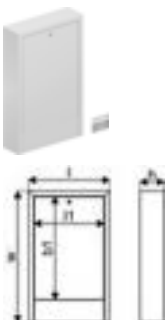

Item No.	Dimensions	l1 mm	l mm	b1 mm	h mm	w mm	Pallet/ Pack	Box/M QTY	UOM	Price per m/each
1136215	450x730x135	389	450	572	135	730	25	1	pce	106,03
1136216	600x730x135	539	600	572	135	730	17	1	pce	117,57
1136217	750x730x135	689	750	572	135	730	15	1	pce	93,60
1136218	900x730x135	839	900	572	135	730	12	1	pce	108,16
1136219	1050x730x135	989	1050	572	135	730	11	1	pce	113,12
1136220	1200x730x135	1139	1200	572	135	730	7	1	pce	167,46
1136221	1350x730x135	1289	1350	572	135	730	7	1	pce	177,68
1136222	1550x730x135	1489	1550	572	135	730	7	1	pce	193,98

Vario

Uponor Vario cabinet IW

- Complete cabinet with frame and door for in-wall installation
- Depth: 110mm, extendable to 150mm
- Height adjustable: 730 - 930mm
- Floor construction height: max. 200mm
- Material: galvanized steel
- White powder coated frame and door (RAL 9016)
- Lockable door

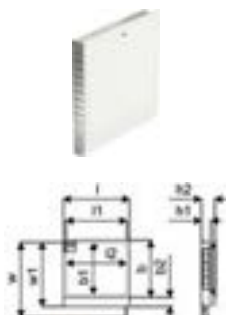

Item No.	Dimensions	l1 mm	l2 mm	l mm	b mm	b1 mm	b2 mm	h1 mm	h2 mm	w mm	w1 mm	Pallet/ Pack	Box/M QTY	UOM	Price per m/
1093473	550x730x110mm	550	538,6	605	650	572,2	107,5	110	150	930	730	18	1	pce	132,45
1093474	700x730x110mm	700	688,6	755	650	572,2	107,5	110	150	930	730	16	1	pce	166,34
1093475	850x730x110mm	850	838,6	905	650	572,2	107,5	110	150	930	730	13	1	pce	191,65
1093476	1000x730x110mm	1000	988,6	1055	650	572,2	107,5	110	150	930	730	12	1	pce	209,22
1093477	1150x730x110mm	1150	1138,6	1205	650	572,2	107,5	110	150	930	730	8	1	pce	227,34
1093478	1300x730x110mm	1300	1288,6	1355	650	572,2	107,5	110	150	930	730	8	1	pce	253,49

Uponor Vario cabinet rear board OW

- Back panel for on-wall cabinets
- Galvanized steel, white powder coated (RAL 9016)



Item No.	Dimensions	l mm	w mm	Pallet/ Pack	Box/M QTY	UOM	Price per m/each
1136223	450x730	430	560	5	1	pce	74,78
1136224	600x730	580	560	5	1	pce	79,63
1136225	750x730	730	560	5	1	pce	95,87
1136226	900x730	880	560	5	1	pce	97,21
1136227	1050x730	1030	560	5	1	pce	113,49
1136228	1200x730	1180	560	5	1	pce	116,06
1136229	1350x730	1330	560	5	1	pce	116,57
1136230	1550x730	1530	560	5	1	pce	118,88

Compatible with:

Item No.	Dimension	Pallet/ Pack	Box/M QTY	UOM	Price per m/each
1060553	Uponor Magna cabinet on-wall 1010x835x200mm		1	pce	400,51
1060554	Uponor Magna cabinet on-wall 1910x835x200mm		1	pce	581,71
1060555	Uponor Magna cabinet on-wall 2310x835x200mm		1	pce	702,97
1005266	Uponor Minitec adapter 9,9x1,1-G3/4" Euro	100	10	pce	11,76
1141678	Uponor Vario PLUS actuator NC MT 230V 1W IP54	100	1	pce	50,65
1141679	Uponor Vario PLUS actuator NC MT 24V 1W IP54	100	1	pce	60,32

Fluvia T



Benefits

- Complete preassembled units: hydraulically tested pipe network
- Pump Groups include all necessary components
- Supply water control function by Thermostat head or by Actuator
- With fixing brackets for mounting
- On-wall, or in Uponor Cabinets
- Easy operation

Uponor Fluvia T pump groups are complete, preassembled and fully tested units to be used as part of the UFH supply system in residential and commercial buildings.

Fluvia T Pump Groups includes all components necessary for connection in to the pipe network.

The functional control setting: constant supply hot water temperature control.

Specification

- Integrated pump: Q: 0,1 - 0,4 m³/h, H: 0,2 - 1,1 m, Phyd\leq 1W
- Bracket for left or right installation
- Air bleed screw
- Secondary circuit temp. range 20-50°C
- Balancing valve
- Secondary loop 3/4" Eurocone
- Primary valves with clamp connection for CU-Pipe 15mm

Uponor Fluvia T pump Grundfos Push-12

- For Uponor Fluvia T Pumpgroup PUSH-12 AC-G / WL-G / TH-G / CH-G



Item No.	G inch	l1 mm	l2 mm	l mm	b1 mm	b2 mm	h mm	Pallet/ Pack	Box/M QTY	UOM	Price per m/each
1095132	1/2	25	120	146	42	42	101	20	1	pce	364,36

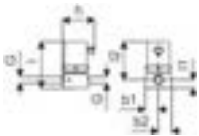

Fluvia T

Uponor Fluvia T pumpgroup Push-12 TH-G

- Integrated pump: Q: 0,1 - 0,4 m³/h, H: 0,2 - 1,1 m, Phyd< 1W
- Bracket for left or right installation
- Air bleed screw
- Secondary circuit temp. range 20-50°C
- Balancing valve
- Secondary loop 3/4" Eurocone
- Primary valves with clamp connection for CU-Pipe 15mm
- For control of UFH in small zones
- Max. primary temperature: 90°C
- Max. secondary temperature: 55°C
- Pumpgroup with thermostat 12-28°C
- Secondary max. temperature limiter 50°C
- Room sensor head with capillary sensor

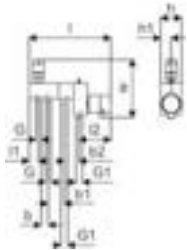

Item No.	G inch	G1 inch	I1 mm	I2 mm	L mm	b mm	b1 mm	b2 mm	h mm	h1 mm	w mm	Pallet/ Pack	Box/M QTY	UOM	Price per m/each
1095127	CU15	3/4	38	129	332	40	65	65	84	42	240	60	1	pce	795,55

Uponor Fluvia T pumpgroup Push-12 CH-G

- Integrated pump: Q: 0,1 - 0,4 m³/h, H: 0,2 - 1,1 m, Phyd< 1W
- Bracket for left- or right installation
- Air bleed screw
- Secondary circuit temp. range 20-50°C
- Balancing valve
- Secondary loop 3/4" eurocone
- Primary valves with clampconnection for CU-Pipe 15mm
- For control of UFH in small zones
- Max. primary temperature: 90°C
- Max. secondary temperature: 55°C
- With cartridge heater for UFH in summer mode
- Room temperature control by controller X-161
- Compatible to Uponor Smatrix Wave thermostats T-166, T-168 , T-169
- With safety sensor against overheating
- Secondary max. temperature limiter by 50°C

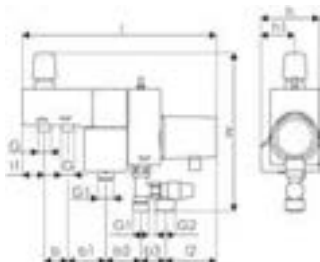

Item No.	G inch	G1 inch	G2 inch	I1 mm	I2 mm	L mm	M mm	M1 mm	b mm	b1 mm	b2 mm	h mm	h1 mm	w mm	Pallet/ Pack	Box/M QTY	UOM	Price per m/each	
1095131	3/4	3/4	3/4	32	38	87	331	22	32	40	65	60	100	58	271	30	1	pce	1 335,27

Fluvia T

Uponor Fluvia T pumpgroup Push-12 AC-G

- Integrated pump: Q: 0,1 - 0,4 m³/h, H: 0,2 - 1,1 m, Phyd< 1W
- Bracket for left or right installation
- Air bleed screw
- Secondary circuit temp. range 20-50°C
- Balancing valve
- Secondary loop 3/4" Eurocone
- Primary valves with clampconnection for CU-Pipe 15mm
- For control of UFH in small zones
- Max. primary temperature: 90°C
- Max. secondary temperature: 55°C
- Pumpgroup with actuator 230 V and cable room sensor
- Secondary max. temperature limiter 50°C

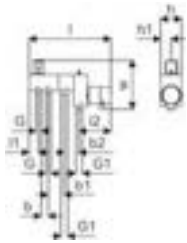

Item No.	G	G1	l1	l2	l	b	b1	b2	h	h1	w	Pallet/ Pack	Box/M QTY	UOM	Price per m/each
	inch	inch	mm	mm	mm	mm	mm	mm	mm	mm	mm				
1095128	5/8	3/4	38	129	332	40	65	60	84	42	202	60	1	pce	636,92

Uponor Fluvia T pumpgroup MPG-UK

- Integrated pump: Q: 0,1 - 0,4 m³/h, H: 0,2 - 1,1 m, Phyd< 1W
- Bracket for left or right installation
- Air bleed screw
- Secondary circuit temp. range 20-50°C
- Balancing valve
- Secondary loop 3/4" Eurocone
- Primary valves with clamp connection for CU-Pipe 15mm
- For control of UFH in small zones
- Max. primary temperature: 90°C
- Max. secondary temperature: 55°C
- Maximal heat load: 15 kW
- kvs flow valve: 3,2 m3/h
- Water temperature and flow rates controlled by thermostatic 4 way valve

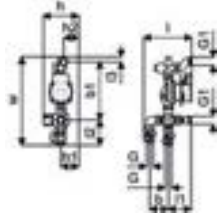

Item No.	Dimensions	G	G1	l1	l2	l3	l	b1	b2	h	h1	h2	Pallet/ Pack	Box/M QTY	UOM	Price per m/each
		inch	inch	mm	mm	mm	mm	mm	mm	mm	mm	mm				
1094185	15kW	3/4	1	93	103	45	197	76	215	129	50	30	70	1	pce	727,42

Fluvia



Benefits

- Preassembled units: hydraulically tested pipe
- Pre-wired
- Well designed pump group including all necessary components
- Supply water control function by Uponor Smatrix Move control units
- With fixing brackets for mounting on the wall or in Uponor cabinets
- Fluvia Move pump groups can be easily operated via the Smatrix menu

Uponor Fluvia pump groups are complete, preassembled and fully tested units to be used as part of the UFH supply systems in residential and commercial buildings.

Fluvia pump groups include all components necessary for connection in to the pipe network.

Functional control setting: weather compensated control of supply hot water temperature and optional control of supply cooling water temperature.

Specification

- Pre-mounted
- Fluvia Move pump groups with supply temperature controller Uponor Smatrix Move
- Fluvia T can be installed with brackets left or right on the installation

Application

- Max. primary temperature: 90°C
- Max. secondary temperature: 55 - 60°C

Uponor Fluvia thermostat Push-12 TH

- For Push 12



Item No.	L mm	W mm	H mm	W kg	Pallet/ Pack	Box/M QTY	UOM	Price per m/each
1059852	106	94	59	0,18		1	pce	130,60

Uponor Fluvia 4-way valve

- For pump group MPG-UK

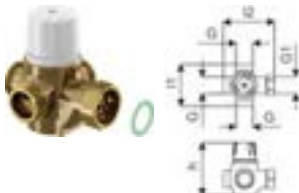

Item No.	Dimensions	G inch	G1 inch	h mm	Pallet/ Pack	Box/M QTY	UOM	Price per m/each
1095113	kvs=3,2 m3/h	1	1	104	10	1	pce	374,61

Fluvia

Uponor Fluvia pump Wilo Para SC

- Wilo pump 130mm for pump group MPG UK
- Wilo pump 180mm for pump groups CPG

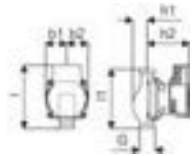

Item No.	Dimensions	G inch	l1 mm	l mm	b1 mm	b2 mm	h1 mm	h2 mm	Pallet/ Pack	Box/M QTY	UOM	Price per m/each
1095112	6m, 130mm	1	130	139	47	47	34	93	21	1	pce	547,94

Uponor Fluvia valve for Push-12

- For use with Push 12



Item No.	L mm	W mm	H mm	W kg	Pallet/ Pack	Box/M QTY	UOM	Price per m/each
1059851	100	92	29	0,489		1	pce	139,72

Uponor Fluvia Y compression adapter

- Made of brass
- For extension of PUSH-12 pump groups with 2 loops



Item No.	Dimensions	L mm	W mm	H mm	W kg	Pallet/ Pack	Box/M QTY	UOM	Price per m/each
1005675	2xG3/4-3/4" Euro	97	64	27	0,31	50	1	set	48,25

Uponor Fluvia end cap w. bleeder

- Made of brass

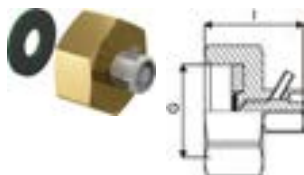

Item No.	Dimensions	G inch	l mm	p bar	Pallet/ Pack	Box/M QTY	UOM	Price per m/each
1008497	G3/4	3/4	26	6+10		200	pce	10,69

Uponor Fluvia max.temp.limiter

- Max.temp.limiter 5-60°C for pump stop



Item No.	Dimensions	L mm	W mm	H mm	W kg	Pallet/ Pack	Box/M QTY	UOM	Price per m/each
1005504	5-60deg	46	55	115	0,14	10	1	pce	64,53









Uponor Fluvia Pump IMP NMT mini

- For pump groups: Push 23, MPG and KRS 6



Item No.	Dimensions	L mm	W mm	H mm	W kg	Pallet/ Pack	Box/M QTY	UOM	Price per m/each
1134170	15/70-130	130	90	128	1,8		1	pce	430,62

Compatible with:

Item No.	Dimension	Pallet/ Pack	Box/M QTY	UOM	Price per m/each
 1095127	Uponor Fluvia T pumpgroup Push-12 TH-G	60	1	pce	795,55
 1095131	Uponor Fluvia T pumpgroup Push-12 CH-G	30	1	pce	1 335,27
 1095128	Uponor Fluvia T pumpgroup Push-12 AC-G	60	1	pce	636,92
 1061802	Uponor Vario fill and drain valve 3/4" - 3/4"	10	1	set	46,36
 1001337	Uponor Aqua PLUS manif end cap flat seal 3/4"FT	250	10	pce	6,39
 1095132	Uponor Fluvia T pump Grundfos Push-12	20	1	pce	364,36
 1094185	Uponor Fluvia T pumpgroup MPG-UK 15kW	70	1	pce	727,42
 1002357	Uponor Smatrix Move mixer motor 3 point 230V		1	pce	369,52

Base



Benefits

- Standard 230V wiring
- Wide selection of thermostats
- Easy to install and simple set-up
- Common wiring method and controls logic
- Easy integration to standard on/off time controls

An economical 230V room control system for radiant heating.

Simple to install and use, the system utilises a common wiring method for all controls making the installation fast and reliable.

Specification

- 230V standard wiring
- Common wiring method and controls logic
- Easy integration to standard on/off time control
- Optional: pump logic

Application

- Wired room temperature control for radiant heating

Certification

- CE, UKCA

Uponor Base controller H pump X-60

- Controller with autobalance function for 230V standard wiring
- Supports up to 6 thermostats (230V)
- Supports up to 12 actuators (230V), with 2 actuators at a time that follow a common thermostat (6x 2 actuators)
- Noiseless actuator switching
- Autobalancing in heating optimises energy use and comfort
- Switch to enable/disable the autobalance function
- Pump relay
- Time limit by-pass with autobalance
- Input: day/night switch
- 4 wires for thermostat connection
- Works with 3 wires thermostat (2 wires for power supply 230 V, 1 output 230 V demand) and 4 wires thermostat for full functionality (day/night signal)
- Connection terminals for thermostat/actuator 0,13 ... 1,5 mm²
- Overload protection
- Protection class: IP20

- Consisting of:

- Uponor Base controller X-60
- Without power cable
- Mounting material, DIN rail included

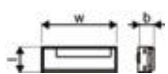

Item No.	Dimensions	l mm	b mm	h mm	w mm	Pallet/ Pack	Box/M QTY	UOM	Price per m/each
1138349	6x 230V	265	56	90		6	1	pce	264,97

Base

Uponor Base controller box 8X UK

- Supports up to 8 thermostats
- Supports up to 16 actuators
- Pump control
- Boiler control
- Night set back, 2 time zones
- Overload protection
- Optional: 2 time zone night setback if connected to timer (1002133 sold separately)
- Effective power per TA 230: 3W
- Protection class: IP20

- Consisting of:
 - Uponor Base controller box 8X
 - Connection port for time clock
 - Cable clamps
 - Mounting material

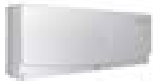

Item No.	In/Out	Dimensions	l mm	h mm	w mm	Pallet/ Pack	Box/M QTY	UOM	Price per m/each
1047456	12.33	230V	110	60	280		1	pce	264,97

Uponor Base thermostat T-23 standard

- Printed scale on dial thermostat
- Simple on/off control (bimetal)
- Setting range can be limited mechanically by moving pins under the dial
- Powered by base unit (Uponor Base controller X-23)
- Setpoint range: +5°C - +30°C
- Wire: 4x 1.5mm²
- max. cable length: 100m
- Protection class: IP30
- Colour: RAL 9010



Item No.	Dimensions	l mm	h mm	w mm	Pallet/ Pack	Box/M QTY	UOM	Price per m/each
1058422	230V RAL9010	75	15	80	160	1	pce	86,10

Uponor Base thermostat display T-27

- LCD display presents temperature in big sized digits
- Silent operation due to triac electronics
- Capacitive keys on the front and full display glass for easy cleaning
- Comfort / Eco mode
- Valve exercise
- Option to connect remote sensor 1071684 (ordered separately)
- Floor sensor modes: internal, external, internal + external
- Mounting: on wall and on standard European flush mounting box
- Easy wiring with Uponor Base X-23 and Uponor Base flexiboard X-24, X-25, X-26, X-27
- Protection class : IP30



Item No.	Dimensions	l mm	h mm	w mm	Pallet/ Pack	Box/M QTY	UOM	Price per m/each
1120075	230V RAL9016	85	85	22,5	75	1	pce	108,82

Base

Uponor Base thermostat T-26 dig. prog.

- In-side port for floor/remote sensor connection
- Fully programmable - 5/2 or 7 day with four heat levels per day
- Multiple control choice - air only, floor only, air and floor
- Holiday mode with override feature
- Optimised start
- Lock facility - tamper proof setting
- Status display on current thermostat mode
- Powered by base unit (Uponor Base controller X-23)
- Optional: remote sensor 1047459 (sold seperately)
- Setpoint range: +5°C - +35°C
- Protection class: IP20
- Colour: RAL9010



Item No.	Dimensions	l mm	h mm	w mm	Pallet/ Pack	Box/M QTY	UOM	Price per m/each
1058425	230V RAL9010	85	40	85		1	pce	133,70





Uponor Base sensor remote

- Remote sensor for T-26 or thermostat 1047457
- For min/max floor temperature
- Length: 3m



Item No.	Dimensions	l mm	h mm	w mm	Pallet/ Pack	Box/M QTY	UOM	Price per m/each
1047459	230V	72	20	72		1	pce	43,25

Compatible with:

Item No.	Dimension	Pallet/ Pack	Box/M QTY	UOM	Price per m/each
 1071684	Uponor Smatrix floor/remote sensor S-1XX	63	1	pce	13,16
 1141678	Uponor Vario PLUS actuator NC MT 230V 1W IP54	100	1	pce	50,65
 1141676	Uponor Vario actuator NC FT 230V 1W IP54	100	1	pce	47,58
 1141680	Uponor Vario retrofit actuator NC FT 230V 1W IP54	100	1	pce	44,63

Smatrix



Benefits

- Enables app for mobile devices, cloud connectivity, and additional applications for Smatrix Pulse systems
- Easy implementation of heating/cooling source changeover
- Modular add-ons to extend Base/Wave systems
- Fast and easy installation

Application

- Room temperature control for radiant heating and cooling
- App for mobile devices and cloud connectivity for Smatrix Pulse systems. Enables multi-controller installations, comfort settings, Smatrix AI, and many more
- Device interface to the heating/cooling source for changeover control

Uponor Smatrix is a product line of fully integrated control systems for radiant heating and cooling.

Developed to fully leverage the advantages of a radiant system, Smatrix increases energy-efficiency whilst ensuring optimal comfort.

The modular system includes controller, expansion module ,COM module with app for mobile devices, relay modules, thermostats and sensors

Additional modules expand functionality across many systems.

Uponor Smatrix Pulse com R-208

- Establishes connection between Uponor Smatrix Pulse system, Uponor Smatrix Pulse app and the Uponor cloud

- Compatible with:
 - Uponor Smatrix Base controller Pulse X-245 Bus 6X
 - Uponor Smatrix Wave controller Pulse X-265 6X
- Power supply: RJ45 cable to Uponor Wave or Base controller Pulse
- Ethernet interface: 10/100 Mbps (RJ45)
- Ethernet protocols: Ethernet II
- Protection class: Class II IP20
- Colour: white

- Consisting of:
 - Uponor Smatrix Pulse com R-208
 - Adaptor for DIN rail installations
 - RJ45 connection cable (2m)
 - First step instructions, safety instructions
 - Mounting material



Item No.	l mm	h mm	w mm	Pallet/ Pack	Box/M QTY	UOM	Price per m/each
1093030	110	20	110	16	1	pce	504,29

Uponor Smatrix relay module H/C M-1XX

- Interface to a heating/cooling source
- Switch over H/C between Uponor Smatrix and H/C source
- Incl. socket for DIN rail mounting, manual, mounting material, wall box
- Contact: 2 change-over (CO)
- Ucoil: 230VAC
- Test voltage: 5kV
- Protection class: IP40
- Switching voltage: 380VAC, 125VDC
- Switching current: 5A@250VAC, 5A@30VDC
- Contact material: Ag+Au plated
- Temperature range: -40°C - +70°C



Item No.	Dimensions	l mm	h mm	w mm	Pallet/ Pack	Box/M QTY	UOM	Price per m/each
1083577	230V	160	85	55	16	1	pce	121,78

Uponor Smatrix relay module H/C M-1XX

- Interface to a heating/cooling source
- Switch over H/C between Uponor Smatrix and H/C source
- Incl. socket for DIN rail mounting, manual, mounting material
- Contact: 2 change-over (CO)
- Ucoil: 24VDC
- Test voltage: 5kV
- Protection class: IP40
- Switching voltage: 380VAC, 125VDC
- Switching current: 5A@250VAC, 5A@30VDC
- Contact material: Ag+Au plated
- Temperature range: -40°C - +70°C



Item No.	Dimensions	l mm	h mm	w mm	Pallet/ Pack	Box/M QTY	UOM	Price per m/each
1083576	24V	80	60	15	84	1	pce	80,64

Uponor Smatrix floor/remote sensor S-1XX

- Can be combined with Uponor Smatrix Wave/Base (Pro) thermostats
- Can be combined with T-27 thermostat 1120075
- Can be used as floor or remote sensor
- Length: 3m
- Sensor type: NTC 10kOhm at 25



Item No.	l mm	h mm	w mm	Pallet/ Pack	Box/M QTY	UOM	Price per m/each
1071684	60	30	60	63	1	pce	13,16

Uponor Smatrix wallframe T-X A-1XX

- Wallframe for Uponor Smatrix thermostats (not compatible with T-247 and T-267)
- For thermostats T-247 and T-267 use 1144965 - Uponor Smatrix wallframe T-2XY A-2XX- Colour: white RAL9016



Item No.	Dimensions	l mm	h mm	w mm	Pallet/ Pack	Box/M QTY	UOM	Price per m/each
1086986	RAL9016	90	12	90	250	1	pce	4,71

Uponor Smatrix wallframe T-2XY A-2XX

- Wallframe for Uponor Smatrix thermostats T-247 and T-267
- Colour: white RAL9016



Item No.	In/Out	L mm	W mm	H mm	W kg	Pallet/ Pack	Box/M QTY	UOM	Price per m/each
1144965	04.25	90	90	12	0,028	250	1	pce	5,01

Smatrix Base



Uponor Smatrix Base, featuring autobalancing technology is an easy to use, intelligent room control system.

Autobalancing optimises energy use and comfort by constantly monitoring and adapting the system to changing demands. Smatrix Base offers a choice of wiring options adding flexibility and speed to an installation.

Specification

- Up to 4 controllers in one system
- Operating voltage: 230V
- Autobalancing optimises energy user and comfort
- Supports up to 6 room thermostats and 8 24V actuators per controller
- Pump and boiler relays
- Valve and pump exercise
- Relative humidity control
- Different wiring options (daisy-chain / star)
- 4-wire Bus installation
- Communication protocol: RS485 serial bus
- Max. power input per actuator: 24VAC / 0.2A (0.4A peak)

Smatrix Base Pulse:

- Local access (Wi-Fi) or remote access (internet connection required) via Uponor Smatrix Pulse App (with R-208)
- Temporary wi-fi access point for direct access (if local wi-fi is not available) - (with R-208)
- Smart home ecosystem integration (Amazon Alexa, Google Home) - (with R-208)
- Multi-home control - (with R-208)
- Third-party access for remote support (user allowance required) - (with R-208)
- History trend analysis via Uponor Smatrix Pulse app (with R-208)
- Timer programming (with R-208)
- Comfort settings (with R-208)
- Supply diagnostics (with R-208)

Uponor Smatrix Base wallframe T-141

- Wallframe for Sensor RH Style T-141 1087812
- Wallframe for Thermostat T-144 1086973
- Colour: white RAL9016



Item No.	Dimensions	l mm	h mm	w mm	Pallet/ Pack	Box/M QTY	UOM	Price per m/each
112237	RAL9016	81,5	10,6	81,5	20	1	pce	4,59

Benefits

- Can be used for both radiant heating and cooling
- No manual balancing required
- Fast installation
- Simple end user control
- Low maintenance

Application

- Wired room temperature control for radiant heating and cooling
- Set point range: +5°C - +35°C

Certification

- CE / EAC

Smatrix Base

Uponor Smatrix Base thermostat D+RH T-247 BUS

- Measures and displays the room temperature and relative humidity
- Compatible with controllers Smatrix Base Pulse (X-245), Smatrix Base Pro (X-147, X-148) and Smatrix Base (X-145)
- Colour: white RAL9016
- Functions:
 - Capacitive keys on the front
 - Heating or cooling demand indication
 - RH measured value
 - Comfort / ECO indication
 - ECO setback modification
 - Cooling allowed function (room by room)
 - Displays celsius or fahrenheit
 - Operating modes: room temperature (RT), internal with floor max/min (RFT), remote sensor (RS), remote outdoor (RO)
 - Room temperature calibration
 - Optional: floor, remote or outdoor sensor can be connected
- Consisting of:
 - Uponor Smatrix Base thermostat D+RH T-247 Bus
 - Mounting material



Item No.	In/Out	L mm	W mm	H mm	W kg	Pallet/Pack	Box/M QTY	UOM	Price per m/each
1144105	04.25	86	86	21	0,09	75	1	pce	89,93

Uponor Smatrix Base controller Pulse X-245 BUS 6X

- Compatible to Uponor Smatrix Base controller Pulse X-245 Bus 6X
- Protection class: Class II IP20
- Colour: white
- Consisting of:
 - Uponor Smatrix Base controller Pulse X-245 Bus 6X
 - First step instructions, safety instructions
 - Mounting set



Item No.	Dimensions	l mm	h mm	w mm	Pallet/Pack	Box/M QTY	UOM	Price per m/each
1093018	UK	340	50	110	4	1	pce	232,49

Uponor Smatrix Base slave module Pulse M-242 BUS 6X

- 6 channel slave module for Uponor Smatrix Base controller Pulse X-245 Bus 6X
- Supports up to 6 room thermostats and 6 actuators
- Click-in installation
- Protection class: IP20
- Colour: white



Item No.	l mm	h mm	w mm	Pallet/Pack	Box/M QTY	UOM	Price per m/each
1093134	140	50	110	16	1	pce	75,56

Smatrix Base

Uponor Smatrix Base star module Pulse M-243 BUS 6X

- 6 channel star module for Uponor Smatrix Base controller Pulse X-245 Bus 6X
- Flexible wiring approaches possible (star topology)
- Supports up to 6 room thermostats
- Protection class: IP20
- Colour: white



Item No.	l mm	h mm	w mm	Pallet/ Pack	Box/M QTY	UOM	Price per m/each
1093135	140	50	110	16	1	pce	60,15

Uponor Smatrix Base thermostat style T-149 Bus D+ RH

- Measures and displays the perceived room temperature and relative humidity
- Protection class: IP30
- Colour: white RAL9016
- Functions:
 - Heating or cooling demand indication
 - RH measured value
 - Comfort / ECO indication
 - ECO setback modification
 - Manual H/C switchover function
 - Cooling allowed function (room by room)
 - Displays celsius or fahrenheit
 - Operating modes: room temperature (RT), internal with floor max/min (RFT), remote sensor (RS), remote outdoor (RO)
 - Temperature calibration
 - Optional: floor sensor can be connected
- Consisting of:
 - Uponor Smatrix Base thermostat D+RH Style T-149 Bus
 - Mounting set

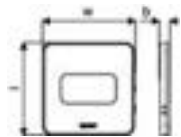

Item No.	l mm	b mm	h mm	w mm	Pallet/ Pack	Box/M QTY	UOM	Price per m/each
1087813	80	10	80		90	1	pce	150,66

Smatrix Base

Uponor Smatrix Base thermostat style T-149 Bus black D+ RH

- Measures and displays the perceived room temperature and relative humidity
- Protection class: IP30
- Colour: black
- Functions:
 - Heating or cooling demand indication
 - RH measured value
 - Comfort / ECO indication
 - ECO setback modification
 - Manual H/C switchover function
 - Cooling allowed function (room by room)
 - Displays celsius or fahrenheit
 - Operating modes: room temperature (RT), internal with floor max/min (RFT), remote sensor (RS), remote outdoor (RO)
 - Temperature calibration
 - Optional: floor sensor can be connected
- Consisting of:
 - Uponor Smatrix Base thermostat D+RH T-149 Bus
 - Mounting material

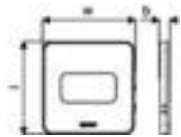

Item No.	l mm	h mm	w mm	Pallet/ Pack	Box/M QTY	UOM	Price per m/each
1087814	80	10	80	90	1	pce	165,89

Uponor Smatrix Base thermostat T-148 Bus P+RH

- Measures and displays the perceived room temperature and relative humidity
- Protection class: IP30
- Colour: white glossy
- Functions:
 - Heating or cooling demand indication
 - RH limit indication
 - Individual night setback
 - Set time start up wizard
 - 6 pre-programmed schedules
 - 1 freely programmable schedule
 - Cooling allowed function (room by room)
 - Displays celsius or fahrenheit
 - Operating modes: room temperature (RT), internal with floor max/min (RFT), remote sensor (RS), remote outdoor (RO)
 - display with backlight (dims 10 seconds after last button event)
 - Displays software version (on power-up)
 - Optional: floor or outdoor sensor can be connected
- Consisting of:
 - Uponor Smatrix Base thermostat Prog.+RH T-148 Bus
 - Mounting set



Item No.	Dimensions	l mm	h mm	w mm	Pallet/ Pack	Box/M QTY	UOM	Price per m/each
1086977	RAL9016	80	25	80	75	1	pce	89,93

Smatrix Base

Uponor Smatrix Base thermostat T-145 Bus POD standard

- Measures perceived room temperature
- Protection class: IP30
- Color: white glossy

Functions:

- Light indication behind dial after changing the set point
- Heating/cooling demand indication
- Dip switch to enable/disable timer function if timer installed
- Optional: enable/disable timer function

Consisting of:

- Uponor Smatrix Base thermostat standard T-145 Bus POD
- Mounting set



Item No.	Dimensions	l mm	h mm	w mm	Pallet/ Pack	Box/M QTY	UOM	Price per m/each
1086975	RAL9016	80	25	80	75	1	pce	43,02

Uponor Smatrix Base thermostat T-143 Bus public

- Measures perceived room temperature
- Protection class: IP30
- Colour: white glossy

Functions:

- Potentiometer on rear side to adjust setpoint temperature
- Tamper detector
- Dry contact input for forced ECO via e.g. SMS module or BMS
- Dry contact input for heating/cooling changeover
- Dip switch for function/sensor selection
- Optional: floor, outdoor or remote sensor can be connected

Consisting of:

- Uponor Smatrix Base thermostat public T-143 Bus
- Mounting set



Item No.	Dimensions	l mm	h mm	w mm	Pallet/ Pack	Box/M QTY	UOM	Price per m/each
1086972	RAL9016	80	25	80	75	1	pce	42,21

Uponor Smatrix Base wallframe Style T-149 A-14X

- T-149 surface adaptor for on-wall installation
- Incl. mounting material
- Colour: white RAL9016



Item No.	l mm	b mm	h mm	k mm	k1 mm	k2 mm	w mm	Pallet/ Pack	Box/M QTY	UOM	Price per m/each
1087821	77		11				77	90	1	pce	6,34

Smatrix Base

Uponor Smatrix Base wallframe style T-149 A-14x black

- T-149 surface adaptor for on-wall installation
- Incl. mounting set
- Colour: black

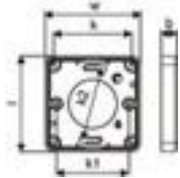

Item No.	l mm	b mm	h mm	k mm	k1 mm	k2 mm	w mm	Pallet/ Pack	Box/M QTY	UOM	Price per m/each
1087822	77		11				77	90	1	pce	6,01

Uponor Smatrix Base bus cable A-145

- 4-wire bus cable allows to connect Uponor Smatrix Base / Base PRO devices
- 2 wires for power supply / 2 wires for data transmission
- Shielding: aluminium/polyester foil with tracer strand
- Temperature range: -20°C - +80°C
- Cross section: AWG22
- Sheath: PVC
- Rated voltage: 400VAC/DC



Item No.	Dimensions	l mm	h mm	w mm	Pallet/ Pack	Box/M QTY	UOM	Price per m/each
1071670	50m	200	170	200	2	1	pce	192,71

Uponor Smatrix Base slave module M-140 Bus

- 6 channel slave module for Uponor Smatrix Base controller X-145 Bus 6X and Uponor Smatrix Base PRO controller X-147
- Bus 6X and Uponor Smatrix Base pro controller X-148 Modbus RTU
- Supports up to 6 room thermostats and 6 actuators
- Click-in installation
- Protection class: IP20
- Colour: grey



Item No.	Dimensions	l mm	h mm	w mm	Pallet/ Pack	Box/M QTY	UOM	Price per m/each
1071686	6x	165	55	110	16	1	pce	80,12

Uponor Smatrix Base star module M-141 Bus

- 6 channel star module for Uponor Smatrix Base controller X-145 Bus 6X and Uponor Smatrix Base PRO controller X-147 Bus 6X
- Flexible wiring approaches possible (star topology)
- Supports up to 6 room thermostats
- Protection class: IP20
- Colour: grey



Item No.	Dimensions	l mm	h mm	w mm	Pallet/ Pack	Box/M QTY	UOM	Price per m/each
1071651	8X	165	55	110	16	1	pce	63,10

Smatrix Base

Uponor Smatrix Base timer I-143 Bus

- Set time start up wizard
- Holiday mode
- Comfort/ECO indication
- Manual H/C switchover function
- 6 pre-programmed schedules
- 1 freely programmable schedule
- ECO setback value setting
- Clock reset
- Timer functions
- Autobalancing de-/activation
- Backlight
- Displays software version on start-up
- Protection class: IP30
- Colour: white glossy

Consisting of:

- Uponor Smatrix Base timer I-143 Bus
- Mounting material



Item No.	In/Out	Dimensions	l mm	h mm	w mm	Pallet/ Pack	Box/M QTY	UOM	Price per m/each
1086978	12.34	RAL9016	80	25	80	75	1	pce	61,93

Compatible with:

Item No.	Dimension	Pallet/ Pack	Box/M QTY	UOM	Price per m/each
1093030	Uponor Smatrix Pulse com R-208	16	1	pce	504,29
1087812	Uponor Smatrix Base PRO room sensor RH style T-141 Bus flush	90	1	pce	75,50
1144965	Uponor Smatrix wallframe T-2XY A-2XX	250	1	pce	5,01
1071684	Uponor Smatrix floor/remote sensor S-1XX	63	1	pce	13,16
1086986	Uponor Smatrix wallframe T-X A-1XX RAL9016	250	1	pce	4,71
1083576	Uponor Smatrix relay module H/C M-1XX 24V	84	1	pce	80,64
1083577	Uponor Smatrix relay module H/C M-1XX 230V	16	1	pce	121,78
1141677	Uponor Vario actuator NC FT 24V 1W IP54	100	1	pce	46,10
1141680	Uponor Vario retrofit actuator NC FT 230V 1W IP54	100	1	pce	44,63
1141681	Uponor Vario retrofit actuator NC FT 24V 1W IP54	100	1	pce	43,36
1141678	Uponor Vario PLUS actuator NC MT 230V 1W IP54	100	1	pce	50,65
1141679	Uponor Vario PLUS actuator NC MT 24V 1W IP54	100	1	pce	60,32

Smatrix Base PRO



Uponor Smatrix Base PRO, featuring Autobalancing technology, is an easy to use, intelligent room control system.

Smatrix Base PRO is available for integration into KNX or BMS Modbus RTU, but also as stand-alone solution with user friendly touch screen.

Specification

- Autobalancing optimizing energy use and comfort
- Up to 6 room thermostats and 8 actuators (24V) per controller; 6 channel expansion module option (with M-140)

Smatrix Base PRO controller X-147 with optional touch screen I-147 and KNX option

- Up to 16 controller in one system
- Daisy chain wiring or star wiring (with M-141)
- Optional: display for controller information and settings (with I-147)
- Optional: BMS integration via KNX interface (with R-147 and I-147)

Comfort settings comprises (with I-147)

- Temperature setback programs for each channel
- Max/min temperature limitations and relative humidity control
- Holiday settings and automatic summer/winter change
- Room bypass function
- Advance cooling settings and automatic summer/winter change
- Trend visualization (set point vs. room temperature, etc.)
- Accessories configuration
- Room check function and system diagnostic

Smatrix Base PRO controller X-148 Modbus RTU

Read data points

- Temperature: outdoor / room / floor
- Humidity level
- Status of: actuator / pump / boiler / general purpose input (GPI)
- Connection status of thermostat
- Dynamic heat curve offset in integrated heat pump

Read and write data points

- Room setpoint
- Min/max levels for: setpoint / floor temperature
- Settings: comfort/eco and autobalancing on/off
- Heating/cooling: state / offset
- Cooling not allowed for a room
- Integrated heat pump defrost state

Benefits

- Can be used for both radiant heating and cooling
- No manual balancing required
- Fast installation
- Simple end user control
- Stand alone, Modbus and KNX integration
- Pump and boiler relays
- Valve and pump exercise

Application

- Wired room temperature control for radiant heating and cooling
- Set point range: +5°C - +35°C

Certification

- CE, EAC

Smatrix Base PRO

Uponor Smatrix Base PRO controller X-147 Bus

- Supports up to 6 room thermostats and 8 actuators
- Option to extend up to 12 room thermostats and 14 actuators with 1071686
- Max. power input per actuator: 24VAC / 0.2A (0.4A peak)
- Protection class: Class II IP20
- Colour: grey RAL7015

Consisting of:

- Uponor Smatrix Base PRO controller X-147 Bus 6X
- Quick set-up guide, security instructions
- Micro SD card (pre-inserted)
- DIN rail (length: 37cm)
- Mounting material



Item No.	Dimensions	l mm	h mm	w mm	Pallet/ Pack	Box/M QTY	UOM	Price per m/each
1087162	6x	336	55	110	4	1	pce	328,45

Uponor Smatrix Base PRO controller X-148 Modbus RTU

- Suited for Modbus RTU systems
- Supports up to 6 room thermostats and 8 actuators with option to extend to 12 room thermostats and 14 actuators (use 1071686)
- Contains data points for heat pump integration
- Max. power input per actuator: 24VAC / 0.2A (0.4A peak)
- Protection class: Class II IP20

Consisting of:

- Uponor Smatrix Base PRO controller X-148 Modbus RTU
- Quick set-up guide, security instructions
- DIN rail (length: 37cm)
- Mounting material



Item No.	l mm	h mm	w mm	Pallet/ Pack	Box/M QTY	UOM	Price per m/each
1120013	336	55	110	4	1	pce	598,61



Uponor Smatrix Base PRO interface I-147 Bus

- Spare part touch panel for Uponor Smatrix Base controller X-147 Bus 6X
- Protection class: Class II IP20
- Colour: white RAL9016

Consisting of:

- Uponor Smatrix Base PRO interface I-147
- Power supply
- Mounting set
- Wall bracket
- Instruction leaflet



Item No.	l mm	h mm	w mm	Pallet/ Pack	Box/M QTY	UOM	Price per m/each
1087161	150	45	110	7	1	pce	417,28

Smatrix Base PRO

Uponor Smatrix Base PRO room sensor RH style T-141 Bus flush

- Room temperature and relative humidity sensor (flush mounted)
- Protection class: IP30
- Colour: white RAL9016

Consisting of:

- Uponor Smatrix Base PRO room sensor+RH Style T-141 Bus
- Mounting set



Item No.	l mm	h mm	w mm	Pallet/ Pack	Box/M QTY	UOM	Price per m/each
1087812	55	9	55	90	1	pce	75,50

Uponor Smatrix Base PRO gateway module R-147 KNX

- Connects a Uponor Smatrix Base PRO controller X-147 with a BMS or third-party KNX devices
- Power supply: 230VAC (+10%/-15%) / 50/60Hz
- Internal fuse: T5 F3.15AL 250V, 5x20 3.15A quick acting
- Operating temperature: 0°C - +45°C
- Storage temperature: -20°C - +70°C
- Max. consumption: 45W
- Power connection: 1m cable with Europlug
- Connection terminals for system bus: 0.2mm² - 1.5mm²
- Protection class: IP20 II

Functions:

- Room temperature from Uponor Base or third-party KNX thermostats
- Room setpoint from Uponor Base or third-party KNX thermostats
- Room relative humidity from Uponor Base or third-party KNX thermostats
- Room floor temperature from Uponor Base or third-party KNX thermostats
- Actuator status from Uponor Base or third-party KNX system
- Forced ECO from Uponor Base PRO or third-party KNX system
- Pump output from Uponor Base or third-party KNX system
- Boiler output from Uponor Base or third-party KNX system
- Heating/cooling curve settings/circuit from Uponor Move PRO to BMS or vice versa
- Heating/cooling modes from Uponor Base PRO to BMS or vice versa

Consisting of:



















- Gateway module R-147 KNX
- Power supply
- Mounting set (2 screws and 2 wall plugs)
- Quick guide



Item No.	l mm	h mm	w mm	Pallet/ Pack	Box/M QTY	UOM	Price per m/each
1087164	17,5	60	90		1	pce	551,16

Smatrix Base PRO

Compatible with:

Item No.	Dimension	Pallet/ Pack	Box/M QTY	UOM	Price per m/each
 1071686	Uponor Smatrix Base slave module M-140 Bus 6x	16	1	pce	80,12
 1071651	Uponor Smatrix Base star module M-141 Bus 8X	16	1	pce	63,10
 1087813	Uponor Smatrix Base thermostat style T-149 Bus D+ RH	90	1	pce	150,66
 1122237	Uponor Smatrix Base wallframe T-141 RAL9016	20	1	pce	4,59
 1144105	Uponor Smatrix Base thermostat D+RH T-247 BUS	75	1	pce	89,93
 1144965	Uponor Smatrix wallframe T-2XY A-2XX	250	1	pce	5,01
 1086978	Uponor Smatrix Base timer I-143 Bus RAL9016	75	1	pce	61,93
 1083576	Uponor Smatrix relay module H/C M-1XX 24V	84	1	pce	80,64
 1083577	Uponor Smatrix relay module H/C M-1XX 230V	16	1	pce	121,78
 1087814	Uponor Smatrix Base thermostat style T-149 Bus black D+ RH	90	1	pce	165,89
 1086975	Uponor Smatrix Base thermostat T-145 Bus POD standard RAL9016	75	1	pce	43,02
 1086972	Uponor Smatrix Base thermostat T-143 Bus public RAL9016	75	1	pce	42,21
 1071670	Uponor Smatrix Base bus cable A-145 50m	2	1	pce	192,71
 1087821	Uponor Smatrix Base wallframe Style T-149 A-14X	90	1	pce	6,34
 1087822	Uponor Smatrix Base wallframe style T-149 A-14x black	90	1	pce	6,01
 1086986	Uponor Smatrix wallframe T-X A-1XX RAL9016	250	1	pce	4,71
 1141677	Uponor Vario actuator NC FT 24V 1W IP54	100	1	pce	46,10
 1141681	Uponor Vario retrofit actuator NC FT 24V 1W IP54	100	1	pce	43,36
 1141679	Uponor Vario PLUS actuator NC MT 24V 1W IP54	100	1	pce	60,32

Smatrix Wave



The Smatrix Wave radio control system includes Autobalancing technology as well as other energy-efficient features for radiant heating and cooling systems.

Smatrix Wave also enables remote access and control through the Smatrix App. The end user has the ability to make changes remotely.

Specification

- up to 4 controller in one system
- operating voltage: 230V
- autobalancing optimises energy use and comfort
- electric control
- supports up to 6 room thermostats and 8 actuators (24V) per controller
- pump and boiler relays
- valve and pump exercise
- relative humidity control
- combines underfloor heating/cooling and ceiling cooling control
- max. power input per actuator: 24VAC / 0.2A (0.4A peak)

Smatrix Wave Pulse:

- local access (Wi-Fi) or remote access (internet connection re-quired) via Uponor Smatrix Pulse App (with R-208)
- temporary wi-fi access point for direct access (if local wi-fi is not available) (with R-208)
- smart home ecosystem integration (Amazon Alexa, Google Home) (with R-208)
- multi-home control (with R-208)
- third-party access for remote support (user allowance requi-red) (with R-208)
- history trend analysis via Uponor Smatrix Pulse app (with R-208)
- timer programming (with R-208)
- comfort settings (with R-208)
- supply diagnostics (with R-208)

Benefits

- Optional remote access via Smatrix App
- No manual balancing required
- Fast installation, minimal wiring
- Simple, intuitive end user control
- Wide range of energy efficiency features

Application

- Wireless room temperature control for radiant heating and cooling
- Set point range: +5°C - +35°C

Certification

- CE / EAC

Smatrx Wave

Uponor Smatrix Wave controller Pulse X-265 6X

- Compatible to Uponor Smatrix Wave controller Pulse X-265 6X
- Protection class: Class II IP20
- Colour: white

Consisting of:

- Uponor Smatrix Wave controller Pulse X-265 6X
- Uponor Smatrix Wave antenna Pulse A-265
- First step instructions, safety instructions
- Mounting set



Item No.	Dimensions	l mm	h mm	w mm	Pallet/ Pack	Box/M QTY	UOM	Price per m/each
1093022	UK	370	50	110	4	1	pce	359,84

Uponor Smatrix Wave slave module Pulse M-262 6X

- 6 channel slave module for Uponor Smatrix Wave controller Pulse X-265 6X
- Supports up to 6 room thermostats and 6 actuators
- Click-in installation
- Protection class: IP20
- Colour: white



Item No.	l mm	h mm	w mm	Pallet/ Pack	Box/M QTY	UOM	Price per m/each
1093133	140	50	110	16	1	pce	103,87

Uponor Smatrix Wave antenna Pulse A-265

- Spare part antenna for Uponor Smatrix Wave controller Pulse X-265 6X
- Cable length: 3m
- Plug: RJ45
- Colour: white

Consisting of:

- Uponor SPI Smatrix Wave antenna Pulse A-265 (incl. fixed connection cable)
- Mounting set



Item No.	l mm	h mm	w mm	Pallet/ Pack	Box/M QTY	UOM	Price per m/each
1093028	110	9	30	16	1	pce	70,46

Uponor Smatrix Wave relay module M-161 UK

- UK version
- Dual output receiver for Uponor Smatrix Wave controller or Uponor Smatrix Wave controller Pulse



Item No.	Dimensions	l mm	h mm	w mm	Pallet/ Pack	Box/M QTY	UOM	Price per m/each
1071658	2x	170	27	47	16	1	pce	108,78

Smatrix Wave

Uponor Smatrix Wave thermostat style T-169 D+ RH

- Measures and displays the perceived room temperature and relative humidity
- Colour: white RAL 9016

Functions:

- Heating or cooling demand indication
- RH measured value
- Comfort / ECO indication
- ECO setback modification
- Manual H/C switchover function
- Cooling allowed function (room by room)
- Displays celsius or fahrenheit
- Operating modes: room temperature (RT), internal with floor max/min (RFT), remote sensor (RS), remote outdoor (RO)
- Low battery indication
- Temperature calibration
- Optional: floor, remote or outdoor sensor can be connected

Consisting of:

- Uponor Smatrix Wave thermostat D+RH Style T-169
- 1x CR2032 battery
- Mounting set



Item No.	l mm	b mm	h mm	w mm	Pallet/ Pack	Box/M QTY	UOM	Price per m/each
1087816	80		10	80	90	1	pce	160,80

Uponor Smatrix Wave thermostat style T-169 black D+ RH

- Measures and displays the perceived room temperature and relative humidity
- Color: black

Functions:

- Heating or cooling demand indication
- RH measured value
- Comfort / ECO indication
- ECO setback modification
- Manual H/C switchover function
- Cooling allowed function (room by room)
- Displays celsius or fahrenheit
- Operating modes: room temperature (RT), internal with floor max/min (RFT), remote sensor (RS), remote outdoor (RO)
- Low battery indication
- Temperature calibration
- Optional: floor, remote or outdoor sensor can be connected

Consisting of:

- Uponor Smatrix Wave thermostat D+RH Style T-169
- 1x CR2032 battery
- Mounting set



Item No.	l mm	b mm	h mm	w mm	Pallet/ Pack	Box/M QTY	UOM	Price per m/each
1087817	80		10	80	90	1	pce	162,47

Smatrix Wave

Uponor Smatrix Wave room sensor RH Style T-161

- Room temperature and relative humidity sensor (flush mounted)
- Operating distance: max. 30m
- Protection class: IP30
- Colour: white RAL9016

Content:

- Uponor Smatrix Wave room sensor + RH Style T-161
- 1x CR2032 battery
- Mounting material



Item No.	l mm	b mm	h mm	w mm	Pallet/ Pack	Box/M QTY	UOM	Price per m/each
1087815	55	9	55		90	1	pce	90,22

Uponor Smatrix Wave thermostat T-168 P+RH

- Measures and displays the perceived room temperature and relative humidity
- Colour: white glossy

Functions:

- Heating or cooling demand indication
- RH limit indication
- Individual night setback
- Set time start up wizard
- 6 pre-programmed schedules
- 1 freely programmable schedule
- Manual H/C changeover function (available with Uponor Smatrix Move only)
- Cooling function allowed (room by room)
- Displays celsius or fahrenheit
- Operating modes: room temperature (RT), internal with floor max/min (RFT), remote sensor (RS), remote outdoor (RO)
- Backlight (dims 10 seconds after last button event)
- Displays software version (on power-up)
- Low battery indication
- Compatible with Uponor Smatrix Move supply cont. X-157 Wired (1071693)
- Optional: floor or outdoor sensor can be connected

Consisting of:

- Uponor Smatrix Wave thermostat prog.+RH T-168
- 2x AAA batteries
- Mounting set



Item No.	Dimensions	l mm	h mm	w mm	Pallet/ Pack	Box/M QTY	UOM	Price per m/each
1086984	RAL9016	80	25	80	75	1	pce	115,00

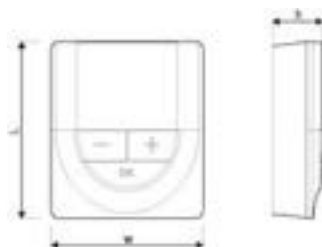

Smatrix Wave

Uponor Smatrix Wave thermostat D+RH T-267

- Measures and displays the room temperature and relative humidity
- Compatible with controllers Smatrix Wave Pulse (X-265) and Smatrix Wave (X-165)
- Colour: white RAL9016

Functions:

- Capacitive keys on the front
- Heating or cooling demand indication
- RH measured value
- Comfort / ECO indication
- ECO setback modification
- Cooling function allowed (room by room)
- Displays celsius or fahrenheit
- Operating modes: room temperature (RT), internal with floor max/min (RFT), remote sensor (RS), remote outdoor (RO)
- Low battery indication
- Room Temperature calibration
- Optional: floor, remote, or outdoor sensor can be connected

Consisting of:

- Uponor Smatrix Wave thermostat D+RH T-267
- 2x AAA batteries
- Thermometer stand
- Mounting set



Item No.	In/Out	L mm	W mm	H mm	W kg	Pallet/ Pack	Box/M QTY	UOM	Price per m/each
1144106	04.25	86	86	21	0,087	75	1	pce	91,12

Uponor Smatrix Wave thermostat T-165 POD standard

- Measures perceived room temperature
- Protection class: IP30
- Colour: white glossy

Functions:

- Light indication behind dial after changing the set point
- Heating/cooling demand indication
- Dip switch to enable/disable timer function if timer installed
- Optional: enable/disable timer function

Consisting of:

- Uponor Smatrix Wave thermostat standard T-165 POD
- 2x AAA batteries
- Mounting set



Item No.	Dimensions	l mm	h mm	w mm	Pallet/ Pack	Box/M QTY	UOM	Price per m/each
1086981	RAL9016	80	25	80	75	1	pce	70,32

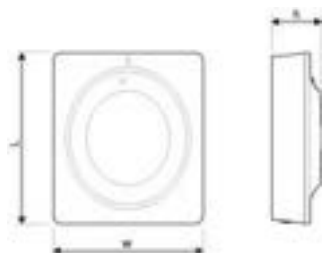

Smatrix Wave

Uponor Smatrix Wave thermostat T-163 public

- Measures perceived room temperature
- Protection class: IP30
- Colour: white glossy

Functions:

- Light indication behind dial after changing the set point
- Heating/cooling demand indication
- Dip switch to enable/disable timer function if timer installed
- Optional: enable/disable timer function

Consisting of:

- Uponor Smatrix Wave thermostat standard T-165 POD
- 2x AAA batteries
- Mounting set



Item No.	Dimensions	l mm	h mm	w mm	Pallet/ Pack	Box/M QTY	UOM	Price per m/each
1086979	RAL9016	80	25	80	75	1	pce	68,28

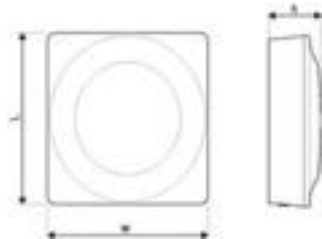

Uponor Smatrix Wave thermostatic head T-162

- Digital thermostat with actuator for radiator control
- Valve compatibility (Danfoss, Heimeier, Honeywell, Siemens, Sauter, etc.)
- Colour: glossy white

Functions:

- Comfort/ECO settings
- Weekly programmable
- Holiday mode
- Antifreeze program
- Boost function
- Backlight
- Optional: automatic summer/winter clock

Consisting of:









- Uponor Smatrix Wave thermostatic head T-162
- 2x AA batteries
- Different adaptors
- Manual



Item No.	l mm	h mm	w mm	Pallet/ Pack	Box/M QTY	UOM	Price per m/each
1071660	85	55	50	16	1	pce	145,60

Smatrix Wave

Compatible with:

Item No.	Dimension	Pallet/ Pack	Box/M QTY	UOM	Price per m/each
 1093030	Uponor Smatrix Pulse com R-208	16	1	pce	504,29
 1144965	Uponor Smatrix wallframe T-2XY A-2XX	250	1	pce	5,01
 1086986	Uponor Smatrix wallframe T-X A-1XX RAL9016	250	1	pce	4,71
 1071684	Uponor Smatrix floor/remote sensor S-1XX	63	1	pce	13,16
 1083576	Uponor Smatrix relay module H/C M-1XX 24V	84	1	pce	80,64
 1083577	Uponor Smatrix relay module H/C M-1XX 230V	16	1	pce	121,78
 1141677	Uponor Vario actuator NC FT 24V 1W IP54	100	1	pce	46,10
 1141681	Uponor Vario retrofit actuator NC FT 24V 1W IP54	100	1	pce	43,36
 1141679	Uponor Vario PLUS actuator NC MT 24V 1W IP54	100	1	pce	60,32

Smatrix Move



Benefits

- Comfort and Eco programming schedule
- Real time status information
- Pump logic for both stand-alone, and in combination with Uponor room controls
- Optional secondary heating/hot water circuit control

Uponor Smatrix Move is an intelligent water supply temperature controller for heating systems.

Smatrix Move optimises supply water temperature by adjusting the setpoint based on measured outdoor or indoor temperatures. A choice of compensation modes is available to provide optimal performance and energy efficiency.

Specification

- Comfort and Eco programming schedule
- Real-time status information
- Pump logic for both stand-alone, and in combination with Uponor room temperature controls
- Multiple compensation modes
- Optional: secondary heating/hot water circuit control
- Optional: snow melt add-on
- Optional: condensation protection

Application

- supply water temperature control

Certification

- CE

Uponor Smatrix Move mixer motor 3 point 230V

- 3-point control
- For Uponor Smatrix Move controller



Item No.	In/Out	l mm	h mm	w mm	Pallet/ Pack	Box/M QTY	UOM	Price per m/each
1002357	12.34	120	83	85		1	pce	369,52

Uponor Smatrix Move antenna A-155 Radio

- Sparepart antenna for Uponor Smatrix Move controller
- Allows wireless connection to Uponor Smatrix Wave thermostats

Content:

- Uponor Smatrix Move antenna
- Connection cable
- Mounting set
- Additional conformity: EAC



Item No.	In/Out	l mm	h mm	w mm	Pallet/ Pack	Box/M QTY	UOM	Price per m/each
1071676	12.34	220	6	20	21	1	pce	70,84

Smatrix Move

Uponor Smatrix Move supply cont. X-157 Wired

- Supply water temperature controller
- Control mode: heating only
- Control principle: outdoor temperature compensation

Functions:

- Mixing valve activation
- Weekly program with 9 pre-programmed schedules
- 4 freely programmable schedules
- Pump logic as stand alone
- Pump logic in combination with Uponor Smatrix Base or Wave controller
- Real time information of supply, outdoor and room temperature
- Real time information of mixing valve status
- Real time information of current day shown in a graph (comfort and reduced temperature)

Options:

- DHW production and boiler control
- HW heating circuit
- Up to 100°C supply water control
- 2 powered general purpose outputs
- 2 general purpose inputs
- Security contact thermostat
- 230V mixer motor

Content:

- Uponor Smatrix Move controller H
- Supply/return sensor
- Outdoor sensor
- Protection class: IP30 II
- Colour: dark grey



Item No.	l mm	h mm	w mm	Pallet/ Pack	Box/M QTY	UOM	Price per m/each
1071693	160	45	85	4	1	set	357,33

Uponor Smatrix Move supply/return sensor S-152

- Supply/return sensor
- Measures supply or return temperature
- Sensor type: NTC 10 kΩ at 25 °C
- Length: 3m
- Protection class: IP68 II



Item No.	Dimensions	l mm	h mm	w mm	Pallet/ Pack	Box/M QTY	UOM	Price per m/each
1071661	3m	60	30	60	63	1	pce	35,43

Smatrix Move

Uponor Smatrix Move outdoor sensor S-1XX

- Measures outdoor temperature
- Incl. mounting set
- Can be combined with Uponor Smatrix Wave/Move controllers
- Optional wireless connection, if combined with Uponor Smatrix Wave Thermostat Public
- Protection class: IP55
- Sensor type: NTC 10kOhm at 25°C
- Colour: light grey



Item No.	l mm	h mm	w mm	Pallet/ Pack	Box/M QTY	UOM	Price per m/each
1071671	62	35	55	45	1	pce	43,61

Compatible with:

Item No.	Dimension	Pallet/ Pack	Box/M QTY	UOM	Price per m/each
1083576	Uponor Smatrix relay module H/C M-1XX 24V	84	1	pce	80,64
1083577	Uponor Smatrix relay module H/C M-1XX 230V	16	1	pce	121,78

Smatrix Move PRO



Benefits

- Multi application supply water temperature controller
- Simultaneous control up to 4 different supply water temperatures
- Intelligent auto heating/cooling switchover
- Selection of compensation modes
- Control snow/ice melting systems as well as turf heating

Uponor Smatrix Move PRO It's a flexible, "installer-friendly" and versatile multi-zone supply water controller.

Fits different scenarios covering indoor and outdoor applications, radiant heating and cooling, domestic hot water, etc. with one single controller.

Two different applications available, depending on SD card inserted: Heating only or Heating and Cooling.

Integration with Smatrix Base PRO room controls possible. BMS ready, via Modbus interface or R-147 KNX Gateway (together with Smatrix Base PRO only)

Specification

- Multi-zone supply water temperature controls
- Simultaneous control up to 4 different supply water temperatures
- Intelligent auto heating/cooling changeover
- Control snow/ice melting systems as well as turf heating
- Integration with Smatrix Base PRO room controls possible
- Optional connection to BMS via Modbus interface or R-147 KNX gateway (in combination with Smatrix Base PRO only)

Application

- Supply water
- Commercial buildings
- Indoor and outdoor systems
- Radiant heating and cooling
- Domestic hot water
- Heating only mode
- Heating and cooling

Certification

- CE

Smatrrix Move PRO

Uponor Smatrrix Move PRO room sensor S-155

- Room sensor
- Measures room temperature
- For indoor heating and cooling zones with indoor compensation
- 2-wire connection to Uponor Smatrrix Move PRO controller X-159
- Sensor type: NTC10
- Temperature range: 0°C - +60°C
- Protection class: IP20



Item No.	In/Out	l mm	b mm	h mm	w mm	Pallet/ Pack	Box/M QTY	UOM	Price per m/each
1087159	12.27	80	30	85		10	1	pce	84,31

Uponor Smatrrix Move PRO humidity sensor S-157

- Room sensor + RH
- Measures relative humidity for dew point calculations
- For cooling only and heating and cooling zones
- 3-wire connection to Uponor Smatrrix Move PRO controller X-159
- Humidity range: 0-100% non-condensing
- Accuracy: < 2% RH
- Operating voltage: 24V / 50-60 Hz
- Operating temperature: -10°C - +50°C
- Protection class: IP20



Item No.	In/Out	l mm	h mm	w mm	Pallet/ Pack	Box/M QTY	UOM	Price per m/each
1087160	12.27	80	25	80	75	1	pce	344,29

Compatible with:

Item No.	Dimension	Pallet/ Pack	Box/M QTY	UOM	Price per m/each
1071661	Uponor Smatrrix Move supply/return sensor S-152 3m	63	1	pce	35,43
1083576	Uponor Smatrrix relay module H/C M-1XX 24V	84	1	pce	80,64
1083577	Uponor Smatrrix relay module H/C M-1XX 230V	16	1	pce	121,78

Ecoflex Pre-Insulated Plastic Pipes For Heat & Water Distribution

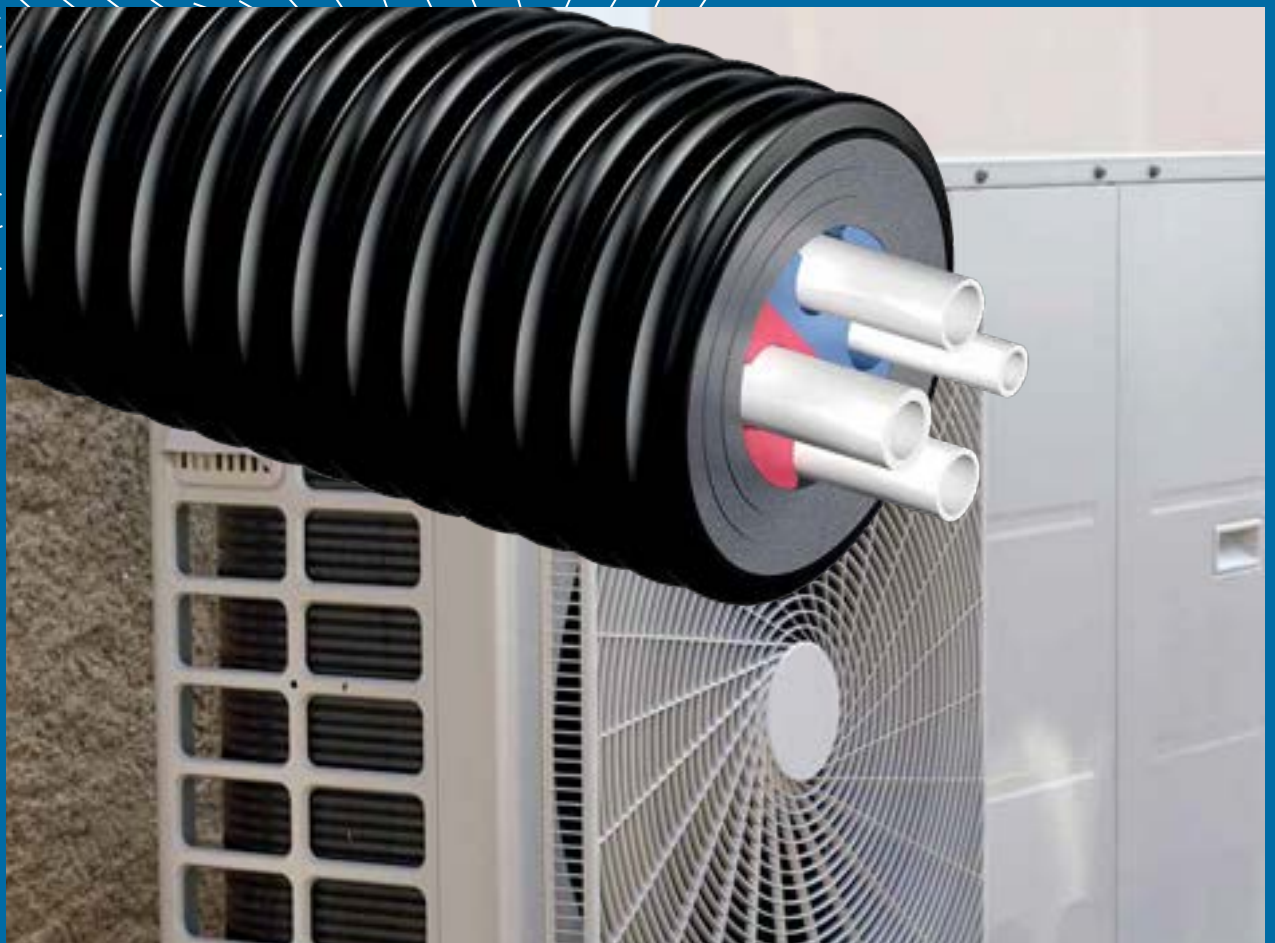

Ecoflex VIP Thermo

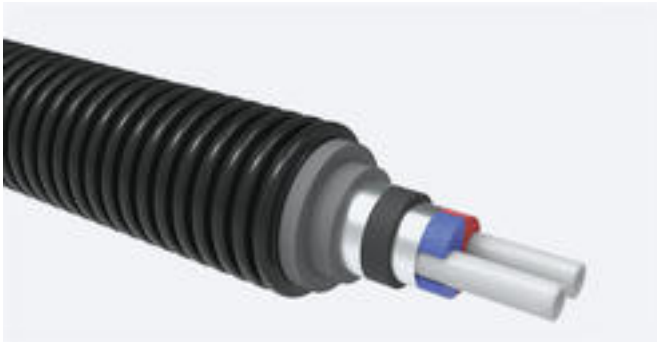

Uponor Ecoflex VIP Thermo pipe, uses highly efficient 'Vacuum Insulated Panel' technology to offers the highest levels of thermal insulation for heating and cooling applications.

Due to the exceptional thermal performance of the insulation, outer jacket sizes are kept to the minimum to ensure the least possible amount of groundworks, and to maintain the highest flexibility to allow easy installation.

Manufactured to European Standard BS EN 15632 for heating and BS EN 17414 for cooling applications, Ecoflex Thermo VIP is available in either single pipe systems, or in efficient twin pipe arrangements.

Specification

- Highest thermally efficient VIP (Vacuum Insulated Panel)
 λ 0.004 w*m/K
- Highest thermal resistance for complete insulation assembly
- Flexible, pre-insulated, self-compensating plastic pipe system manufactured to BS EN 15632 and BS EN 17414.
- Carrier pipe: cross-linked polyethylene (PE-Xa) pipe based on BS EN ISO 15875, natural Coloured, PN 6 (SDR 11)
- Oxygen tightness based on BS EN 15632 to ISO 17455 and DIN 4726
- Insulating material: Revolutionary VIP technology with extremely low lambda value in combination with permanently elastic closed-cell PE-X foam
- Casing pipe: UV stabilised, corrugated polyethylene (HDPE)

Benefits

- Next-generation, VIP pre-insulated pipe systems
- Outstanding thermal performance
- Revolutionary energy efficiency with cutting-edge Vacuum Insulated Panel (VIP) technology
- Smallest outer jacket sizes
- Superior flexibility
- Ease of installation
- Coil lengths of up to 200m, no need to add expensive connections
- Can be ordered in specified lengths

Application

- Ideal for low-carbon heating and cooling technologies
- Buried services for the transport of heating or cooling water.
- Heating operating temperature 80°C based on BS EN 15632
- Malfunction temperature 95°C
- Static verification for heavy traffic load of up to 60 tons

Certification

-

Ecoflex VIP Thermo

Uponor Ecoflex VIP Thermo Single

- Heating and Cooling
- Single PE-Xa carrier pipe with oxygen barrier, SDR 11
- Max. load 6 bar / 80°C
- VIP + PEX foam, HDPE casing

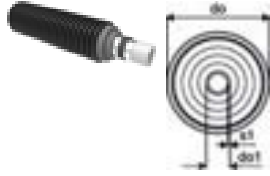

Item No.	In/Out	Dimensions	R m	do mm	do1 mm	s1 mm	W kg	Pallet/ Pack	Box/M QTY	UOM	Price per m/each
1095714		40x3,7/140	0,35	140	40	3,7	1,67		200	m	120,45
1095715		50x4,6/140	0,4	140	50	4,6	1,94		200	m	133,60
1095716		63x5,8/140	0,5	140	63	5,8	2,35		200	m	169,23
1095717		75x6,8/140	0,6	140	75	6,8	2,73		200	m	200,53
1160605	09.25	90X8,2/175	0,7	175	90	8,2	4,11		150	m	212,79
1160606	09.25	110X10,0/175	0,9	175	110	10	5,2		150	m	240,86
1095720		125x11,4/200	1,4	200	125	11,4	6,65		120	m	330,79
1121643	02.25	140x12,7/200	1,7	200	140	12,7	7,59		100	m	353,70
1121644	02.25	160x14,6/250	2,1	250	160	14,6	10,25		70	m	395,76

Uponor Ecoflex VIP Thermo Twin

- Heating and Cooling
- Twin PE-Xa carrier pipes with oxygen barrier, SDR 11
- Max. load 6 bar / 80°C
- Coloured centre profile to identify flow and return lines
- VIP + PEX foam, HDPE casing

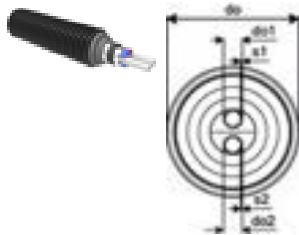

Item No.	In/Out	Dimensions	R m	do mm	do1 mm	do2 mm	s1 mm	s2 mm	W kg	Pallet/ Pack	Box/M QTY	UOM	Price per m/each
1118580		2x25x2,3/140	0,4	140	25	25	2,3	2,3	1,7		200	m	119,99
1118581		2x32x2,9/140	0,5	140	32	32	2,9	2,9	1,91		200	m	137,74
1160612	09.25	2X40X3,7/140	0,8	140	40	40	3,7	3,7	2,28		200	m	160,12
1160613	09.25	2X50X4,6/175	0,9	175	50	50	4,6	4,6	3,53		200	m	202,42
1160614	09.25	2X63X5,8/200	1,2	200	63	63	5,8	5,8	4,99		100	m	235,58
1160615	09.25	2X75X6,8/250	1,0	250	75	75	6,8	6,8	6,74		100	m	352,90

Ecoflex VIP Aqua



Benefits

- Hygienic
- Next-generation, flexible VIP pre-insulated pipe systems
- Outstanding thermal performance
- Revolutionary energy efficiency with cutting-edge Vacuum Insulated Panel (VIP) technology
- Smallest outer jacket sizes
- Superior flexibility
- Ease of installation
- Coil lengths of up to 200m, no need to add expensive connections
- Can be ordered in specified lengths

Uponor Ecoflex VIP Aqua pipe for the hygienic supply of warm tapwater, uses a highly efficient 'Vacuum Insulated Panel' technology to offer the highest levels of thermal insulation .

Due to the exceptional thermal performance of the insulation, outer jacket sizes are kept to the minimum to ensure the least possible amount of groundworks, and to maintain the highest flexibility to allow easy installation.

Ecoflex VIP Aqua is available in either a single pipe system for large capacity or for when one supply line is sufficient, or in efficient twin pipe arrangements for when recirculation systems are necessary.

Specification

- Flexible, pre-insulated, self-compensating plastic pipe system.
- Medium pipe: cross-linked polyethylene (PE-Xa) manufactured to BS EN ISO 15875, natural coloured, PN 10 (SDR 7,4)
- Insulating material: Revolutionary VIP technology with extremely low lambda value in combination with permanently elastic closed-cell PE-X foam.
- Casing pipe: UV stabilised, corrugated polyethylene (HDPE)
- Twin pipe: colour coded identification to identify supply and return lines

Application

- Buried installations for the transport of warm tap water
- Tap water operating temperature 70°C based on BS EN ISO 15875
- Malfunction temperature 95°C
- Static verification for heavy traffic load of 60 tons

Certification

UK Reg4 approval

- WRAS or
- KIWA

To meet the requirements of the Water Supply (Water Fittings) Regulations 1999

Uponor Ecoflex VIP Aqua Single

- Warm tap water
- One medium pipe PE-Xa, SDR 7,4
- Max. load 10 bar / 70°C
- VIP + PEX foam, HDPE casing

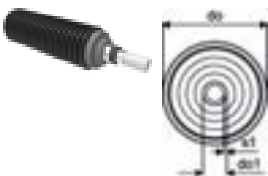

Item No.	In/Out	Dimensions	R m	do mm	do1 mm	s1 mm	W kg	Pallet/ Pack	Box/M QTY	UOM	Price per m/each
1119047		40x5,5/140	0,45	140	40	5,5	1,83		200	m	128,99
1119048		50x6,9/140	0,55	140	50	6,9	2,2		200	m	153,50
1119049		63x8,6/140	0,65	140	63	8,6	2,76		200	m	177,54
1119050		75x10,3/140	0,9	140	75	10,3	3,33		100	m	256,92
1160620	09.25	90X12,3/175	1,4	175	90	12,3	4,99		100	m	286,30
1160621	09.25	110X15,1/175	0,8	175	110	15,1	6,45		100	m	331,67

Ecoflex VIP Aqua

Uponor Ecoflex VIP Aqua Twin

- Warm tap water
- One medium pipe PE-Xa, SDR 7,4
- Max. load 10 bar / 70°C
- Coloured centre profile to identify flow and return lines
- VIP + PEX foam, HDPE casing

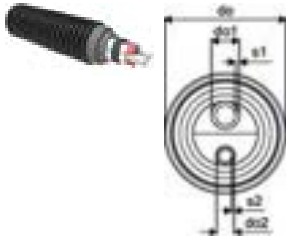

Item No.	Dimensions	R m	do mm	do1 mm	do2 mm	s1 mm	s2 mm	W kg	Pallet/ Pack	Box/M QTY	UOM	Price per m/each
1119053	25x3,5-20x2,8/140	0,65	140	25	20	3,5	2,8	1,74		200	m	106,11
1119054	32x4,4-20x2,8/140	0,7	140	32	20	4,4	2,8	1,88		200	m	118,54
1119055	40x5,5-25x3,5/140	0,9	140	40	25	5,5	3,5	2,18		200	m	156,48
1119056	50x6,9-32x4,4/175	1	175	50	32	6,9	4,4	3,36		200	m	176,46
1132671	63x8,6-40x5,5/200	1,1	200	63	40	8,6	5,5	4,87		100	m	205,26

Ecoflex Thermo

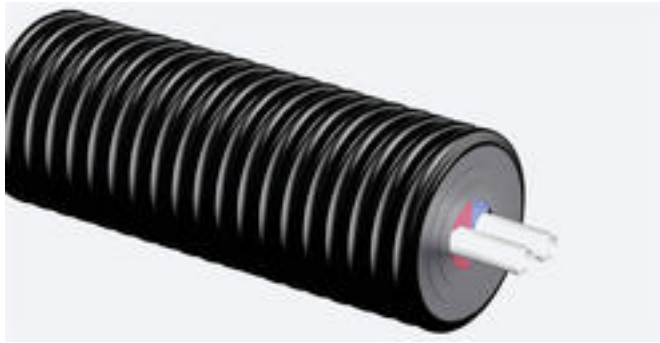

Benefits

- Cost efficient
- Excellent thermal performance
- Highly flexible pipe system
- Easy installation
- Coil lengths of up to 200m
- Can be ordered in specific cut lengths

Uponor Ecoflex Thermo system is intended for use with buried services for the supply of heating and cooling water.

Carrier pipes are manufactured from durable cross-linked PE-Xa to BS EN 15875. The flexible pipe system benefits from highly efficient PE-X insulation and is fully protected by the sturdy HDPE outer casing. Supply and return lines are easily identified by the colour coded centre profile.

Specification

- Heating and Cooling
- PE-Xa carrier pipe with oxygen barrier, SDR 11
- Max. load 6 bar / 80°C
- PEX foam, HDPE casing

Uponor Ecoflex Thermo Single

- Heating and cooling
- One carrier pipe PE-Xa, SDR 11
- Max. load 6 bar / 80°C
- PEX foam, HDPE casing



Application

- Buried services for the transport of heating or cooling water.
- Heating operating temperature 80°C based on BS EN 15632

Certification

-

Item No.	Dimensions	R m	do mm	do1 mm	s1 mm	W kg	Pallet/ Pack	Box/M QTY	UOM	Price per m/each
1018109	25x2,3/140	0,25	140	25	2,3	1,18		200	m	65,61
1018110	32x2,9/140	0,3	140	32	2,9	1,31		200	m	71,28
1018111	40x3,7/175	0,35	175	40	3,7	2,03		200	m	93,48
1018112	50x4,6/175	0,45	175	50	4,6	2,26		200	m	100,07
1018113	63x5,8/175	0,55	175	63	5,8	2,56		200	m	113,41
1018114	75x6,8/200	0,8	200	75	6,8	3,74		100	m	154,50
1018115	90x8,2/200	1,1	200	90	8,2	4,2		100	m	173,81
1018116	110x10,0/200	1,2	200	110	10	5,24		100	m	206,99

Ecoflex Thermo

Uponor Ecoflex Thermo Twin

- Heating and Cooling
- Two carrier pipes PE-Xa with oxygen barrier, SDR 11
- Max. load 6 bar / 80°C
- Coloured centre profile to identify flow and return lines
- PE-X foam, HDPE casing

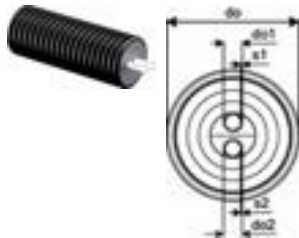

Item No.	Dimensions	R m	do mm	do1 mm	do2 mm	s1 mm	s2 mm	W kg	Pallet/ Pack	Box/M QTY	UOM	Price per m/each
1018134	2x25x2,3/175	0,5	175	25	25	2,3	2,3	1,92		200	m	89,93
1018135	2x32x2,9/175	0,6	175	32	32	2,9	2,9	1,99		200	m	102,26
1018136	2x40x3,7 /175	0,8	175	40	40	3,7	3,7	2,33		200	m	110,27
1018137	2x50x4,6/200	1	200	50	50	4,6	4,6	3,59		100	m	150,66
1018138	2x63x5,8/200	1,2	200	63	63	5,8	5,8	4,55		100	m	181,86

Uponor Ecoflex Thermo mini

- Heating and Cooling
- One medium pipe PE-Xa with oxygen barrier, SDR 11
- Max. load 6 bar / 80°C
- PEX foam, HDPE casing

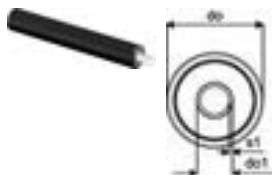

Item No.	Dimensions	R m	do mm	do1 mm	s1 mm	W kg	Pallet/ Pack	Box/M QTY	UOM	Price per m/each
1018132	25x2,3/68	0,2	68	25	2,3	0,5		200	m	46,58
1018133	32x2,9/68	0,25	68	32	2,9	0,55		200	m	53,98

Uponor Ecoflex Thermo Twin HP

- Point-to-point heat-pump connection pipe, heating and cooling
- Two PE-Xa carrier pipes with oxygen barrier, SDR 11
- Oxygen tightness to ISO 17455 and DIN 4726
- Two cable conduits for power and data cables
- Max. load 6 bar / 80°C
- Coloured centre profile to identify flow and return lines
- PEX foam, HDPE casing



Item No.	Dimensions	R m	do mm	do1 mm	do2 mm	s1 mm	s2 mm	W kg	Pallet/ Pack	Box/M QTY	UOM	Price per m/each
1093894	2x32x2,9-2x32x3,5/140	0,5	140	32	32	2,9	3,5	1,655		200	m	78,74
1093895	2x40x3,7-2x32x3,5/175	0,8	175	40	32	3,7	3,5	2,605		200	m	96,14
1137494	2x50x4,6+2x32x3,5/200	1	200	50	32	4,6	3,5	3,599		100	m	95,11
1137495	2x63x5,8+2x32x3,5/200	1	200	63	32	5,8	3,5	4,306		100	m	109,46

Ecoflex Thermo

Uponor Ecoflex Thermo connection set Twin HP

- Point-to-point heat-pump connection pipe, heating and cooling

- Set includes
- Ecoflex Thermo Twin HP heating pipe
- 2 Quattro rubber end caps
- 4 Wipex Couplings
- 30m of Trench warning tape
- Order on full pallet



Item No.	In/Out	Dimensions	W kg	Pallet/ Pack	Box/M QTY	UOM	Price per m/each
1105778		2x32x2,9-2x32x3,5/140 L=8m	22,8	4	1	set	651,33
1105779		2x32x2,9-2x32x3,5/140 L=12m	29,42	4	1	set	904,64
1161404	03.26	2x32x2,9-2x32x3,5/140 L=15M	27,52	3	1	set	997,11
1161405	03.26	2x32x2,9-2x32x3,5/140 L=20M	36,20		1	set	1 424,43
1105780		2x40x3,7-2x32x3,5/175 L=8m	31,5	3	1	set	904,64
1105781		2x40x3,7-2x32x3,5/175 L=12m	42,5	3	1	set	1 099,13
1161408	03.26	2x40x3,7-2x32x3,5/175 L=15M	43,85		1	set	1 638,79
1161409	03.26	2x40x3,7-2x32x3,5/175 L=20M	56,88		1	set	1 965,09
1161411	03.26	2x50x4,6-2x32x3,5/200 L=10M	41,64		1	set	1 692,61
1161413	03.26	2x50x4,6-2x32x3,5/200 L=20M	77,628		1	set	2 396,70

Uponor Ecoflex Thermo pipe connection set Twin HP

- For use with Ecoflex Thermo Twin HP pipe for connection of heat-pumps
- Connection set includes:
- 2 Quattro rubber end caps
- 4 Wipex Couplings
- 30m of Trench warning tape



Item No.	In/Out	Dimensions	W kg	Pallet/ Pack	Box/M QTY	UOM	Price per m/each
1118630		32x2,9/140	2,54		1	set	248,44
1118631		40x3,7/175	4,00		1	set	381,38
1161414	03.26	50x4,6/200	4,74		1	set	405,35
1185155	03.26	63x5,8/200	6,54		1	set	559,75

Uponor Ecoflex Cap for HP cable conduit

- Used to cap and protect 32mm HP conduit pipe
- Set includes:
- 2 rubber end caps
- 2 cable ties

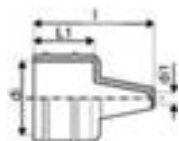

Item No.	In/Out	Dimensions	di mm	di1 mm	l1 mm	l mm	W kg	Pallet/ Pack	Box/M QTY	UOM	Price per m/each
1164764	NEW	32mm	32	4,85	25	49,7	0,026		1	set	5,47

Ecoflex Aqua

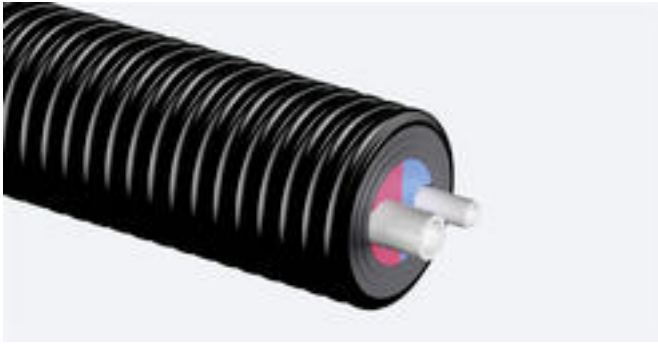

Benefits

- Hygienic
- Efficient closed cell PE-X insulation
- High thermal performance
- Smallest outer jacket sizes
- Superior flexibility
- Ease of installation
- Coil lengths of up to 200m, no need to add expensive connections
- Can be ordered in specified lengths

Uponor Ecoflex Aqua pipe for the hygienic supply of warm tapwater, uses an efficient PE-X closed cell insulation to offer excellent levels of thermal insulation.

Outer jacket sizes are kept to the minimum to ensure the least possible amount of groundworks, and to maintain the highest flexibility to allow easy installation.

Ecoflex Aqua is available in either a single pipe system for large capacity or for when one supply line is sufficient, or in efficient twin pipe arrangements for when recirculation systems are necessary.

Specification

- Flexible, pre-insulated, self-compensating plastic pipe system.
- Medium pipe: cross-linked polyethylene (PE-Xa) manufactured to BS EN ISO 15875, natural Coloured, PN 10 (SDR 7,4)
- Insulating material: Permanently elastic closed-cell PE-X foam.
- Casing pipe: UV stabilised, corrugated polyethylene (HDPE)
- Twin pipe: colour coded identification to identify supply and return lines

Application

- Transport of warm tap water for buried installations.
- Tap water operating temperature 70°C based on BS EN ISO 15875
- Malfunction temperature 95°C
- Static verification for heavy traffic load of 60 tons

Certification

UK Reg4 approval

- WRAS or
- KIWA

To meet the requirements of the Water Supply (Water Fittings) Regulations 1999

Uponor Ecoflex Aqua Single

- Warm tap water
- One medium pipe PE-Xa, SDR 7,4
- Max. load 10 bar / 70°C
- PEX foam, HDPE casing



Item No.	Dimensions	R m	do mm	do1 mm	s1 mm	W kg	Pallet/ Pack	Box/M QTY	UOM	Price per m/each
1018117	25x3,5/140	0,35	140	25	3,5	1,24		200	m	75,25
1018118	32x4,4/140	0,4	140	32	4,4	1,42		200	m	83,87
1018119	40x5,5/175	0,45	175	40	5,5	2,2		200	m	111,34
1018120	50x6,9/175	0,55	175	50	6,9	2,54		200	m	130,80
1018121	63x8,6/175	0,65	175	63	8,6	3		200	m	148,92

Ecoflex Aqua

Uponor Ecoflex Aqua Twin

- Warm tap water with circulation
- Two medium pipe PE-Xa, SDR 7,4
- Max. load 10 bar / 70°C
- PEX foam, HDPE casing
- Coloured centre profile to identify supply and return lines



Item No.	Dimensions	R m	do mm	do1 mm	do2 mm	s1 mm	s2 mm	W kg	Pallet/ Pack	Box/M QTY	UOM	Price per m/each
1018139	25x3,5-25x3,5/175	0,65	175	25	25	3,5	3,5	2,05		200	m	106,96
1018140	32x4,4-25x3,5/175	0,7	175	32	25	4,4	3,5	2,2		200	m	113,28
1018141	40x5,5-25x3,5/175	0,9	175	40	25	5,5	3,5	2,45		200	m	123,76
1018142	50x6,9-25x3,5/175	1	175	50	25	6,9	3,5	2,73		200	m	140,34

Ecoflex Quattro

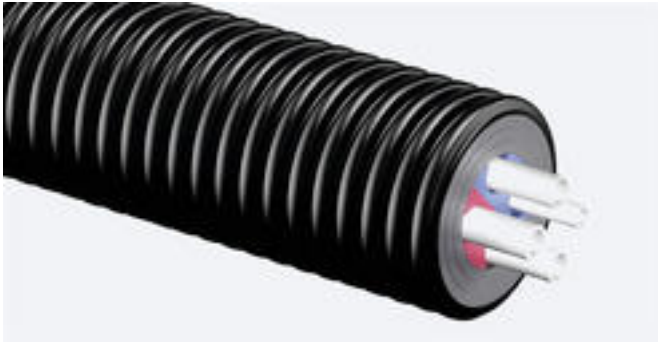

Benefits

- Cost efficient, all-in-one installation
- DHW and heating pipes in one assembly
- Energy efficient
- Excellent flexibility
- Ease of installation
- Corrosion resistant
- Coils up to 200m, no need for in-line connections
- Can be ordered in specified lengths

Uponor Ecoflex Quattro is an all-in-one pipe solution for the safe transport and distribution of DHW and heating in one pipe system.

By providing both heated water services in a single arrangement, Ecoflex Quattro is cost efficient, reduces the amount of groundworks necessary and is more thermally efficient than separate service pipes for each application.

Ecoflex Quattro provides heating and warm tap water supply - two flow pipes are intended for domestic warm water, with a suitably sized return pipe for recirculation, and the other two pipes are equivalent sized pipes for heating.

Specification

- Flexible, pre-insulated, self-compensating plastic pipe system
- Medium pipe: Cross-linked polyethylene (PE-Xa) pipe to BS EN ISO 15875, natural coloured, PN 6 (SDR 11) and PN10 (SDR 7,4)
- Oxygen tightness to ISO 17455 and DIN 4726
- Insulating material: closed-cell PE-X foam, permanently elastic, ageing-resistant
- Casing pipe: Corrugated polyethylene (HDPE)

Uponor Ecoflex Quattro

- Heating, and warm tap water with circulation
- Four PE-Xa carrier pipes, SDR 11 and 7,4
- Max. load 6 bar heating 80°C / 10 bar tap water 70°C
- Oxygen tightness to ISO 17455 and DIN 4726 (Heating)
- PEX foam, HDPE casing
- Coloured centre profile to identify supply and return lines



Application

- Buried services for the transport of heating or cooling water
- Heating operating temperature 80°C based on BS EN 15632
- Tap water operating temperature 70°C to BS EN ISO 15875
- Malfunction temperature 95°C
- Static verification for heavy traffic load of up to 60 tons

Certification

UK Reg4 approval (DHW)

- WRAS or
- KIWA

To meet the requirements of the Water Supply (Water Fittings) Regulations 1999

Item No.	Dimensions	R	do	do1	do2	do3	s1	s2	s3	W	Pallet/ Pack	Box/M QTY	UOM	Price per m/
1018147	2x25x2,3-2x25x3,5/175	0,8	175	25	25	25	2,3	3,5	3,5	2,41		200	m	152,63
1018148	2x32x2,9-2x25x3,5/175	0,8	175	32	25	25	2,9	3,5	3,5	2,64		200	m	167,56
1018149	2x32x2,9-32x4,4-25x3,5/175	0,8	175	32	32	25	2,9	4,4	3,5	2,78		200	m	175,21

Ecoflex Supra



Uponor Ecoflex Supra is designed for the supply of cold potable water, and for use with chilled water distribution for cooling systems.

Uponor Ecoflex Supra pipes are ideal to deliver cold water to single family and multi-family homes, hotels, schools, health-care, holiday resorts, hotel complexes or industrial facilities.

Specification

- Flexible, pre-insulated, self-compensating plastic pipe system
- Carrier pipe: Polyethylene PE100 RC, PN 16 (SDR 11) black with blue stripes
- Insulating material: Closed-cell PE-X foam, permanently elastic, ageing-resistant
- Casing pipe: Corrugated polyethylene (HDPE)

Uponor Ecoflex Supra

- Cold potable water and cooling
- One medium pipe PE 100 RC black, SDR 11
- Max. load 16 bar / 20°C
- PEX foam, HDPE casing



Item No.	Dimensions	R m	do mm	do1 mm	s1 mm	W kg	Pallet/ Pack	Box/M QTY	UOM	Price per m/each
1095722	25x2,3/68	0,3	68	25	2,3	0,52		200	m	40,85
1095723	32x2,9/68	0,4	68	32	2,9	0,62		200	m	43,43
1095724	40x3,7/140	0,5	140	40	3,7	1,47		200	m	91,38
1095725	50x4,6/140	0,6	140	50	4,6	1,67		200	m	95,99
1095726	63x5,8/140	0,7	140	63	5,8	1,97		200	m	104,34
1095727	75x6,8/175	0,9	175	75	6,8	2,72		150	m	108,40
1095728	90x8,2/175	1	175	90	8,2	3,14		100	m	106,51
1095729	110x10,0/200	1,2	200	110	10	5,24		100	m	146,77

Benefits

- Coil lengths up to 200m
- No need for in-line connections
- Excellent flexibility
- Ease of installation
- Clean and hygienic
- Corrosion resistant
- Can be ordered in specified lengths

Application

- Transport of cold potable or cooling water for buried installations.
- Operating temperature +20°C
- Static verification for heavy traffic load of 60 tons

Certification

UK Reg4 approval

- WRAS or
- KIWA

To meet the requirements of the Water Supply (Water Fittings) Regulations 1999

Ecoflex Supra PLUS

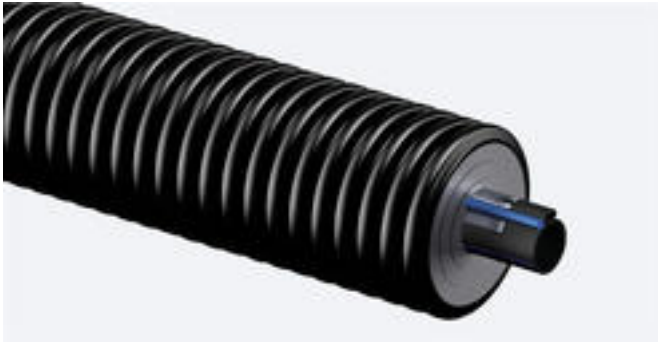

Benefits

- Coil lengths up to 150m
- No need for in-line connections
- Energy efficient frost protection
- Excellent flexibility
- Ease of installation
- Clean and hygienic
- Corrosion resistant
- Can be ordered in specified length

Uponor Ecoflex Supra PLUS is designed for cold potable water supply lines with self regulating frost protection cable with temperature being monitored by a specially designed control unit with sensor.

The system enables safe transportation of potable water, even at the lowest ambient temperatures.

Specification

- Flexible, pre-insulated, self-compensating plastic pipe system
- Medium pipe: Polyethylene PE100 RC, PN16 (SDR11) black with blue stripes
- Cable: self-regulating frost protection cable, nominal power output 10W/m at 5°C
- Electricity feed from one supply point max. 150 m
- Conduit pipe: PE tube to insert a sensor and to measure the temperature.
- Insulating material: closed-cell PE-X foam, permanently elastic, ageing-resistant
- Casing pipe: Corrugated polyethylene (HDPE)

Uponor Ecoflex Supra PLUS cable

- Cold potable water with self regulating frost protection cable
- One medium pipe PE100 RC black, SDR 11
- Max. load 16bar / 20°C
- PEX foam, HDPE casing, sensor tube
- Power output of cable 10W/m at 5°C

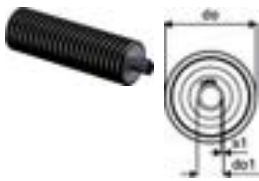

Item No.	Dimensions	R m	do mm	do1 mm	s1 mm	W kg	Pallet/ Pack	Box/M QTY	UOM	Price per m/each
1095730	25x2,3/68 1x10W/m	0,3	68	25	2,3	0,58		150	m	81,70
1095731	32x2,9/68 1x10W/m	0,4	68	32	2,9	0,67		150	m	83,03
1095734	40x3,7/140 1x10W/m	0,5	140	40	3,7	1,5		150	m	130,41
1095736	50x4,6/140 1x10W/m	0,6	140	50	4,6	1,7		150	m	134,97
1095737	63x5,8/140 1x10W/m	0,7	140	63	5,8	2,1		150	m	143,26
1095738	75x6,8/175 1x10W/m	0,9	175	75	6,8	2,9		150	m	147,95
1095739	90x8,2/200 1x10W/m	1,1	200	90	8,2	4,4		100	m	151,74
1095740	110x10,0/200 1x10W/m	1,2	200	110	10	5,3		100	m	193,90

Application

- Transport of cold potable water or pressure drainage in situations where there is a risk of freezing
- For buried installations.
- Operating temperature +20°C
- Static verification for heavy traffic load of 60 tons

Certification

UK Reg4 approval

- WRAS or
- KIWA

To meet the requirements of the Water Supply (Water Fittings) Regulations 1999

Ecoflex Supra PLUS

Uponor Ecoflex Supra PLUS con. and end set

- Connection and end set for Supra PLUS pipe
- Unit controls max.150m frost protection cable
- Controller with 10m sensor cable

Set 1

- Electrical parts for supply cable
- frost protection cable joint and cable end termination
- Two rubber end caps



Item No.	Dimensions	W kg	Pallet/ Pack	Box/M QTY	UOM	Price per m/each
1120124	25+32/68	0,8590		1	set	460,93
1120126	40+50+63/140	1,197		1	set	537,99
1120127	75/175	1,39		1	set	522,47
1120128	90+110/200	1,555		1	set	540,79

Uponor Ecoflex Supra PLUS cable set S1

Set 1

- Connection of the self regulating frost protection cable
- Supply cable
- Frost protection cable joint and cable end termination
- Frost protection cable
- Frost protection cable joint



Item No.	W kg	Pallet/ Pack	Box/M QTY	UOM	Price per m/each
1042310	0,022		1	pce	111,44

Uponor Ecoflex Supra PLUS cable set S2

Set 2

- Connection of the self regulating frost protection cable
- Frost protection cable tee
- Cable end termination



Item No.	W kg	Pallet/ Pack	Box/M QTY	UOM	Price per m/each
1042311	0,038		1	pce	273,37

Uponor Ecoflex Supra PLUS tee

- T-set for connecting the casing pipe
- ABS half sheels with insulation and reducer
- Set 2 electrical parts for frost protection cable tee and cable end termination
- Traffic load of 60 tons

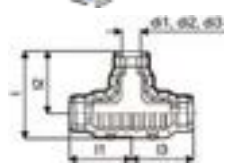

Item No.	Dimensions	di1 mm	di2 mm	di3 mm	l1 mm	l2 mm	l3 mm	l mm	W kg	Pallet/ Pack	Box/M QTY	UOM	Price per m/each
1061641	140/90/68	140	90	68	470	470	470	666	9,8	5	1	pce	851,84
1061642	200/175/140	200	175	140	562	562	562	786	13,5	3	1	pce	918,33

Compatible with:

Item No.	Dimension	Pallet/ Pack	Box/M QTY	UOM	Price per m/each
1060991	Uponor Ecoflex reducer ring 200/68	8	1	pce	50,71

Ecoflex Fitting Selector Tool

Select the correct fittings for each pipe

Thermo VIP Single



Thermo VIP Twin



Thermo Single



Thermo Twin



Thermo Mini



Thermo HP



Stage 1

Select the pipe

Carrier pipe / outer jacket - diameter	Quantity
1095714 40/140	1
1095715 50/140	1
1095716 63/140	1
1095717 75/140	1
1160605 90/175	1
1160606 110/175	1
1095720 125/200	1
1121643 140/200	1
1121644 160/250	1

Stage 2

Select the end-cap
1 required for each end

Ruber end-cap	Quantity
1018314 40+50+63/140	1
1018314 40+50+63/140	1
1018314 40+50+63/140	1
1095801 75/140	1
1018311 90+110/175	1
1018311 90+110/175	1
1067757 125/200	1
1121645 140/200	1
1121646 160/250	1

Stage 3

Select the couplers
Quantity required for each pipe end

WIPEX Coupling, 6bar	Quantity
1018330 40x1 1/4" 6bar	1
1018331 50x1 1/4" 6bar	1
1018332 63x2" 6bar	1
1018333 75x2" 6bar	1
1018334 90x3" 6bar	1
1018335 110x3" 6bar	1
1078368 125x4" 6bar	1
1121647 140x4" 6bar	1
1121648 160x5" 6bar	1

Carrier pipe / outer jacket - diameter	Ruber end-cap	Quantity	WIPEX Coupling, 6bar	Quantity
1118580 2x25/140	1018245 25+32+40/140	1	1018328 25x1" 6bar	2
1118581 2x32/140	1018245 2x25+32/140	1	1018329 32x1" 6bar	2
1160612 2x40/140	1018245 2x25+32/140	1	1018330 40x1 1/4" 6bar	2
1160613 2x50/175	1018308 25+32+50/175	1	1018331 50x1 1/4" 6bar	2
1160614 2x63/200	1018307 40+50+63/200	1	1018332 63x2" 6bar	2
1160615 2x75/250	1088979 75+90/250	1	1018333 75x2" 6bar	2

Carrier pipe / outer jacket - diameter	Ruber end-cap	Quantity	WIPEX Coupling, 6bar	Quantity
1018109 25/140	1018315 25+32/140	1	1018328 25x1" 6bar	1
1018110 32/140	1018315 25+32/140	1	1018329 32x1" 6bar	1
1018111 40/175	1018313 32+40+50/175	1	1018330 40x1 1/4" 6bar	1
1018112 50/175	1018313 32+40+50/175	1	1018331 50x1 1/4" 6bar	1
1018113 63/175	1018312 63+75/175	1	1018332 63x2" 6bar	1
1018114 75/200	1018310 75+90+110/200	1	1018333 75x2" 6bar	1
1018115 90/200	1018310 75+90+110/200	1	1018334 90x3" 6bar	1
1018116 110/200	1018310 75+90+110/200	1	1018335 110x3" 6bar	1

Carrier pipe / outer jacket - diameter	Ruber end-cap	Quantity	WIPEX Coupling, 6bar	Quantity
1018134 2x25/175	1018309 2x 25+32+40/175	1	1018328 25x1" 6bar	2
1018135 2x32/175	1018309 2x 25+32+40/175	1	1018329 32x1" 6bar	2
1018136 2x40/175	1018309 2x 25+32+40/175	1	1018330 40x1 1/4" 6bar	2
1018137 2x50/200	1018307 2x 40+50+63/200	1	1018331 50x1 1/4" 6bar	2
1018138 2x63/200	1018307 2x 40+50+63/200	1	1018332 63x2" 6bar	2

Carrier pipe / outer jacket - diameter	Ruber end-cap	Quantity	WIPEX Coupling, 6bar	Quantity
1018132 25/68	1018316 25/68	1	1018328 25x1" 6bar	1
1018133 32/68	1018316 25/68	1	1018329 32x1" 6bar	1

Carrier pipe / outer jacket - diameter	Ruber end-cap	Quantity	WIPEX Coupling, 6bar	Quantity
1093894 2x32+2x32/140	1086838 140 Thermo HP	1	1018329 32x1" 6bar	2
1093895 2x40+2x32/175	1094252 175 Thermo HP	1	1018330 40x1 1/4" 6bar	2
1137494 2x50+2x32/200	1137496 200 Thermo HP	1	1018331 50x1 1/4" 6bar	2
1137495 2x63+2x32/200	1137496 200 Thermo HP	1	1018332 63x1 1/4" 6bar	2

Pipe & Fitting Selector Tool

Select the correct fittings for each pipe

Aqua VIP Single



Stage 1	Stage 2	Stage 3
---------	---------	---------

Select the pipe

Select the end-cap
1 required for each end

Select the couplers
Quantity required for each pipe end

Carrier pipe / outer jacket - diameter	Ruber end-cap	Quantity	WIPEX Coupling	Quantity
1119047 40/140	1018314 40+50+63/140	1	1018339 40x1 1/4"	10bar 1
1119048 50/140	1018314 40+50+63/140	1	1018340 50x1 1/4"	10bar 1
1119049 63/140	1018314 40+50+63/140	1	1018341 63x2"	10bar 1
1119050 75/140	1095801 75/140	1	1018342 75x2"	10bar 1
1160620 90/175	1018311 90+110/175	1	1018343 90x3"	10bar 1
1160621 110/175	1018311 90+110/175	1	1023170 110x3"	10bar 1

Aqua VIP Twin



Carrier pipe / outer jacket - diameter	Ruber end-cap	Quantity	WIPEX Coupling	Quantity
1119053 20+25/140	1119374 20+25+32/140	1	1018336 25x1"	10bar 1
1119054 20+32/140	1119374 20+25+32/140	1	1018338 32x1"	10bar 1
1119055 25+40/175	1119374 20+25+32/140	1	1008663 20x3/4" Q&E + ring	1
1119056 32+50/175	1018308 25+32+50/175	1	1018339 40x1 1/4"	10bar 1
1132671 63+40/200	1018307 40+50+63/200	1	1018336 25x1"	10bar 1
			1018340 50x1 1/4"	10bar 1
			1018338 32x1"	10bar 1
			1018341 63x2"	10bar 1
			1018339 40x1 1/4"	10bar 1

Aqua Single



Carrier pipe / outer jacket - diameter	Ruber end-cap	Quantity	WIPEX Coupling	Quantity
1018117 25/140	1018315 25+32/140	1	1018336 25x1"	10bar 1
1018118 32/140	1018315 25+32/140	1	1018338 32x1"	10bar 1
1018119 40/175	1018313 32+40+50/175	1	1018339 40x1 1/4"	10bar 1
1018120 50/175	1018313 32+40+50/175	1	1018340 50x1 1/4"	10bar 1
1018121 63/175	1018312 63+75/175	1	1018341 63x2"	10bar 1

Aqua Twin



Carrier pipe / outer jacket - diameter	Ruber end-cap	Quantity	WIPEX Coupling	Quantity
1018139 25+25/175	1018309 2x25+32+40/175	1	1018336 25x1"	10bar 2
1018140 32+25/175	1018309 2x25+32+40/175	1	1018338 32x1"	10bar 1
1018141 40+25/175	1018309 2x25+32+40/175	1	1018336 25x1"	10bar 1
1018142 50+25/175	1018308 2x25+32+50/175	1	1018339 40x1 1/4"	10bar 1
			1018336 25x1"	10bar 1
			1018340 50x1 1/4"	10bar 1
			1018336 25x1"	10bar 1

Quattro



Carrier pipe / outer jacket - diameter	Ruber end-cap	Quantity	WIPEX Coupling	Quantity
1018147 2x25/25+25/175	1018306 175 Quattro1		1018328 25x1"	6bar 2
			1018336 25x1"	10bar 2
1018148 2x32/25+25/175	1018306 175 Quattro1		1018329 32x1"	6bar 2
			1018336 25x1"	10bar 2
1018149 2x32/32+25/175	1018306 175 Quattro1		1018329 32x1"	6bar 2
			1018338 32x1"	10bar 1
			1018336 25x1"	10bar 1

Supra / Supra +



Carrier pipe / outer jacket - diameter	Ruber end-cap	Quantity	WIPEX Coupling	Quantity
1095722 25/68	1018316 25+32/68	1	1018328 25x1"	16bar 1
1095723 32/68	1018316 25+32/68	1	1018329 32x1"	16bar 1
1095724 40/140	1018314 40+50+63/140	1	1018330 40x1 1/4"	16bar 1
1095725 50/140	1018314 40+50+63/140	1	1018331 50x1 1/4"	16bar 1
1095726 63/140	1018314 40+50+63/140	1	1018332 63x2"	16bar 1
1095727 75/175	1018312 63+75/175	1	1018333 75x2"	16bar 1
1095728 90/175	1018311 90+110/175	1	1018334 90x3"	16bar 1
1095729 110/200	1018310 75+90+110/200	1	1018335 110x3"	16bar 1

Please note: All items sold individually unless specified.

Wipex



Benefits

- Easy to install without the need for specialist tooling
- Flame-free installation
- Made of high-quality DR brass
- Corrosion resistant
- Clean and hygienic
- Reliable

Wipex jointing technology is a simple, fast and reliable connection for cross-linked polyethylene pipes used for the distribution of domestic hot and cold water, and district heating and cooling installations.

Wipex are available for pipe dimensions 25-140 mm in PN6 series, and 25-110 in PN10 series.

Specification

- Wipex fittings in corrosion-resistant brass, dezincification to BS EN ISO 6509 with stainless steel screw.
- Sizes 25-110mm, O-ring sealing between Wipex coupling and base fitting
- Sizes 125-160mm, threads must be sealed using a suitable sealing medium
- Bolt set for couplers in stainless steel with brass washer
- Pre-open sleeve design with assembled support part for the dimension 63-110mm.

Application

- Fittings for pipe systems Thermo, Aqua, Quattro, Supra, Supra PLUS and Thermo HP
- Connection of PE and PE-Xa carrier pipes to couplers
- Parallel G male thread
- Max. operating temperature 95°C

Certification

UK Reg4 approval

- WRAS or
- KIWA

To meet the requirements of the Water Supply (Water Fittings) Regulations 1999

Uponor Wipex coupling PN6

- Connection of PE-Xa or PE pipe
- 6 bar, SDR 11
- Parallel thread G" for O-ring sealing
- DZR - dezincification resistant brass

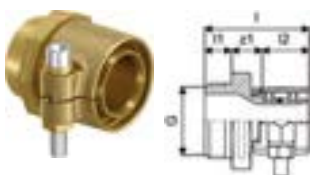

Item No.	Dimensions	G inch	l1 mm	l2 mm	l mm	s mm	z1 mm	p mm	W kg	Pallet/Pack	Box/M QTY	UOM	Price per m/each
1018328	25x2,3-G1	1	12	21	47	2,3	14	6	0,19	40	1	pce	42,87
1018329	32x2,9-G1	1	12	26	52	2,9	14	6	0,279	20	1	pce	47,15
1018330	40x3,7-G1 1/4	1 1/4	16	30	61	3,7	15	6	0,436	10	1	pce	61,91
1018331	50x4,6-G1 1/4	1 1/4	16	37	68	4,6	16	6	0,647	10	1	pce	83,18
1018332	63x5,8-G2	2	20	47	84	5,8	18	6	1,142	8	1	pce	141,70
1018333	75x6,8-G2	2	20	51	92	6,8	21	6	1,446	6	1	pce	196,64
1018334	90x8,2-G3	3	24	60	105	8,2	22	6	2,359	4	1	pce	281,41
1018335	110x10,0-G3	3	24	72	118	10	22	6	2,998	3	1	pce	354,66

Uponor Ecoflex coupling PN6

- Connection of PE-Xa or PE pipe
- 6 bar, SDR 11
- R type tapered thread, requires suitable sealing medium to be applied
- Cannot be used with Wipex fittings!
- DZR - dezincification resistant brass



Item No.	In/Out	Dimensions	l1 mm	l2 mm	l mm	R mm	s mm	z1 mm	p bar	W kg	Pallet/ Pack	Box/M QTY	UOM	Price per m/each
1078368		125x11,4-R4	43	70	137	4	11,4	24	6	4,99		1	pce	619,25
1121647	01.25	140x12,7-R4	43	70	137	4	12,7	24	6	6,5	12	1	pce	904,25
1121648	01.25	160x14,6-R5	45	70	141	5	14,6	26	6	8,2	12	1	pce	963,45

Uponor Wipex coupling PN10

- Connection of PE-Xa or PE pipe
- 10 bar, SDR 7,4
- Parallel thread G" for O-ring sealing
- DZR - dezincification resistant brass

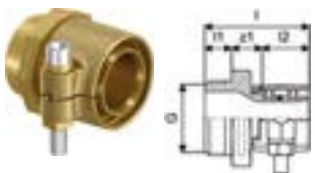

Item No.	Dimensions	G inch	l1 mm	l2 mm	l mm	s mm	z1 mm	p bar	W kg	Pallet/ Pack	Box/M QTY	UOM	Price per m/each
1018336	25x3,5-G1	1	12	21	47	3,5	14	10	0,194	40	1	pce	45,08
1018338	32x4,4-G1	1	12	26	52	4,4	14	10	0,261	20	1	pce	50,26
1018339	40x5,5-G1 1/4	1 1/4	16	30	61	5,5	16	10	0,444	10	1	pce	62,01
1018340	50x6,9-G1 1/4	1 1/4	16	37	68	6,9	16	10	0,667	10	1	pce	86,17
1018341	63x8,6-G2	2	20	46	84	8,6	18	10	1,123	8	1	pce	135,72
1018342	75x10,3-G2	2	20	51	92	10,3	21	10	1,481	6	1	pce	180,63
1018343	90x12,3-G3	3	24	59	105	12,3	22	10	2,503	4	1	pce	258,48
1023170	110x15,1-G3	3	24	72	118	15,1	22	10	3,177	3	1	pce	318,78

Uponor Wipex jointing equal PN6

- Connection of PE-Xa or PE pipe
- 6bar, SDR 11
- DR - dezincification resistant brass

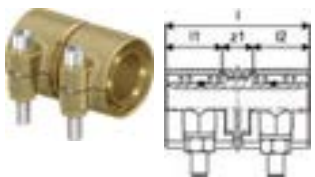

Item No.	Dimensions	l1 mm	l2 mm	l mm	s mm	z1 mm	p bar	W kg	Pallet/ Pack	Box/M QTY	UOM	Price per m/each
1042972	25x2,3-25x2,3	21	21	53,5	2,3	11,5	6	0,184	30	1	pce	61,03
1042973	32x2,9-32x2,9	25,5	25,5	62,5	2,9	11,5	6	0,338	25	1	pce	75,41
1042980	40x3,7-40x3,7	29	29	71	3,7	13	6	0,538	15	1	pce	100,09
1042984	50x4,6-50x4,6	36	36	85	4,6	13	6	0,938	10	1	pce	148,63
1042981	63x5,8-63x5,8	46	46	105	5,8	13	6	1,501	5	1	pce	240,76
1042985	75x6,8-75x6,8	50,5	50,5	123	6,8	22	6	2,331	3	1	pce	348,40
1042986	90x8,2-90x8,2	59	59	142	8,2	24	6	3,619	4	1	pce	494,23
1042987	110x10-110x10	71	71	166	10,0	24	6	4,925	2	1	pce	687,47

Uponor Ecoflex jointing equal PN6

- Connection of PE-Xa or PE pipe
- 6bar, SDR 11
- DZR - dezincification resistant brass



Item No.	In/Out	Dimensions	l1 mm	l2 mm	l mm	s mm	z1 mm	p bar	W kg	Pallet/ Pack	Box/M QTY	UOM	Price per m/each
1078365		125x11,4-125x11,4	70	70	169	11,4	29	6	7,66		1	pce	796,51
1121635	01.25	140x12,7-140x12,7	70	70	169	12,7	29	6	10,1		1	pce	954,25
1121636	01.25	160x14,6-160x14,6	70	70	169	14,6	29	6	11,8	2	1	pce	1 010,15

Uponor Wipex jointing equal PN10

- Connection of PE-Xa or PE pipe
- 10 bar, SDR 7,4
- DZR - dezincification resistant brass



Item No.	Dimensions	l1 mm	l2 mm	l mm	s mm	z1 mm	p bar	W kg	Pallet/ Pack	Box/M QTY	UOM	Price per m/each
1042970	25x3,5-25x3,5	21	21	54	3,5	12	10	0,176	40	1	pce	60,42
1042974	32x4,4-32x4,4	26	26	64	4,4	12	10	0,333	25	1	pce	77,78
1042979	40x5,5-40x5,5	30	29	72	5,5	13	10	0,539	15	1	pce	97,32
1042983	50x6,9-50x6,9	37	36	86	6,9	13	10	0,935	10	1	pce	147,53
1042982	63x8,6-63x8,6	47	46	106	8,6	13	10	1,546	4	1	pce	238,40

Uponor Wipex tee

- Parallel thread G" with sealing O-ring
- 6 bar, SDR 11 / 10 bar, SDR 7,4
- DZR - dezincification resistant brass



Item No.	Dimensions	G inch	l1 mm	l2 mm	l3 mm	p bar	W kg	Pallet/ Pack	Box/M QTY	UOM	Price per m/each
1018345	G1-G1-G1	1	35	35	35	6+10	0,333	20	1	pce	45,14
1018346	G1 1/4-G1 1/4-G1 1/4	1 1/4	42	42	42	6+10	0,503	10	1	pce	51,21
1018347	G2-G2-G2	2	55	55	55	6+10	1,025	4	1	pce	104,00
1018348	G3-G3-G3	3	75	75	75	6+10	2,499	3	1	pce	241,24

Uponor Ecoflex tee

- Parallel thread Rp - requires a suitable sealing medium
- 6 bar, SDR 11 / 10 bar, SDR 7,4
- DZR - dezincification resistant brass



Item No.	In/Out	Dimensions	Rp inch	l1 mm	l2 mm	l3 mm	p bar	W kg	Pallet/ Pack	Box/M QTY	UOM	Price per m/each
1078367		Rp4-Rp4-Rp4	4	91	91	91	6	3,44		1	pce	265,02
1121637	01.25	Rp5-Rp5-Rp5	5	119	119	119	6	7,0	12	1	pce	330,83

Uponor Wipex elbow

- Parallel thread G" with sealing O-ring
- 6 bar, SDR 11 / 10 bar, SDR 7,4
- DZR - dezincification resistant brass

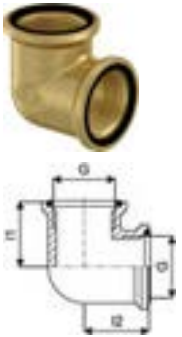

Item No.	Dimensions	G inch	l1 mm	l2 mm	p bar	W kg	Pallet/ Pack	Box/M QTY	UOM	Price per m/each
1018350	G1-G1	1	35	35	6+10	0,279	20	1	pce	38,48
1018351	G1 1/4-G1 1/4	1 1/4	42	42	6+10	0,459	15	1	pce	47,76
1018352	G2-G2	2	55	55	6+10	0,854	5	1	pce	113,38
1018353	G3-G3	3	75	75	6+10	2,184	2	1	pce	209,12

Uponor Ecoflex elbow

- Parallel thread Rp - requires a suitable sealing medium
- 6 bar, SDR 11 / 10 bar, SDR 7,4
- DZR - dezincification resistant brass

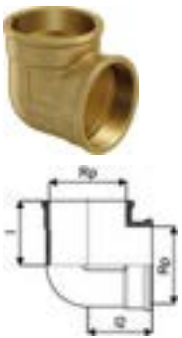

Item No.	In/Out	Dimensions	Rp inch	l1 mm	l2 mm	p bar	W kg	Pallet/ Pack	Box/M QTY	UOM	Price per m/each
1078366		Rp4-Rp4	4	92	92	6	2,65		1	pce	261,16
1121638	01.25	Rp5-Rp5	5	119	119	6	5,3	12	1	pce	339,65

Uponor Wipex sleeve

- Parallel thread G" with sealing O-ring
- 6 bar, SDR 11 / 10 bar, SDR 7,4
- DZR - dezincification resistant brass

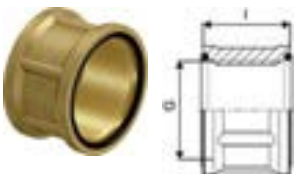

Item No.	Dimensions	G inch	l mm	p bar	W kg	Pallet/ Pack	Box/M QTY	UOM	Price per m/each
1018355	G1-G1	1	30	6+10	0,182	40	1	pce	25,97
1018356	G1 1/4-G1 1/4	1 1/4	37	6+10	0,212	25	1	pce	36,38
1018357	G2-G2	2	45	6+10	0,413	15	1	pce	63,66
1018358	G3-G3	3	55	6+10	0,739	10	1	pce	94,59

Uponor Wipex reducer male x female

- Material: brass
- Female & male thread



Item No.	Dimensions	G inch	G1 inch	l mm	z1 mm	p bar	W kg	Pallet/ Pack	Box/M QTY	UOM	Price per m/each
1018368	G1 1/4-G1	1 1/4	1	36	20	6+10	0,236	25	1	pce	29,90
1018369	G1 1/2-G1 1/4	1 1/2	1 1/4	39	21	6+10	0,246	25	1	pce	33,79
1018371	G2-G1	2	1	41	21	6+10	0,406	15	1	pce	82,64
1018372	G2-G1 1/4	2	1 1/4	45	25	6+10	0,448	15	1	pce	68,51
1018374	G3-G1	3	1	47	23	6+10	0,945	6	1	pce	141,52
1018375	G3-G1 1/4	3	1 1/4	51	27	6+10	1,04	10	1	pce	123,81
1018376	G3-G2	3	2	55	31	6+10	1,018	10	1	pce	130,80

Uponor Ecoflex reducer male x female

- Outer tapered thread R" - requires a suitable sealing medium
- Inner parallel thread G" with sealing ring for use with Wipex
- 6 bar, SDR 11 / 10bar, SDR 7,4
- DZR - dezincification resistant brass

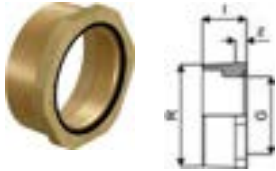

Item No.	Dimensions	G inch	l inch	R inch	z mm	p bar	W kg	Pallet/ Pack	Box/M QTY	UOM	Price per m/each
1078369	R4-G3	3	48	4	12	6	1,26	6	1	pce	212,03

Uponor Ecoflex reducer male x female

- Outer tapered thread R" - requires a suitable sealing medium
- Inner parallel thread Rp" - requires a suitable sealing medium
- 6 bar, SDR 11 / 10bar, SDR 7,4
- DZR - dezincification resistant brass



Item No.	In/Out	Dimensions	G inch	Rp inch	l mm	R inch	z mm	p bar	W kg	Pallet/ Pack	Box/M QTY	UOM	Price per m/each
1121639	01.25	R5-G4		4	57	5	13,5	6	2,036	36	1	pce	358,52

Uponor Wipex flange

- Parallel thread G" with sealing O-ring
- 6 bar, SDR 11 / 10 bar, SDR 7,4
- DZR - dezincification resistance brass



Item No.	Dimensions	G inch	do mm	k mm	no. p	p bar	W kg	Pallet/ Pack	Box/M QTY	UOM	Price per m/each
1018359	F25/4-85/G1	1	115	85	4	6+10	1,245	10	1	pce	102,83
1018360	F32/4-100/G1 1/4	1 1/4	140	100	4	6+10	1,959	5	1	pce	157,67
1018362	F50/4-125/G2	2	165	125	4	6+10	3,028	4	1	pce	297,82
1018364	F80/8-160/G3	3	200	160	8	6+10	4,183	3	1	pce	357,46

Uponor Ecoflex flange

- Parallel thread Rp" - requires suitable sealing medium
- 6 bar, SDR 11 / 10 bar, SDR 7,4
- Stainless steel

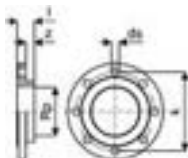

Item No.	In/Out	Dimensions	Rp inch	l mm	z mm	k mm	no. pce	p bar	W kg	Pallet/ Pack	Box/M QTY	UOM	Price per m/each
1078370		F100/8-180/Rp4	4	40	20	180	8	6	4,62		1	pce	391,70
1121640	01.25	F125/8-200/ Rp5	5	44	22	210	8	6	6,3		1	pce	583,09

Uponor Wipex swivel union

- Swivel union - double nipple
- Parallel thread G" for O-ring sealing
- 6 bar, SDR 11 / 10 bar, SDR 7,4
- DZR - dezincification resistance brass

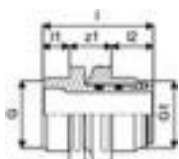

Item No.	Dimensions	G inch	G1 inch	l1 mm	l2 mm	l mm	z1 mm	p bar	W kg	Pallet/ Pack	Box/M QTY	UOM	Price per m/each
1045455	G1	1	1	12	18,8	49,8	19	6+10	0,237	20	1	pce	79,73
1045456	G1 1/4-G1	1	1 1/4	12	20,7	49,7	17	6+10	0,33	20	1	pce	86,78
1045457	G1 1/4	1 1/4	1 1/4	16	21	58,3	21,3	6+10	0,476	15	1	pce	94,21
1065442	G11/4 120mm	1 1/4	1 1/4	16	21	120	83	6+10	0,663	8	1	pce	179,26
1045458	G2-G1 1/4	2	1 1/4	16	24,8	67,8	27	6+10	1,023	10	1	pce	106,12
1045459	G2	2	2	20	24,8	73,8	29	6+10	1,104	10	1	pce	124,99
1045460	G3-G2	3	2	24	24,8	81,8	33	6+10	1,787	3	1	pce	198,87
1045461	G3	3	3	24	29,9	89,3	35,4	6+10	2,695	2	1	pce	228,98

Uponor Ecoflex weldable adapter ST PN6

- Connection of PE-Xa pipes
- 6 bar, SDR 11
- Steel adapter for welding

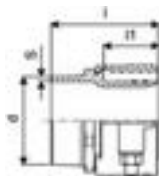

Item No.	In/Out	Dimensions	l1 mm	l mm	s mm	d mm	W kg	Pallet/ Pack	Box/M QTY	UOM	Price per m/each	
1094014		EU 32x2,9-33,7	29	63	3	33,7	0,3		1	pce	68,38	
1094015		EU 40x3,7-42,4	36	75	3,5	42,4	0,5		1	pce	83,79	
1094016		EU 50x4,6-48,3	36	84	4,15	48,3	0,7		1	pce	92,88	
1094017		EU 63x5,8-60,3	46	88	4	60,3	1		1	pce	155,43	
1094018		EU+GOST 75x6,8-76,1	53	101	5,55	76,1	1,6		1	pce	213,45	
1094019		EU+GOST 90x8,2-88,9	58	108	5	88,9	2,3		1	pce	325,03	
1094020		EU 110x10,0-114,3	70	114	5	114,3	3,5		1	pce	689,08	
1094021		EU+GOST 125x11,4-114,3	69	119	5	114,3	4,4		1	pce	742,99	
1121641	01.25	EU 140x12,7-139	70	120	6,15	139,7	5,7		1	pce	776,51	
1121642	01.25	EU 160x14,6-159	70	145	6	168,3	7,4		12	1	pce	849,09

Uponor Wipex O-Ring set PN6

- Spare part set
- Sealing rings for Wipex couplings PN 6, 25-110mm



Item No.	Dimensions	W kg	Pallet/ Pack	Box/M QTY	UOM	Price per m/each
1142340	25-110mm	0,08		1	set	11,97

Uponor Wipex O-Ring set PN10

- Spare part set
- Sealing rings for Wipex couplings PN 10, 25-110mm



Item No.	Dimensions	W kg	Pallet/ Pack	Box/M QTY	UOM	Price per m/each
1142341	25-110mm	0,08		1	set	12,78

Uponor Wipex O-Ring set

- Spare part set
- Sealing rings for Wipex Fittings G1-G3



Item No.	Dimensions	W kg	Pallet/ Pack	Box/M QTY	UOM	Price per m/each
1142342	G1-G3	0,08		1	set	21,17



Benefits

- Designed to waterproof and protect Ecoflex installations
- Practical and easy to install components
- Robust, reliable and safe
- Full range of components for all installation needs
- Prolongs the life of buried Ecoflex installation

The Uponor Ecoflex system includes all accessories for complete heating, cooling networks as well as for potable water and warm tap water supply. The accessories are designed to complement the Uponor Ecoflex pipes and fittings.

Application

- Ecoflex accessories are designed for all below ground buried installations

Specification

- All accessories are corrosion resistant.

Certification

-

Uponor Ecoflex screw set

- Screw set for tee, elbow, or straight insulation set



Item No.	Dimensions	l mm	M mm	W kg	Pallet/ Pack	Box/M QTY	UOM	Price per m/each
1060995	M6x30 (34pcs)	30	6	0,423		1	pce	35,68

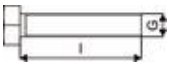

Uponor Ecoflex rubber end cap Single

- For Ecoflex single carrier pipe systems
- Protects the pipe end against moisture and dirt
- Watertight up to 0,3 bar
- Contains: EPDM rubber cap, stainless steel clamp, and sealing ring

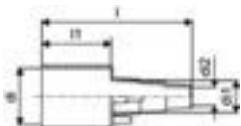

Item No.	In/Out	Dimensions	di mm	di1 mm	di2 mm	l1 mm	l mm	W kg	Pallet/ Pack	Box/M QTY	UOM	Price per m/each
1018316		25+32+40/68	68	40	25	80	174	0,15		1	pce	52,42
1018246		25+32+40/90	90	40	25	80	174	0,19		1	pce	35,46
1018315		25+28+32/140	140	32	25	90	184	0,33		1	pce	66,49
1018313		32+40+50/175	175	50	32	90	184	0,42		1	pce	85,04
1018314		40+50+63/140	140	63	40	90	184	0,34		1	pce	70,82
1095801		63+75+90/140	140	90	63	90	184	0,42		1	pce	89,93
1018312		63+75/175	175	75	63	90	184	0,44		1	pce	85,04
1018310		75+90+110/200	200	110	75	90	184	0,51		1	pce	92,56
1018311		90+110/175	175	110	90	90	184	0,46		1	pce	116,62
1067757		125/200	200	125	125	90	142	0,7		1	pce	118,77
1121645	02.25	140/200	200	140	140	90	142	0,559		1	pce	131,81
1121646	02.25	160/250	250	160	160	90	142	1,26		1	pce	136,10

Uponor Ecoflex rubber end cap Twin

- For Ecoflex twin carrier pipe systems
- Protects the pipe end against moisture and dirt
- Watertight up to 0,3 bar
- Contains: EPDM rubber cap, stainless steel clamp, and sealing ring

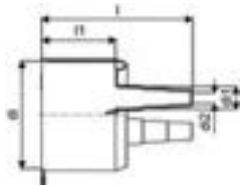

Item No.	Dimensions	di mm	di1 mm	di2 mm	l1 mm	l mm	W kg	Pallet/ Pack	Box/M QTY	UOM	Price per m/each
1119374	18-22+25-28+32/140	140	32	18	90	184	0,35		1	pce	73,94
1018245	25+32+40/140	140	40	25	90	184	0,36		1	pce	85,92
1018309	25+32+40/175	175	40	25	90	184	0,44		1	pce	82,77
1018308	25+32+50/175	175	50	25	90	184	0,45		1	pce	91,28
1018307	40+50+63/200	200	63	40	90	184	0,52		1	pce	93,47
1088979	75+90/250	250	90	75	90	194	0,8		1	pce	116,00

Uponor Ecoflex rubber end cap Quattro

- For Ecoflex four carrier pipe systems
- Protects the pipe end against moisture and dirt
- Watertight up to 0,3 bar
- Contains: EPDM rubber cap, stainless steel clamp, and sealing ring

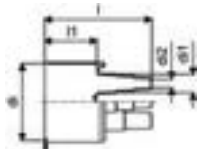

Item No.	Dimensions	di mm	di1 mm	di2 mm	l1 mm	l mm	W kg	Pallet/ Pack	Box/M QTY	UOM	Price per m/each
1086838	20+25+32/140	140	32	20	90	184	0,4		1	pce	64,71
1018306	18-22+25-28+32/175	175	32	18	90	184	0,49		1	pce	88,97
1094252	25-28+32+40/175	175	40	25	90	184	0,55		1	pce	68,99
1137496	32-50+50-63/200	200	32	63	90	184	0,710		1	pce	

Uponor Ecoflex tee insulation set

- Tee set for connecting all Ecoflex pipes
- ABS half shells with insulation and reducer
- Traffic load of 60 tons (for dimension 250 : 40 tons)

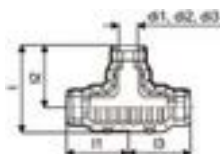

Item No.	Dimensions	di1 mm	di2 mm	di3 mm	l1 mm	l2 mm	l3 mm	l mm	W kg	Pallet/ Pack	Box/M QTY	UOM	Price per m/each
1060986	140/90/68	140	90	68	470	470	470	666	9,5	4	1	pce	668,76
1060982	200/175/140	200	175	140	562	562	562	786	13,5	4	1	pce	766,76
1121805	250/200/175/140	250	200	175/140	575	535	575	780	13,8	3	1	pce	1 413,98

Uponor Ecoflex elbow insulation set

- Elbow set for connecting Ecoflex pipes
- ABS half sheels with insulation and reducer
- Traffic load of 60 tons

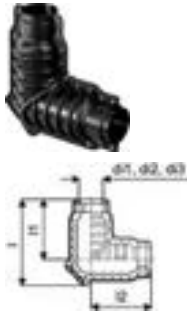

Item No.	Dimensions	di1 mm	di2 mm	di3 mm	l1 mm	l2 mm	l mm	W kg	Pallet/ Pack	Box/M QTY	UOM	Price per m/each
1060985	200/175/140	200	175	140	562,5	562,5	806	10,6	3	1	pce	660,13

Uponor Ecoflex coupling insulation set

- Straight set for connecting Ecoflex pipes
- ABS half sheels with insulation and reducer
- Traffic load of 60 tons (for dimension 250 : 40 tons)

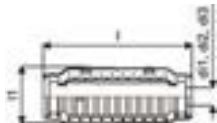

Item No.	Dimensions	di1 mm	di2 mm	di3 mm	l1 mm	l mm	W kg	Pallet/ Pack	Box/M QTY	UOM	Price per m/each
1060984	200/175/140	200	175	140	426	1125	9,6	6	1	pce	566,53
1121806	250	250	200	175/140	491	1150	10,6	4	1	pce	693,26

Uponor Ecoflex reducer ring

- Match different pipe casing dimensions in an insulation set

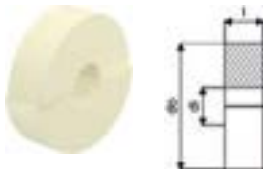

Item No.	Dimensions	di mm	l mm	do mm	W kg	Pallet/ Pack	Box/M QTY	UOM	Price per m/each
1060991	200/68	68	70	229	0,086	8	1	pce	50,71
1085107	200/160	165	70	229	0,05	12	1	pce	17,02
1121807	250/250	250	70	275	0,06		1	pce	66,66
1121808	250/200	200	70	275	0,07		1	pce	62,40
1121809	250/175	175	70	275	0,08		1	pce	62,40
1122070	250/140	140	70	275	0,07		1	pce	62,40

Uponor Ecoflex H-insulation set

- H-set for connecting the casing pipe from single and twin pipe systems
- ABS half shells with insulation and reducer spigots
- Additional rubber end caps needed for water tightness
- Traffic load with special concrete construction possible



Item No.	Dimensions	di1 mm	di2 mm	di3 mm	l1 mm	l mm	b mm	W kg	Pallet/ Pack	Box/M QTY	UOM	Price per m/each
1007355	200/175/140	200	175	140	1260	1290	428	16,4		1	pce	1 208,16

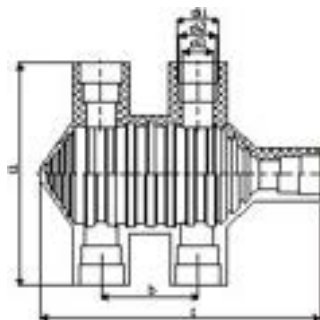

Uponor Ecoflex chamber

- Chamber for connecting the casing pipe
- PE body with insulation and reducer spigots
- T and X models available
- Traffic load of 500 kg, higher load possible with special concrete construction



Item No.	Dimensions	di mm	l1 mm	l mm	do mm	b mm	h mm	h1 mm	h2 mm	no. pce	W kg	Pallet/ Pack	Box/M QTY	UOM	Price per m/
1018326	6x140/175/200	760	1316	1652	940	300	725	420	200	6	51		3	pce	2 322,
1018327	8x140/175/200	760	1632	1652	940	300	725	420	200	8	54		3	pce	2 542,
1084576	2x250-6x140/175/200	760	1486	1652	940	300	725	420	165	8	53		1	pce	2 713,
1084577	4x250-4x140/175/200	760	1304	1652	940	300	725	420	165	8	53		1	pce	3 821,
1084578	6x250-2x140/175/200	760	1304	1486	940	300	725	420	165	8	53		1	pce	4 775,

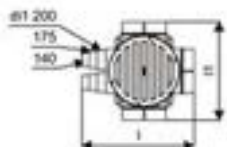
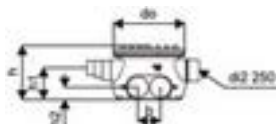

Uponor Ecoflex sealing tape for chamber

- Filling radial gaps in chamber or other outlets
- Only use in combination with shrink sleeves



Item No.	Dimensions	b mm	W kg	Pallet/ Pack	Box/M QTY	UOM	Price per m/each
1018382	50mm x 10m	50	1,476		10	pce	131,96

Uponor Ecoflex shrink sleeve

- Sealing pipe casing with chamber or other casing outlets

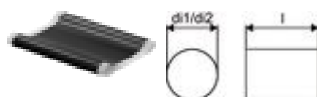

Item No.	Dimensions	di1 mm	di2 mm	l mm	W kg	Pallet/ Pack	Box/M QTY	UOM	Price per m/each
1018379	140	220	135	300	0,5		1	pce	61,34
1018380	175/200	270	160	300	0,55		1	pce	62,48
1084575	250	335	222	300	0,8	15	1	pce	90,48

Uponor Ecoflex house connection elbow Single

- For Ecoflex single carrier pipe systems
- Pre-insulated PE-Xa pipe elbow
- One medium pipe PE-Xa, SDR 11
- Max. Load 6bar / 80°C
- PUR foam, PE casing

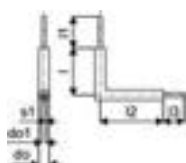

Item No.	Dimensions	l1 mm	l2 mm	l3 mm	l mm	do mm	do1 mm	s1 mm	W kg	Pallet/ Pack	Box/M QTY	UOM	Price per m/each
1118765	50x4,6/140	200	1200	200	900	140	50	4,6	3,78		1	pce	307,71
1118766	63x5,8/140	200	1200	200	900	140	63	5,8	4,78		1	pce	354,48
1118767	75x6,8/140	200	1200	200	900	140	75	6,8	5,88		1	pce	532,59
1118768	90x8,2/200	200	1200	200	900	200	90	8,2	10,5		1	pce	960,30
1118769	110x10/200	200	1200	200	900	200	110	10	13,1		1	pce	1 064,13
1118770	125x11,4/200	200	1200	200	900	200	125	11,4	18,13		1	pce	1 075,10

Uponor Ecoflex house connection elbow Twin

- For Ecoflex twin carrier pipe systems
- Pre-insulated PE-Xa pipe elbow
- Two medium pipes PE-Xa
- Max. load 6 bar / 80°C
- PUR foam, PE casing

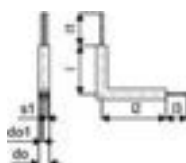

Item No.	Dimensions	l1 mm	l2 mm	l3 mm	l mm	do mm	do1 mm	s1 mm	W kg	Pallet/ Pack	Box/M QTY	UOM	Price per m/each
1118771	2x25x2,3/140	200	1200	200	900	140	25	2,3	5,0		1	pce	319,51
1118772	2x32x2,9/140	200	1200	200	900	140	32	2,9	5,25		1	pce	323,66
1118773	2x40x3,7/160	200	1200	200	900	160	40	3,7	5,5		1	pce	362,03
1118774	2x50x4,6/200	200	1200	200	900	200	50	4,6	6,15		1	pce	444,34
1118775	2x63x5,8/200	200	1200	200	900	200	63	5,8	11,73		1	pce	531,06
1118776	2x75x6,8/250	200	1200	200	900	250	75	6,8	16,25		1	pce	829,56

Uponor Ecoflex wall seal PWP

- For concrete core hole or fibre cement pipe
- Part to seal the casing pipe
- Applicable for PWP (pressurized water)
- Watertight up to 0,3bar



Item No.	Dimensions	di mm	l mm	do mm	W kg	Pallet/ Pack	Box/M QTY	UOM	Price per m/each
1007358	68	68	110	125	1,124		1	pce	350,48
1007360	140	145	110	200	2,236		1	pce	582,80
1007361	175	175	110	250	3,3		1	pce	749,34
1007362	200	200	110	300	5,238		1	pce	934,41

Uponor Ecoflex additional insert

- For concrete core hole or fibre cement pipe
- Part to eliminate radial stress of the casing pipe
- Used with Uponor wall seal PWP



Item No.	Dimensions	di mm	l mm	do mm	W kg	Pallet/ Pack	Box/M QTY	UOM	Price per m/each
1007365	140	140	65	200	1,507		1	pce	336,92
1007366	175	175	65	250	2,25		1	pce	426,74
1007367	200	200	65	300	3,44		1	pce	601,89

Uponor Ecoflex fibre cement pipe PWP

- Enbed in a brick wall or concrete wall
- Alternative to water-proof concrete core hole
- Applicable for Uponor wall seal PWP (pressurized water)
- "Dimension" - refers to pipe jacket diameter



Item No.	Dimensions	di mm	l mm	do mm	W kg	Pallet/ Pack	Box/M QTY	UOM	Price per m/each
1007370	140	200	400	250	13,04	24	1	pce	231,18
1007371	175	250	400	300	16,254	24	1	pce	301,80
1007372	200	300	400	350	19,889	12	1	pce	368,80
1091431	250	350	400	400	25,35		1	pce	205,56

Uponor Ecoflex wall sleeve set NPW

- For cast concrete and brick walls
- Applicable for NWP - no water pressurized area
- Contains PE pipe and shrink sleeve



Item No.	Dimensions	di mm	l mm	do mm	W kg	Pallet/ Pack	Box/M QTY	UOM	Price per m/each
1018267	68+90	95	550	110	1		1	pce	77,15
1018269	140	175	550	200	1,615		1	pce	84,52
1018268	175+200	218	550	250	1,665		1	pce	104,99
1083871	250	275	550	315	2,9	16	1	pce	136,48

Uponor Ecoflex conduit angle

- Conduit for Ecoflex pipe to enter through the floor of a building



Item No.	Dimensions	di mm	do mm	s mm	W kg	Pallet/ Pack	Box/M QTY	UOM	Price per m/each
1030269	175/140	237,8	250	6,1	12		9	pce	432,16
1030270	200	299,6	315	7,7	17		9	pce	690,29

Uponor Ecoflex pipe bend support

- Guiding Ecoflex pipes 90° in base floor penetration
- Metal support braces can be linked together



Item No.	Dimensions	W kg	Pallet/ Pack	Box/M QTY	UOM	Price per m/each
1034302	175 r=800mm	8		1	pce	248,64
1034303	200 r=1000mm	8		1	pce	248,64

Uponor Ecoflex repair sleeve

- Shrink sleeve to seal damages in pipe outer casing

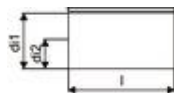

Item No.	Dimensions	di1 mm	di2 mm	l mm	W kg	Pallet/ Pack	Box/M QTY	UOM	Price per m/each
1036014	140+175+200-700mm	226	98	700	1,033		1	pce	412,66

Uponor Ecoflex shrink tape

- Shrinkable tape use for sealing damaged outer pipe casings

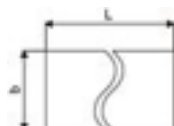

Item No.	Dimensions	W kg	Pallet/ Pack	Box/M QTY	UOM	Price per m/each
1093120	160mm x 10m	2,4	30	1	pce	310,57

Uponor Ecoflex trench warning tape, red

- For marking the position of buried Ecoflex pipes
- Tape marking with required application symbols

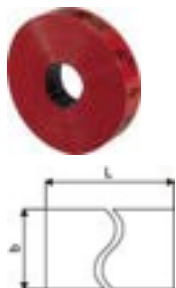

Item No.	Dimensions	b mm	W kg	Pallet/ Pack	Box/M QTY	UOM	Price per m/each
1018385	40mm x 250m	40	1,2		1	pce	57,93









Uponor Ecoflex sealing paste

- Sealant to seal and waterproof the insulation set.



Item No.	Dimensions	W kg	Pallet/ Pack	Box/M QTY	UOM	Price per m/each
1060996	290ml	0,491		1	pce	33,72

Compatible with:

Item No.	Dimension	Pallet/ Pack	Box/M QTY	UOM	Price per m/each
 1089677	Uponor Multi pipe cutting tool 32-40	12	1	pce	46,88
 1089779	Uponor Multi cutting tool blade 32-40	50	1	pce	18,63
 1089675	Uponor Multi pipe cutting tool 25-63	12	1	pce	57,94
 1089777	Uponor Multi cutting tool blade 25-63	50	1	pce	6,59
 1089676	Uponor Multi pipe cutting tool 50-125	8	1	pce	108,26
 1089778	Uponor Multi cutting tool blade 50-125	50	1	pce	9,32
 1060167	Uponor MLC deburring tool universal	50	1	pce	21,61
 1046407	Uponor Wipex sleeve plier 1 - 1 1/2	25	1	pce	30,96

Combi Port Gen



Combi Port Gen is a dedicated range of accessories designed to complement Uponor Combi Port and Aqua Port heat interface units. The line enables flexible configuration, extension, and safe operation of decentralized heating and domestic hot water systems by providing compatible hydraulic, control, and connection components for professional installations.

Specification

- Accessory components for hydraulic, safety, and control functions
- Designed for direct compatibility with Combi Port heat interface units and Central Port units
- Includes valves, connections, extensions, and functional add-ons
- Suitable for heating and domestic hot water applications
- Engineered for reliable integration into Uponor system solutions

Benefits

- Purpose-built accessories for seamless Combi Port and Central Port integration
- Enables flexible system design and future extensions
- Supports safe and efficient hydraulic performance
- Simplifies installation and commissioning
- Designed to meet professional installation requirements

Application

- Accessories for Uponor Combi Port heat interface units and Central Ports
- Decentralized heating and domestic hot water systems
- Centralized domestic hot water systems
- Residential and multi-dwelling buildings
- New installations and system extensions
- Commissioning, balancing, and system optimization

Combi Port Gen

Uponor Combi Port Gen Ball valves

- Non-sanitary ball valve sets
- Dimensioning codes:
- x_ – quantity of ball valves included in set (_ pcs)
- DN20 – ball valve size
- MT – male thread connection
- FT – female thread connection

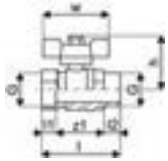

Item No.	Dimensions	G	G1	l1	l2	l	z	h	w	z1	Pallet/ Pack	Box/M QTY	UOM	Price per m/
		inch	inch	mm	mm	mm	mm	mm	mm	mm				
1103009	x2, DN20, MT/FT										180	1	pce	28,26
1121010	x4, DN20, MT/FT										36	1	set	42,22
1103010	x6, DN20, MT/FT										100	1	pce	61,98

Uponor Combi Port Gen heat exchanger GKS 228H-26 CU

- Copper brazed heat exchanger GKS 228H-26 CU



Item No.	L	W	H	W	Pallet/ Pack	Box/M QTY	UOM	Price per m/each
	mm	mm	mm	kg				
1116247	328	90	71	2,77		1	pce	312,22

Uponor Combi Port Gen heat exchanger GKE 228H-40 CU

- Copper brazed heat exchanger GKE 228H-40 CU



Item No.	L	W	H	W	Pallet/ Pack	Box/M QTY	UOM	Price per m/each
	mm	mm	mm	kg				
1116193	330	90	73	3,16		1	pce	455,42

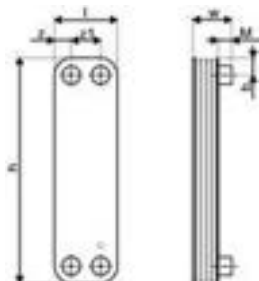

Combi Port Gen

Uponor Combi Port Gen diff press control DN15, 100-400mbar

- Differential pressure control DN15, 100-400mbar



Item No.	L mm	W mm	H mm	W kg	Pallet/ Pack	Box/M QTY	UOM	Price per m/each
1116229	95	65	65	1,2		1	pce	225,00

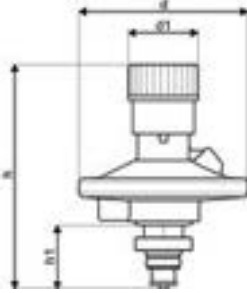

Uponor Combi Port Gen heat exchanger GKE 228H-24 CU

- Copper brazed heat exchanger GKE 228H-24 CU



Item No.	L mm	W mm	H mm	W kg	Pallet/ Pack	Box/M QTY	UOM	Price per m/each
1116191	330	90	57	2,5		1	pce	292,14

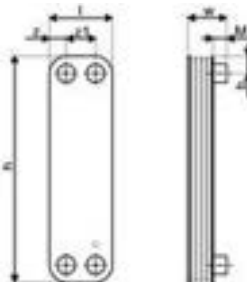

Uponor Combi Port Gen thermostat TWB 15-50degC

- Thermostatic temperature limiter 15-50 with submersible sensor



Item No.	L mm	W mm	H mm	W kg	Pallet/ Pack	Box/M QTY	UOM	Price per m/each
1116226	60	45	45	0,23		1	pce	207,76

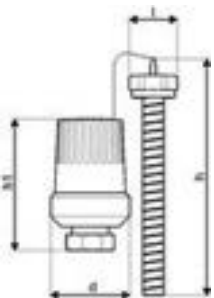

Combi Port Gen

Uponor Combi Port Gen expansion vessel 8l round

- Expansion vessel 8l - round
- G3/8"



Item No.	L mm	W mm	H mm	W kg	Pallet/ Pack	Box/M QTY	UOM	Price per m/each
1116237	420	420	75	4,5		1	pce	93,44

Uponor Combi Port Gen diff press control DN15, 50-1000l/h

- Differential pressure control DN15, 50-1000l/h



Item No.	L mm	W mm	H mm	W kg	Pallet/ Pack	Box/M QTY	UOM	Price per m/each
1116231	95	65	65	0,5		1	pce	163,35

Uponor Combi Port Gen strainer G3/4

- Valve with right angled strainer insert
- G3/4"



Item No.	L mm	W mm	H mm	W kg	Pallet/ Pack	Box/M QTY	UOM	Price per m/each
1116256	60	28	42	0,156		1	pce	30,36

Uponor Combi Port Gen return temp limit RTB 0-40degC, Kvs = 1,8

- For Combi Ports



Item No.	L mm	W mm	H mm	W kg	Pallet/ Pack	Box/M QTY	UOM	Price per m/each
1116223	60	45	45	0,33		1	pce	96,93

Uponor Combi Port Gen seal set 1" 21x30x1,8mm

- Seal set 1" 21x30x1,8mm

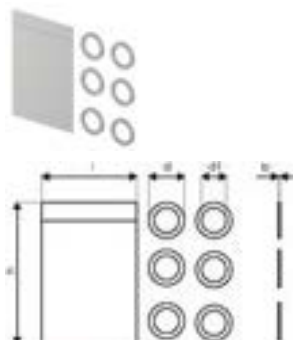

Item No.	L mm	W mm	H mm	W kg	Pallet/ Pack	Box/M QTY	UOM	Price per m/each
1116220	120	80	35	0,046		1	set	21,22

Combi Port Gen

Uponor Combi Port Gen strainer HM pocket mesh 0,5mm

- Strainer 3/4" MT with heat meter sensor connection M10X1



Item No.	L mm	W mm	H mm	W kg	Pallet/ Pack	Box/M QTY	UOM	Price per m/each
1116198	65	35	40	0,26		1	pce	49,15

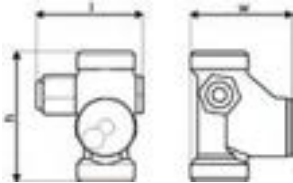

Uponor Combi Port Gen PM controller DW 3-way

- 3 way PM controller for domestic hot water and heating



Item No.	L mm	W mm	H mm	W kg	Pallet/ Pack	Box/M QTY	UOM	Price per m/each
1116228	250	80	100	1,4		1	pce	387,09

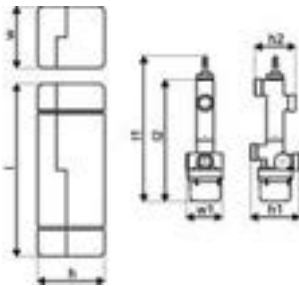

Uponor Combi Port Gen heat exchanger DW GVH 228H-40 VA

- Stainless Steel brazed heat exchanger DW GVH 228H-40 VA



Item No.	L mm	W mm	H mm	W kg	Pallet/ Pack	Box/M QTY	UOM	Price per m/each
1116194	330	90	73	3,7		1	pce	707,56

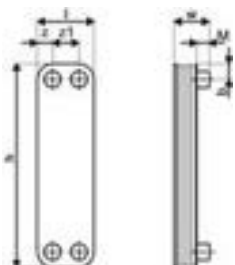

Combi Port Gen

Uponor Combi Port Gen heat exchanger GVH 228H-X-40 VA

- Stainless Steel brazed heat exchanger GVH 228H-X-40 VA

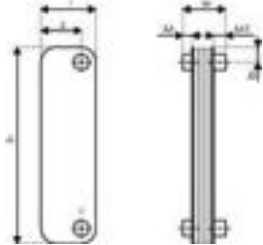

Item No.	L mm	W mm	H mm	W kg	Pallet/ Pack	Box/M QTY	UOM	Price per m/each
1116250	328	90	87.2	3,82		1	pce	953,47

Uponor Combi Port Gen valve insert TM KVS 2,8

- For Combi Ports



Item No.	L mm	W mm	H mm	W kg	Pallet/ Pack	Box/M QTY	UOM	Price per m/each
1116215	40	35	35	0,055		1	pce	54,71

Uponor Combi Port Gen actuator 230V NC 2-point VA10 gray

- Actuator 230V NC 2-point VA10 grey

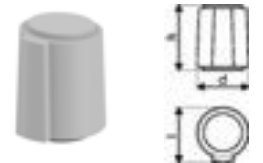

Item No.	L mm	W mm	H mm	W kg	Pallet/ Pack	Box/M QTY	UOM	Price per m/each
1116203	80	48	48	0,2		1	pce	37,54

Uponor Combi Port Gen strainer G1 incl mesh

- Strainer G1" including mesh
- For pump module FPI and EPI



Item No.	L mm	W mm	H mm	W kg	Pallet/ Pack	Box/M QTY	UOM	Price per m/each
1116196	35	30	30	0,2		1	pce	45,14

Uponor Combi Port Gen pump UPM3 7m

- Grundfos pump UPM3 Auto L15-70

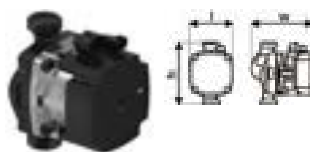

Item No.	L mm	W mm	H mm	W kg	Pallet/ Pack	Box/M QTY	UOM	Price per m/each
1116254	130	130	90	1,8		1	pce	401,19

Combi Port Gen

Uponor Combi Port Gen heat exchanger GVH 228H-24 VA

- Stainless Steel brazed heat exchanger GVH 228H-24 VA



Item No.	L mm	W mm	H mm	W kg	Pallet/ Pack	Box/M QTY	UOM	Price per m/each
1116249	328	90	68	2,63		1	pce	517,84

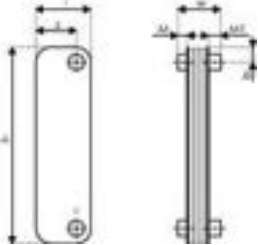

Uponor Combi Port Gen ball valve heating blue G3/4

- Ball valve heating blue G3/4



Item No.	L mm	W mm	H mm	W kg	Pallet/ Pack	Box/M QTY	UOM	Price per m/each
1116243	63	35	57	0,25		1	pce	25,64

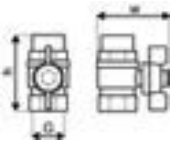

Uponor Combi Port Gen heat exchanger DW GVH 228H-24 VA

- Heat exchanger DW GVH 228H-24 VA



Item No.	L mm	W mm	H mm	W kg	Pallet/ Pack	Box/M QTY	UOM	Price per m/each
1116192	330	90	57	2,6		1	pce	614,45

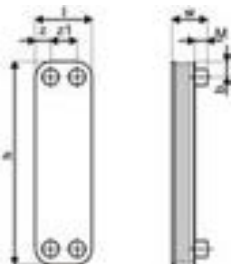

Combi Port Gen

Uponor Combi Port Gen expansion vessel 8l

- Expansion vessel 8l

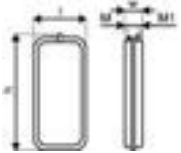

Item No.	L mm	W mm	H mm	W kg	Pallet/ Pack	Box/M QTY	UOM	Price per m/each
1116236	238	516	80	5,25		1	pce	92,66

Uponor Combi Port Gen ball valve heating red G3/4

- Ball valve heating red G3/4

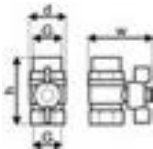

Item No.	L mm	W mm	H mm	W kg	Pallet/ Pack	Box/M QTY	UOM	Price per m/each
1116242	63	35	57	0,25		1	pce	25,64

Uponor Combi Port Gen vent valve G 1/8

- Vent valve G 1/8

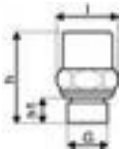

Item No.	L mm	W mm	H mm	W kg	Pallet/ Pack	Box/M QTY	UOM	Price per m/each
1116213	40	35	35	0,02		1	pce	15,33

Uponor Combi Port Gen diff press control DN15, 50-300mbar

- Differential pressure control DN15, 50-300mbar

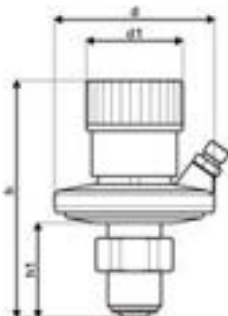

Item No.	L mm	W mm	H mm	W kg	Pallet/ Pack	Box/M QTY	UOM	Price per m/each
1116230	95	65	65	0,7		1	pce	209,75

Combi Port Gen

Uponor Combi Port Gen pump UPM3 5m

- Grundfos pump UPM3, Auto L 15-50, 5m

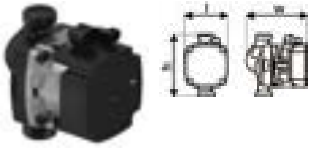

Item No.	L mm	W mm	H mm	W kg	Pallet/ Pack	Box/M QTY	UOM	Price per m/each
1116253	130	130	90	1,8		1	pce	286,35

Uponor Combi Port Gen heat exchanger GBS 220H-16 CU

- Copper soldered Heat exchanger GBS 220H-16 CU

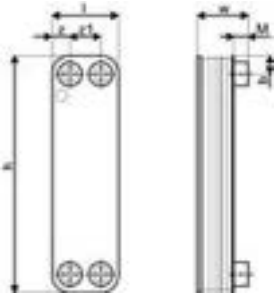

Item No.	L mm	W mm	H mm	W kg	Pallet/ Pack	Box/M QTY	UOM	Price per m/each
1116238	328	90	56	2,58		1	pce	364,39

Uponor Combi Port Gen thermostat valve TTV 35-60°C

- Thermostat valve TTV 35-60°C

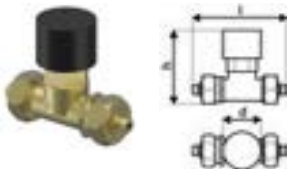

Item No.	L mm	W mm	H mm	W kg	Pallet/ Pack	Box/M QTY	UOM	Price per m/each
1116199	60	45	45	0,43		1	pce	100,20

Uponor Combi Port Gen drain valve G1/4

- Drain valve SFE G1/4



Item No.	L mm	W mm	H mm	W kg	Pallet/ Pack	Box/M QTY	UOM	Price per m/each
1116200	35	35	35	0,075		1	pce	24,31

Combi Port Gen

Uponor Combi Port Gen const temp limiter 20-50degC UFH

- Const temp limiter 20-50degC UFH

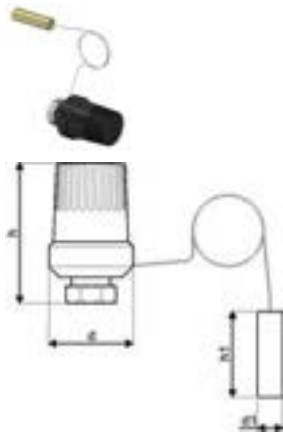

Item No.	L mm	W mm	H mm	W kg	Pallet/ Pack	Box/M QTY	UOM	Price per m/each
1116232	60	45	45	0,27		1	pce	150,07

Uponor Combi Port Gen heat exchanger G3/4 GBS 220H-16 CU

- Copper soldered heat exchanger G3/4 GBS 220H-16 CU



Item No.	L mm	W mm	H mm	W kg	Pallet/ Pack	Box/M QTY	UOM	Price per m/each
1116239	328	90	56	2,6		1	pce	372,65

Uponor Combi Port Gen strainer insert mesh 0,5mm

- Strainer insert mesh 0,5mm

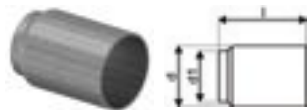

Item No.	L mm	W mm	H mm	W kg	Pallet/ Pack	Box/M QTY	UOM	Price per m/each
1116197	35	30	30	0,001		1	pce	22,46

Uponor Combi Port Gen vent valve G 1/2

- Vent valve G 1/2



Item No.	L mm	W mm	H mm	W kg	Pallet/ Pack	Box/M QTY	UOM	Price per m/each
1116212	40	35	35	0,02		1	pce	27,07

Combi Port Gen

Uponor Combi Port Gen thermostat TWB 35-70degC

- Thermostat TWB 35-70degC



Item No.	L mm	W mm	H mm	W kg	Pallet/ Pack	Box/M QTY	UOM	Price per m/each
1116225	60	45	45	0,23		1	pce	223,11

Uponor Combi Port Gen heat exchanger GKS 228H-42 CU

- Copper soldered heat exchanger GKS 228H-42 CU



Item No.	L mm	W mm	H mm	W kg	Pallet/ Pack	Box/M QTY	UOM	Price per m/each
1116248	328	90	87.2	4,4		1	pce	416,28

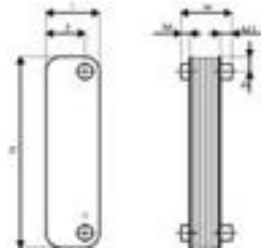

Compatible with:

Wastewater Systems

Air admittance valves to ventilate soil and waste pipes shower inlets and drains.



Silenta Premium



Silenta Premium is a sound-insulated waste-water pipe system providing a complete solution with the highest level of sound protection, combined with high durability, impact resistance, and easy installation.

Made of specially formulated and reinforced PP material, the three-layer drainage pipe system is designed for gravity-fed domestic drainage and complies with BS EN 1451.

Available in diameters DN 58 to DN 200, Silenta Premium offers excellent chemical and temperature resistance, and comes with a full range of fittings, ensuring a long-lasting, safe, and comfortable drainage solution.

Specification

- Manufactured with the latest generation of multilayer (three different layers) polypropylene technology
- System according to the requirements of BS EN 1451
- Application are B to BS EN 1451
- 12 db(A) at 4l/s - tested to BS EN 14366
- Fire class D - s2, d2 to BS EN 13501-1
- Pipe diameters from 58 mm to 200 mm
- Wide range of fittings to give complete design freedom
- For use with GF Silent Clamp range

Benefits

Silenta Premium provides the highest levels of sound insulation, removing unwanted noise from the wastewater system and enhancing user comfort in the property.

- Suitable for hot and cold water as well as acidic liquids
- A lightweight, reliable alternative to cast iron pipes
- Free from halogens and does not release halogenic gases in event of fire
- 100% recyclable and environmentally friendly
- Corrosion-free and highly durable
- Light grey Colour makes internal inspection easy

Application

Applications:

Silenta Premium is suitable for various wastewater types and areas of use, including:

- High end residential, multi-family residential, hotels, healthcare, restaurants, etc
- Sustainable/green buildings
- Industrial facilities (short- and long-term use)
- Domestic sewage and rainwater
- Wastewater from kitchens, bathrooms, laundry rooms, toilets, and similar spaces

Commercial/Industrial Wastewater:

- For untreated wastewater containing harmful substances
- Guidance relating to chemical resistance of Polypropylene can be sought from ISO/TR 10358
- For full system chemical compatibility please contact GF
- Required details for assessment:
 - Substance composition
 - Concentration and pH values
 - Quantities and flow rates
 - Wastewater temperature

Certification

- BBA (Pending)

Silenta Premium

GF Silenta premium pipe with single socket

- Light Grey, three-layer, PP-material with inorganic filler
- According to BS EN 1451

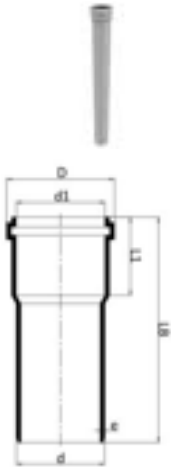

Item No.	Item no. GF	Dimensions	d/d1 mm	d1 mm	d mm	D mm	e mm	L mm	LB mm	Length mm	remarks	Pallet/ Pack	Box/M QTY	UOM	Price per m/
1160785	4401005801021	58x150mm		58	58	73.2	4.1	150	210			4	1	pce	POA
1160786	4401005801121	58x250mm		58	58	73.2	4.1	250	310			4	1	pce	POA
1160787	4401007805021	78x150mm		78	78	93.9	4.6	150	215			4	1	pce	POA
1160788	4401007805121	78x250mm		78	78	93.9	4.6	250	315			4	1	pce	POA
1160789	4401009005021	90x150mm		90	90	107.0	4.7	150	220			4	1	pce	POA
1160790	4401009005121	90x250mm		90	90	107.0	4.7	250	320			4	1	pce	POA
1160791	4401011005021	110x150mm		110	110	128.9	5.3	150	225			3	1	pce	POA
1160792	4401011005121	110x250mm		110	110	128.9	5.3	250	325			3	1	pce	POA
1146216	4401009005521	90x3000mm	90			107.0	4.7	3070	3000	**		60	1	pce	POA
1146184	4401005801221	58x500mm	58			73.2	4.1	560	500			30	1	pce	POA
1146185	4401005801321	58x1000mm	58			73.2	4.1	1060	1000	**		114	1	pce	POA
1146186	4401005801421	58x2000mm	58			73.2	4.1	2060	2000	**		114	1	pce	POA
1146187	4401005801521	58x3000mm	58			73.2	4.1	3060	3000	**		114	1	pce	POA
1146199	4401007805221	78x500mm	78			93.9	4.6	565	500			16	1	pce	POA
1146200	4401007805321	78x1000mm	78			93.9	4.6	1065	1000	**		70	1	pce	POA
1146201	4401007805421	78x2000mm	78			93.9	4.6	2065	2000	**		70	1	pce	POA
1146202	4401007805521	78x3000mm	78			93.9	4.6	3065	3000	**		70	1	pce	POA
1146213	4401009005221	90x500mm	90			107.0	4.7	520	500			12	1	pce	POA
1146214	4401009005321	90x1000mm	90			107.0	4.7	1070	1000	**		60	1	pce	POA
1146215	4401009005421	90x2000mm	90			107.0	4.7	2070	2000	**		60	1	pce	POA
1146222	4401011005221	110x500mm	110			128.9	5.3	575	500			8	1	pce	POA
1146223	4401011005321	110x1000mm	110			128.9	5.3	1075	1000	**		40	1	pce	POA
1146224	4401011005421	110x2000mm	110			128.9	5.3	2075	2000	**		40	1	pce	POA
1146225	4401011005521	110x3000mm	110			128.9	5.3	3075	3000	**		40	1	pce	POA
1146238	4401013506021	135x150mm	135			154.6	5.3	225	150			12	1	pce	POA
1146239	4401013506121	135x250mm	135			154.6	5.3	325	250			8	1	pce	POA
1146240	4401013506221	135x500mm	135			154.6	5.3	575	500			5	1	pce	POA
1146241	4401013506321	135x1000mm	135			154.6	5.3	1075	1000	**		24	1	pce	POA
1146242	4401013506421	135x2000mm	135			154.6	5.3	2075	2000	**		24	1	pce	POA
1146243	4401013506521	135x3000mm	135			154.6	5.3	3075	3000	**		24	1	pce	POA
1146251	4401016007021	160x150mm	160			183.2	5.3	235	150			10	1	pce	POA
1146252	4401016007121	160x250mm	160			183.2	5.3	335	250			6	1	pce	POA
1146253	4401016007221	160x500mm	160			183.2	5.3	585	500			4	1	pce	POA
1146254	4401016007321	160x1000mm	160			183.2	5.3	1085	1000	**		21	1	pce	POA
1146255	4401016007421	160x2000mm	160			183.2	5.3	2085	2000	**		21	1	pce	POA
1146256	4401016007521	160x3000mm	160			183.2	5.3	3085	3000	**		21	1	pce	POA
1146263	4401020008121	200x1000mm	200			228.0	6.2	1100	1000	**		15	1	pce	POA
1146264	4401020008221	200x2000mm	200			228.0	6.2	2100	2000	**		15	1	pce	POA
1146265	4401020008421	200x3000mm	200			228.0	6.2	3100	3000	**		15	1	pce	POA

Silenta Premium

GF Silenta premium pipe with double socket

- Light Grey, three-layer, PP-material with inorganic filler
- According to BS EN 1451



Item No.	Item no. GF	Dimensions	L mm	W mm	H mm	W kg	Pallet/ Pack	Box/M QTY	UOM	Price per m/each
1146188	4401005802121	58x1000mm	80	1120	80	1,292		1	pce	POA
1146203	4401007806121	78x1000mm	100	1130	100	1,978		1	pce	POA
1146226	4401011006121	110x1000mm	140	1150	140	3,349		1	pce	POA

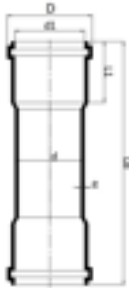

GF Silenta premium pipe without socket

- Light Grey, three-layer, PP-material with inorganic filler
- According to BS EN 1451



Item No.	Item no. GF	Dimensions	d mm	e mm	LB mm	Length mm	remarks	Pallet/ Pack	Box/M QTY	UOM	Price per m/each
1146189	4401005810021	58x3000mm	58	4.1	3000	3000	**	114	1	pce	POA
1146204	4401007810021	78x3000mm	78	4.6	3000	3000	**	70	1	pce	POA
1146217	4401009010021	90x3000mm	90	4.7	3000	3000	**	60	1	pce	POA
1146227	4401011010021	110x3000mm	110	5.3	3000	3000	**	40	1	pce	POA
1146244	4401013510021	135x3000mm	135	5.3	3000	3000	**	24	1	pce	POA
1146257	4401016010021	160x3000mm	160	5.3	3000	3000	**	21	1	pce	POA
1146266	4401020010021	200x3000mm	200	6.2	3000	3000	**	15	1	pce	POA

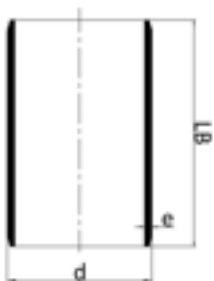

Silenta Premium

GF Silenta premium elbow 15deg

- Light Grey, PP-material with inorganic filler
- According to BS EN 1451



Item No.	Item no. GF	Dimensions	d mm	e mm	L1 mm	LB mm	Pallet/ Pack	Box/M QTY	UOM	Price per m/each
1146274	4501105830021	58mm	58	4.1	53	130	4	1	pce	POA
1146284	4501107830021	78mm	78	4.6	55	140	4	1	pce	POA
1146293	4501109030021	90mm	90	4.7	59	142	3	1	pce	POA
1146304	4501111030021	110mm	110	5.3	59	162	4	1	pce	POA
1146312	4501113530021	135mm	135	5.3	63	184	12	1	pce	POA
1146318	4501116030021	160mm	160	5.3	77	225	8	1	pce	POA

GF Silenta premium elbow 30deg

- Light Grey, PP-material with inorganic filler
- According to BS EN 1451

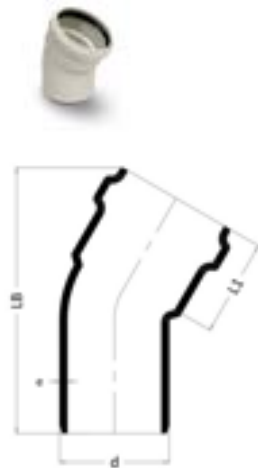

Item No.	Item no. GF	Dimensions	d mm	e mm	L1 mm	LB mm	Pallet/ Pack	Box/M QTY	UOM	Price per m/each
1146275	4501105830121	58mm	58	4.1	53	138	4	1	pce	POA
1146285	4501107830121	78mm	78	4.6	55	153	4	1	pce	POA
1146294	4501109030121	90mm	90	4.7	59	158	3	1	pce	POA
1146305	4501111030121	110mm	110	5.3	60	179	4	1	pce	POA
1146313	4501113530121	135mm	135	5.3	63	208	12	1	pce	POA
1146319	4501116030121	160mm	160	5.3	79	243	8	1	pce	POA

Silenta Premium

GF Silenta premium elbow 45deg

- Light Grey, PP-material with inorganic filler
- According to BS EN 1451



Item No.	Item no. GF	Dimensions	d mm	e mm	L1 mm	LB mm	Pallet/ Pack	Box/M QTY	UOM	Price per m/each
1146276	4501105830221	58mm	58	4.1	53	141	4	1	pce	POA
1146286	4501107830221	78mm	78	4.6	55	155	4	1	pce	POA
1146295	4501109030221	90mm	90	4.7	59	158	4	1	pce	POA
1146306	4501111030221	110mm	110	5.3	60	194	4	1	pce	POA
1146314	4501113530221	135mm	135	5.3	63	222	12	1	pce	POA
1146320	4501116030221	160mm	160	5.3	79	268	8	1	pce	POA
1146324	4501120030021	200mm	200	6.2	87	322	4	1	pce	POA

GF Silenta premium elbow long 45deg

- Light Grey, PP-material with inorganic filler
- According to BS EN 1451

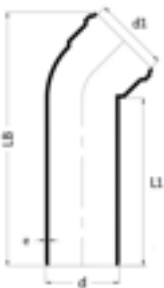

Item No.	Item no. GF	Dimensions	d/d1 mm	e mm	L1 mm	LB mm	Pallet/ Pack	Box/M QTY	UOM	Price per m/each
1146309	4501111030521	110mm	110	5.3	250	378	8	1	pce	POA

Silenta Premium

GF Silenta premium elbow 67,5deg

- Light Grey, PP-material with inorganic filler
- According to BS EN 1451

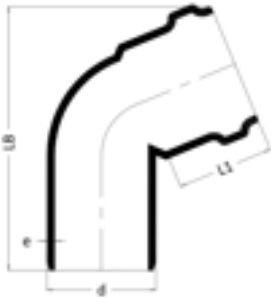

Item No.	Item no. GF	Dimensions	d mm	e mm	L1 mm	LB mm	Pallet/ Pack	Box/M QTY	UOM	Price per m/each
1146278	4501105830421	58mm	58	4.1	53	133	4	1	pce	POA
1146287	4501107830321	78mm	78	4.6	56	156	4	1	pce	POA
1146297	4501109030421	90mm	90	4.7	55	177	2	1	pce	POA
1146307	4501111030321	110mm	110	5.3	60	194	2	1	pce	POA

GF Silenta premium elbow 87,5deg

- Light Grey, PP-material with inorganic filler
- According to BS EN 1451

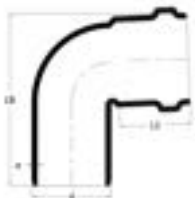

Item No.	Item no. GF	Dimensions	d mm	e mm	L1 mm	LB mm	Pallet/ Pack	Box/M QTY	UOM	Price per m/each
1146277	4501105830321	58mm	58	4.1	53	117	4	1	pce	POA
1146288	4501107830421	78mm	78	4.6	55	132	4	1	pce	POA
1146296	4501109030321	90mm	90	4.7	54	145	2	1	pce	POA
1146308	4501111030421	110mm	110	5.3	60	176	2	1	pce	POA
1146315	4501113530321	135mm	135	5.3	63	208	12	1	pce	POA
1146321	4501116030321	160mm	160	5.3	79	260	8	1	pce	POA
1146325	4501120030121	200mm	200	6.2	89	310	3	1	pce	POA

Silenta Premium

GF Silenta premium branch 45deg

- Light Grey, PP-material with inorganic filler
- According to BS EN 1451

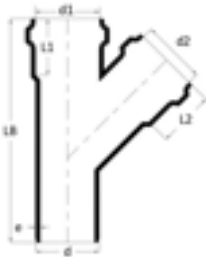

Item No.	Item no. GF	Dimensions	d/d1 mm	d2 mm	e mm	L1 mm	L2 mm	LB mm	Pallet/ Pack	Box/M QTY	UOM	Price per m/each
1146328	4501205830021	58-58mm	58	58	4.1	52	52	204	2	1	pce	POA
1146336	4501207830021	78-58mm	78	58	4.6	56	52	203	2	1	pce	POA
1146337	4501207830121	78-78mm	78	78	4.6	56	56	232	2	1	pce	POA
1146349	4501209030021	90-58mm	90	58	4.7	60	52	206	2	1	pce	POA
1146350	4501209030121	90-90mm	90	90	4.7	60	60	250	2	1	pce	POA
1146374	4501211030021	110-58mm	110	58	5.3	63	52	202	2	1	pce	POA
1146375	4501211030121	110-78mm	110	78	5.3	63	56	242	2	1	pce	POA
1146376	4501211030221	110-110mm	110	110	5.3	63	63	286	2	1	pce	POA
1146396	4501213530021	135-78mm	135	78	5.3	68	56	256	10	1	pce	POA
1146397	4501213530121	135-110mm	135	110	5.3	68	63	306	6	1	pce	POA
1146398	4501213530221	135-135mm	135	135	5.3	68	68	343	2	1	pce	POA
1146408	4501216030021	160-110mm	160	110	5.3	73	63	326	5	1	pce	POA
1146409	4501216030121	160-135mm	160	135	5.3	73	68	377	3	1	pce	POA
1146410	4501216030221	160-160mm	160	160	5.3	73	73	398	3	1	pce	POA
1146421	4501220030321	200-200mm	200	200	6.2	86	86	482	12	1	pce	POA
1146419	4501220030121	200-135mm	200	135	6.2	86	68	482	2	1	pce	POA
1146418	4501220030021	200-110mm	200	110	6.2	86	63	482	2	1	pce	POA
1146420	4501220030221	200-160mm	200	160	6.2	86	73	482	12	1	pce	POA

GF Silenta premium double branch 45deg

- Light Grey, PP-material with inorganic filler
- According to BS EN 1451

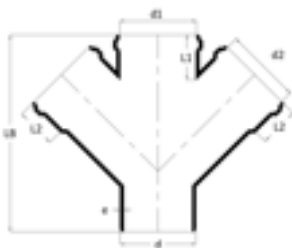

Item No.	Item no. GF	Dimensions	d/d1 mm	d2 mm	e mm	L1 mm	L2 mm	LB mm	Pallet/ Pack	Box/M QTY	UOM	Price per m/each
1146384	4501211031021	110-110mm	110	110	5.3	63	63	292	6	1	pce	POA
1146401	4501213531021	135-110mm	135	110	5.3	68	63	306	2	1	pce	POA
1146411	4501216030521	160-110mm	160	110	5.3	73	63	320	3	1	pce	POA

Silenta Premium

GF Silenta premium branch +short reducer 45deg

- Light Grey, PP-material with inorganic filler
- According to BS EN 1451

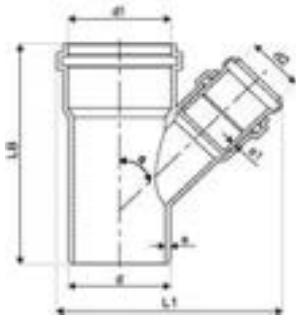

Item No.	Item no. GF	Dimensions	d/d1 mm	d2 mm	e1 mm	e mm	L1 mm	L2 mm	LB mm	remarks	Pallet/ Pack	Box/M QTY	UOM	Price per m/
1146347	4501209020021	90-50mm	90	50	4.7	3.5	200	206	90-50		2	1	pce	POA
1146372	4501211020021	110-50mm	110	50	5.3	3.5	220	202	110-50		2	1	pce	POA

GF Silenta premium branch 67,5deg

- Light Grey, PP-material with inorganic filler
- According to BS EN 1451

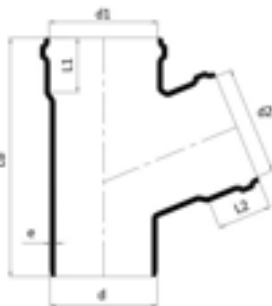

Item No.	Item no. GF	Dimensions	d/d1 mm	d2 mm	e mm	L1 mm	L2 mm	LB mm	Pallet/ Pack	Box/M QTY	UOM	Price per m/each
1146329	4501205830121	58-58mm	58	58	4.1	52	52	185	2	1	pce	POA
1146338	4501207830221	78-58mm	78	58	4.6	56	52	187	2	1	pce	POA
1146339	4501207830321	78-78mm	78	78	4.6	56	56	207	2	1	pce	POA
1146377	4501211030321	110-58mm	110	58	5.3	63	52	195	6	1	pce	POA
1146378	4501211030421	110-78mm	110	78	5.3	63	56	210	5	1	pce	POA
1146379	4501211030521	110-110mm	110	110	5.3	63	63	245	5	1	pce	POA

Silenta Premium

GF Silenta premium corner double branch radius 87,5deg

- Light Grey, PP-material with inorganic filler
- According to BS EN 1451



Item No.	Item no. GF	Dimensions	d/d1/d2 mm	e mm	L1/L2 mm	LB mm	SP	Pallet/ Pack	Box/M QTY	UOM	Price per m/each
1146356	4501209030721	90-90mm	90	4.7	55	235	12	2	1	pce	POA

GF Silenta premium branch 87,5deg

- Light Grey, PP-material with inorganic filler
- According to BS EN 1451

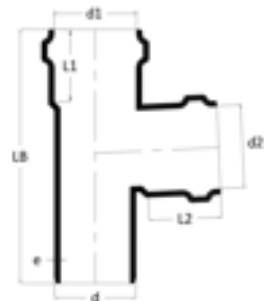

Item No.	Item no. GF	Dimensions	d/d1 mm	d2 mm	e mm	L1 mm	L2 mm	LB mm	Pallet/ Pack	Box/M QTY	UOM	Price per m/each
1146330	4501205830221	58-58mm	58	58	4.1	52	52	181	4	1	pce	POA
1146340	4501207830421	78-58mm	78	58	4.6	56	52	189	4	1	pce	POA
1146341	4501207830521	78-78mm	78	78	4.6	56	56	206	4	1	pce	POA
1146351	4501209030221	90-58mm	90	58	4.7	60	52	188	3	1	pce	POA
1146352	4501209030321	90-78mm	90	78	4.7	60	56	203	3	1	pce	POA
1146353	4501209030421	90-90mm							3	1	pce	POA
1146380	4501211030621	110-58mm	110	58	5.3	63	52	192	3	1	pce	POA
1146381	4501211030721	110-78mm	110	78	5.3	63	56	216	3	1	pce	POA
1146383	4501211030921	110-90mm							6	3	pce	POA
1146382	4501211030821	110-110mm							3	1	pce	POA
1146399	4501213530321	135-110mm	135	110	5.3	68	63	262	4	1	pce	POA
1146400	4501213530421	135-135mm	135	135	5.3	68	68	280	3	1	pce	POA
1146412	4501216031021	160-110mm	160	110	5.3	73	63	325	5	1	pce	POA
1146413	4501216031121	160-160mm	160	160	5.3	73	73	325	2	1	pce	POA

Silenta Premium

GF Silenta premium branch radius 87,5deg

- Light Grey, PP-material with inorganic filler
- According to BS EN 1451



Item No.	Item no. GF	Dimensions	d/d1 mm	d2 mm	e mm	L1 mm	L2 mm	LB mm	Pallet/ Pack	Box/M QTY	UOM	Price per m/each
1146355	4501209030621	90-90mm	90	90	4.7	60	60	236	2	1	pce	POA
1146387	4501211031321	110-90mm	110	90	5.3	63	60	241	2	1	pce	POA
1146386	4501211031221	110-110-mm	110	110	5.3	63	63	267	2	1	pce	POA

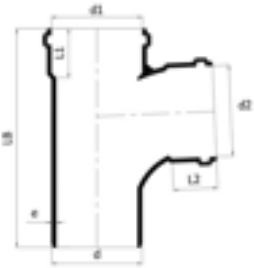

GF Silenta premium branch special 87,5deg

- Light Grey, PP-material with inorganic filler
- According to BS EN 1451



Item No.	Item no. GF	Dimensions	d2 mm	d mm	e2 mm	e mm	L1 mm	LB mm	Pallet/ Pack	Box/M QTY	UOM	Price per m/each
1146371	4501211014121	110-110-4-58mm	58	110	4.1	5.3	63	282	2	1	pce	POA
1146370	4501211013121	110-110- 5-58mm	58	110	5.3	5.3		282	2	1	pce	POA

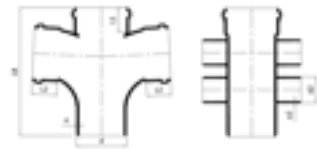

Silenta Premium

GF Silenta premium branch +short reducer 87,5deg

- Light Grey, PP-material with inorganic filler
- According to BS EN 1451



Item No.	Item no. GF	Dimensions	d/d1 mm	d2 mm	e1 mm	e mm	L1 mm	LB mm	remarks	Pallet/ Pack	Box/M QTY	UOM	Price per m/
1146348	4501209020221	90-50mm	90	50	3.5	4.7	185	188	90-50	2	1	pce	POA
1146373	4501211020621	110-50mm	110	50	3.5	5.3	206	192	110-50	3	1	pce	POA

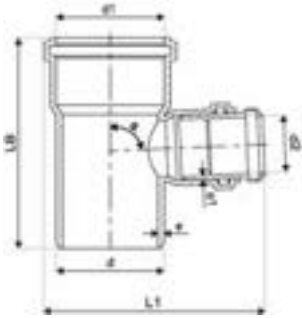

GF Silenta premium corner double branch 87,5deg

- Light Grey, PP-material with inorganic filler
- According to BS EN 1451



Item No.	Item no. GF	Dimensions	d/d1/d2 mm	e mm	L1/L2 mm	LB mm	Pallet/ Pack	Box/M QTY	UOM	Price per m/each
1146388	4501211031521	110-110mm	110	5.3	63	241	8	1	pce	POA

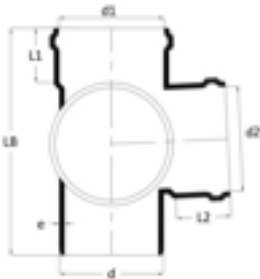

Silenta Premium

GF Silenta premium collector 87,5deg

- 4 way boss inlet connections
- Light Grey, PP-material with inorganic filler
- According to BS EN 1451

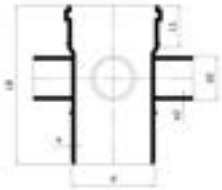

Item No.	Item no. GF	Dimensions	d2 mm	d mm	e2 mm	e mm	LB mm	Pallet/ Pack	Box/M QTY	UOM	Price per m/each
1146529	4501911031121	110-58mm (4xOut)	58	110	4.1	5.3	208.5	4	1	pce	POA

GF Silenta premium double branch radius 87,5deg

- Light grey, PP-material with inorganic filler, according to EN 1451

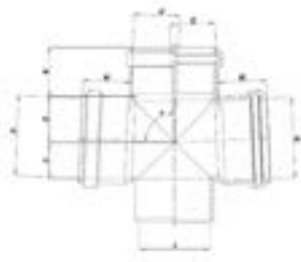

Item No.	Item no. GF	Dimensions	L mm	W mm	H mm	W kg	Pallet/ Pack	Box/M QTY	UOM	Price per m/each
1162598	4501109007021	90-90mm	110.4	261	236	0,94239	8	1	pce	POA
1162599	4501111031221	110-110mm	131.7	290.2	266.3	1,468	4	1	pce	POA

GF Silenta premium parallel branch

- Light Grey, PP-material with inorganic filler
- According to BS EN 1451

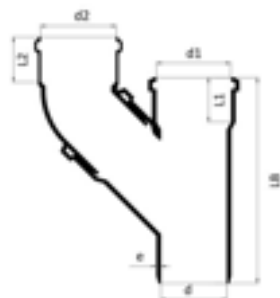

Item No.	Item no. GF	Dimensions	L mm	W mm	H mm	W kg	Pallet/ Pack	Box/M QTY	UOM	Price per m/each
1146389	4501211032021	110-110mm	135	297	336	2,143	4	1	pce	POA

Silenta Premium

GF Silenta premium reducer eccentric

- Light Grey, PP-material with inorganic filler
- According to BS EN 1451

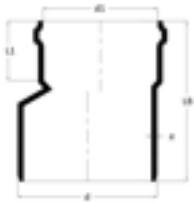

Item No.	Item no. GF	Dimensions	d1 mm	d mm	e mm	L1 mm	LB mm	remarks	Pallet/ Pack	Box/M QTY	UOM	Price per m/each
1146440	4501405830021	58-40mm	40	58	4.1	48	116	*	10	1	pce	POA
1146441	4501405830121	58-50mm	50	58	4.1	48	116	*	10	1	pce	POA
1146448	4501407830221	78-50mm	50	78	4.6	53	122	*	5	1	pce	POA
1146446	4501407830021	78-58mm	58	78	4.6	52	130		5	1	pce	POA
1146447	4501407830121	78-75mm	75	78	4.6	53	125	*	5	1	pce	POA
1146452	4501409030021	90-58mm	58	90	4.7	52	132		4	1	pce	POA
1146453	4501409030121	90-78mm	78	90	4.7	56	124		4	1	pce	POA
1146459	4501411030021	110-58mm	58	110	5.3	52	150		3	1	pce	POA
1146460	4501411030121	110-78mm	78	110	5.3	56	142		4	1	pce	POA
1146461	4501411030221	110-90mm	90	110	5.3	60	133		3	1	pce	POA
1146466	4501413530021	135-110mm	110	135	5.3	63	156		10	1	pce	POA
1146469	4501416030021	160-110mm	110	160	5.3	63	180		8	1	pce	POA
1146470	4501416030121	160-135mm	135	160	5.3	68	169		6	1	pce	POA
1146472	4501420030021	200-160mm	160	200	6.2	72	220		4	1	pce	POA

GF Silenta premium reducer concentric

- Light Grey, PP-material with inorganic filler
- According to BS EN 1451

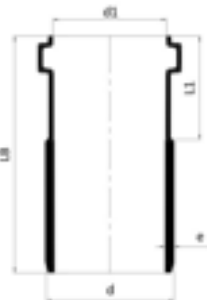

Item No.	Item no. GF	Dimensions	d1 mm	d mm	e mm	L1 mm	LB mm		Pallet/ Pack	Box/M QTY	UOM	Price per m/each
1146508	4501905830121	58-50mm	50	58	4.1	48	106		4	1	pce	POA
1146514	4501907830121	78-75mm	75	78	4.6	53	116		3	1	pce	POA
1146535	4501913530121	135-125mm	125	135	5.3	73	147		10	1	pce	POA

GF Silenta premium reducer short eccentric

- Light Grey, PP-material with inorganic filler
- According to BS EN 1451



Item No.	Item no. GF	Dimensions	d1 mm	d mm	e mm	L1 mm	LB mm		Pallet/ Pack	Box/M QTY	UOM	Price per m/each
1146442	4501405830321	58-50mm	50	58	3.5	45	70.0		4	1	pce	POA
1146449	4501407830421	78-58mm	58	78	4.6	51	81.0		4	1	pce	POA
1146454	4501409030221	90-58mm	58	90	4.7	50	82.0		5	1	pce	POA
1146455	4501409030321	90-78mm	78	90	4.7	50	82.0		4	1	pce	POA
1146464	4501411030521	110-58mm	58	110	5.3	50	85.0		5	1	pce	POA
1146463	4501411030421	110-78mm	78	110	5.3	55	85.0		5	1	pce	POA
1146462	4501411030321	110-90mm	90	110	5.3	55	87.5		4	1	pce	POA

Silenta Premium

GF Silenta premium access pipe circular

- Fitting with circular, screw access cap for easy internal inspections
- Light Grey, PP-material with inorganic filler
- According to BS EN 1451



Item No.	Item no. GF	Dimensions	d/d1 mm	e mm	L1 mm	LB mm	Pallet/ Pack	Box/M QTY	UOM	Price per m/each
1146423	4501305830021	58mm	58	4.1	52	188	15	1	pce	POA
1146425	4501307830021	78mm	78	4.6	56	240	12	1	pce	POA
1146427	4501309030021	90mm	90	4.7	60	216	8	1	pce	POA



GF Silenta premium socket plug

- Push-fit socket plug to stop open ends
- Light Grey, PP-material with inorganic filler
- According to BS EN 1451



Item No.	Item no. GF	Dimensions	d mm	e mm	LB mm	Pallet/ Pack	Box/M QTY	UOM	Price per m/each
1146507	4501905830021	58mm	58	4.1	67	10	1	pce	POA
1146513	4501907830021	78mm	78	4.6	70	5	1	pce	POA
1146518	4501909030021	90mm	90	4.7	56	5	1	pce	POA
1146524	4501911030021	110mm	110	5.3	73	4	1	pce	POA
1146534	4501913530021	135mm	135	5.3	78	20	1	pce	POA
1146538	4501916030021	160mm	160	5.3	88	12	1	pce	POA

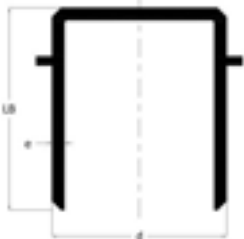

Silenta Premium

GF Silenta premium socket

- Light Grey, PP-material with inorganic filler
- According to BS EN 1451

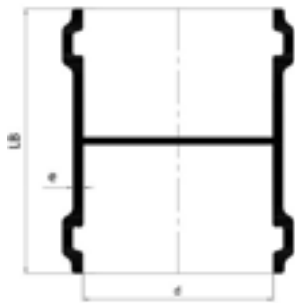

Item No.	Item no. GF	Dimensions	d mm	e mm	LB mm	Pallet/ Pack	Box/M QTY	UOM	Price per m/each
1146475	4501505830021	58mm	58	4.1	105	4	1	pce	POA
1146479	4501507830021	78mm	78	4.6	110	3	1	pce	POA
1146482	4501509030021	90mm	90	4.7	115	3	1	pce	POA
1146486	4501511030021	110mm	110	5.3	120	3	1	pce	POA
1146490	4501513530021	135mm	135	5.3	128	10	1	pce	POA
1146494	4501516030021	160mm	160	5.3	141	12	1	pce	POA
1146498	4501520030021	200mm	200	6.2	205	3	1	pce	POA

GF Silenta premium sleeve socket

- Sleeve socket for simple in-line connections and repairs
- Light Grey, PP-material with inorganic filler
- According to BS EN 1451

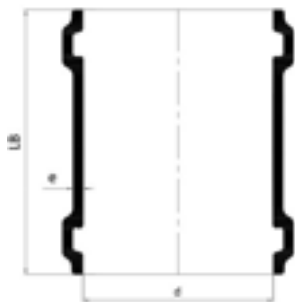

Item No.	Item no. GF	Dimensions	d mm	e mm	LB mm	Pallet/ Pack	Box/M QTY	UOM	Price per m/each
1146476	4501505830121	58mm	58	4.1	105	4	1	pce	POA
1146480	4501507830121	78mm	78	4.6	110	3	1	pce	POA
1146483	4501509030121	90mm	90	4.7	115	3	1	pce	POA
1146487	4501511030121	110mm	110	5.3	120	3	1	pce	POA
1146491	4501513530121	135mm	135	5.3	128	10	1	pce	POA
1146495	4501516030121	160mm	160	5.3	141	12	1	pce	POA
1146499	4501520030121	200mm	200	6.2	205	3	1	pce	POA

GF Silenta premium access pipe rectangular

- Fitting with rectangular access cap for easy internal inspections
- Light Grey, PP-material with inorganic filler
- According to BS EN 1451

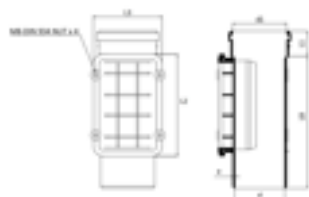

Item No.	Item no. GF	Dimensions	d/d1 mm	e mm	L1 mm	L2 mm	L3 mm	LB mm	Pallet/ Pack	Box/M QTY	UOM	Price per m/each
1146431	4501311030021	110mm	110	5.3	54	220	140	350	10	1	pce	POA
1146433	4501313530021	135mm	135	5.3	59	255	175	390	6	1	pce	POA
1146437	4501316030021	160mm	160	5.3	63	275	195	407	2	1	pce	POA

Silenta Premium

GF Silenta premium repair pipe

- Repair socket/length for 110mm
- Light Grey, PP-material with inorganic filler
- According to BS EN 1451

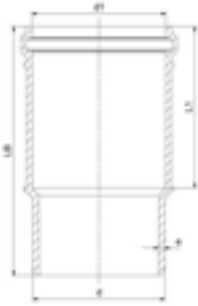

Item No.	Item no. GF	Dimensions	d/d1 mm	e mm	L1 mm	LB mm	Pallet/ Pack	Box/M QTY	UOM	Price per m/each
1146526	4501911030621	110mm	110	5.3	128	196	2	1	pce	POA

GF Silenta premium siphon elbow 90deg

- Light Grey, PP-material with inorganic filler
- According to BS EN 1451

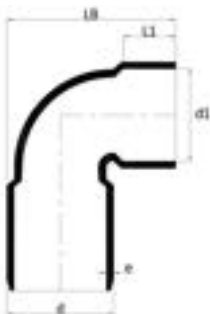

Item No.	Item no. GF	Dimensions	d1 mm	d mm	e mm	L1 mm	LB mm	Pallet/ Pack	Box/M QTY	UOM	Price per m/each
1146279	4501105830821	58-40mm	50	58	4.1	30	92	4	1	pce	POA

Silenta 3A



Silenta 3A sound-insulated waste-water pipe system provides a complete solution with a high level of sound protection combined with high durability, impact resistance, and easy installation.

Made of specially formulated and reinforced PP material, the three-layer drainage pipe system is designed for gravity-fed domestic drainage and complies with BS EN 1451.

Available in diameters DN 32 to DN 200, Silenta 3A offers excellent chemical and temperature resistance, and comes with a full range of fittings, ensuring a long-lasting, safe, and comfortable drainage solution.

Specification

- Manufactured with the latest generation of multilayer (three different layers) polypropylene technology
- System according to the requirements of BS EN 1451
- Application are B to BS EN 1451
- 15 db(A) at 4l/s - tested to BS EN 14366
- Fire class D - s2, d2 to BS EN 13501-1
- Pipe diameters from 32 mm to 200 mm
- Wide range of fittings to give complete design freedom
- For use with GF Silent Clamp range

Benefits

Silenta 3A provides very good sound insulation, removing unwanted noise from the wastewater system and enhancing user comfort in the property.

- Suitable for hot and cold water and acidic liquids
- A lightweight, reliable alternative to cast iron pipes
- Free from halogens and does not release halogenic gases in event of fire
- 100% recyclable and environmentally friendly
- Corrosion-free and highly durable
- Light blue Colour makes internal inspection easy

Application

Applications:

Silenta 3A is suitable for various wastewater types and areas of use, including:

- High end residential, multi-family residential, hotels, healthcare, restaurants, etc
- Sustainable/green buildings
- Industrial facilities (short- and long-term use)
- Domestic sewage and rainwater
- Wastewater from kitchens, bathrooms, laundry rooms, toilets, and similar spaces

Commercial/Industrial Wastewater:

- For untreated wastewater containing harmful substances
- Guidance relating to chemical resistance of Polypropylene can be sought from ISO/TR 10358
- For full system chemical compatibility please contact GF
- Required details for assessment:
 - Substance composition
 - Concentration and pH values
 - Quantities and flow rates
 - Wastewater temperature

Certification

- BBA (Pending)

Silenta 3A

GF Silenta 3A pipe with single socket

- Light blue, three-layer, PP-material with inorganic filler
- According to BS EN 1451

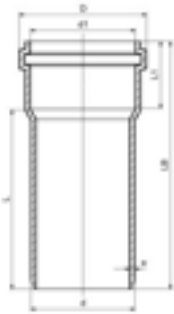

Item No.	Item no. GF	In/Out	Dimensions	d/d1 mm	D mm	DN mm	e mm	L1 mm	L mm	LB mm	S	Pallet/ Pack	Box/M QTY	UOM	Price per m/
1146567	4604003200621		32x3000mm									250	1	pce	POA
1146568	4604004000121		40x150mm	40	54.2	40	1.8	45	150	195	16	300	1	pce	POA
1146569	4604004000321		40x500mm	40	54.2	40	1.8	45	500	545	16	150	1	pce	POA
1146570	4604004000421		40x1000mm	40	54.2	40	1.8	45	1000	1045	16	160	1	pce	POA
1146571	4604004000521		40x2000mm	40	54.2	40	1.8	45	2000	2045	16	160	1	pce	POA
1146572	4604004000621		40x3000mm	40	54.2	40	1.8	45	3000	3045	16	160	1	pce	POA
1147145	4604005010121		50x150mm									200	1	pce	POA
1147146	4604005010221		50x250mm									150	1	pce	POA
1147147	4604005010321		50x500mm									90	1	pce	POA
1147148	4604005010421		50x1000mm									90	1	pce	POA
1147149	4604005010521		50x2000mm									90	1	pce	POA
1147150	4604005010621		50x3000mm									90	1	pce	POA
1147151	4604007510121		75x150mm									100	1	pce	POA
1147152	4604007510221		75x250mm									70	1	pce	POA
1147153	4604007510321		75x500mm									40	1	pce	POA
1147154	4604007510421		75x1000mm									70	1	pce	POA
1147155	4604007510521		75x2000mm									70	1	pce	POA
1147156	4604007510621		75x3000mm									70	1	pce	POA
1185505	4704009005021	03.26	90x150mm									28	1	pce	POA
1185506	4704009005121	03.26	90x250mm									20	1	pce	POA
1185507	4604009005221	03.26	90x500mm									12	1	pce	POA
1185508	4604009005321	03.26	90x1000mm									60	1	pce	POA
1185509	4604009005421	03.26	90x2000mm									60	1	pce	POA
1185510	4604009005521	03.26	90x3000mm									60	1	pce	POA
1147157	4604011010121		110x150mm									45	1	pce	POA
1147158	4604011010221		110x250mm									35	1	pce	POA
1147159	4604011010321		110x500mm									20	1	pce	POA
1147160	4604011010421		110x1000mm									40	1	pce	POA
1147161	4604011010521		110x2000mm									40	1	pce	POA
1147162	4604011010621		110x3000mm									40	1	pce	POA
1147164	4604012510121		125x150mm									40	1	pce	POA
1147165	4604012510221		125x250mm									20	1	pce	POA
1147166	4604012510321		125x500mm									16	1	pce	POA
1147167	4604012510421		125x1000mm									24	1	pce	POA
1147168	4604012510521		125x2000mm									24	1	pce	POA
1147169	4604012510621		125x3000mm									24	1	pce	POA
1147170	4604016010121		160x150mm									24	1	pce	POA
1147171	4604016010221		160x250mm									14	1	pce	POA
1147172	4604016010321		160x500mm									8	1	pce	POA

Silenta 3A

GF Silenta 3A elbow 15deg

- Light blue, PP-material with inorganic filler
- According to BS EN 1451

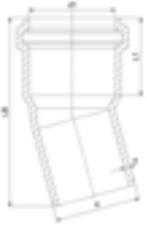

Item No.	Item no. GF	In/Out	Dimensions	d/d1 mm	DN mm	e mm	L1 mm	LB mm	S	Pallet/ Pack	Box/M QTY	UOM	Price per m/each
1146642	4704103200121		32mm							500	1	pce	POA
1146645	4704104000121		40mm							500	1	pce	POA
1146648	4704105000121		50mm	50	50	1.8	46	110.2	16	300	1	pce	POA
1146653	4704107500621		75mm	75	75	2.3	51	130.5	16	150	1	pce	POA
1185525	4704109030021	03.26	90mm							39	1	pce	POA
1146658	4704111001121		110mm	110	110	3.4	58	161.7	20	60	1	pce	POA
1146665	4704116001121		160mm	160	160	4.9	73	185.9	16	20	1	pce	POA

GF Silenta 3A elbow 30deg

- Light blue, PP-material with inorganic filler
- According to BS EN 1451



Item No.	Item no. GF	In/Out	Dimensions	d/d1 mm	DN mm	e mm	L1 mm	LB mm	S	Pallet/ Pack	Box/M QTY	UOM	Price per m/each
1146649	4704105000221		50mm	50	50	1.8	46	116.8	16	350	1	pce	POA
1146654	4704107500721		75mm	75	75	2.3	51	142.2	16	150	1	pce	POA
1185526	4704109030121	03.26	90mm							39	1	pce	POA
1146659	4704111001221		110mm	110	110	3.4	58	180.3	16	60	1	pce	POA
1146666	4704116001221		160mm	160	160	4.9	73	216.6	16	20	1	pce	POA

Silenta 3A

GF Silenta 3A elbow 45deg

- Light blue, PP-material with inorganic filler
- According to BS EN 1451

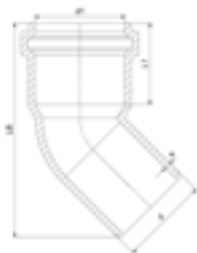

Item No.	Item no. GF	In/Out	Dimensions	d/d1 mm	DN mm	e mm	L1 mm	LB mm	S	Pallet/ Pack	Box/M QTY	UOM	Price per m/each
1146643	4704103200321		32mm							1000	1	pce	POA
1146646	4704104000321		40mm							30	1	pce	POA
1146650	4704105000321		50mm	50	50	1.8	46	118.9	16	150	1	pce	POA
1146656	4704107500921		75mm	75	75	2.3	51	147.8	16	50	1	pce	POA
1185527	4704109030221	03.26	90mm							32	1	pce	POA
1146660	4704111001321		110mm	110	110	3.4	58	190.8	16	50	1	pce	POA
1146663	4704112501621		125mm	125	125	3.9	64	198.3	16	15	1	pce	POA
1146667	4704116001821		160mm	160	160	4.9	73	258.1	16	6	1	pce	POA
1146669	4704120002021		200mm	200	200	6.2	85	310.9	16	10	1	pce	POA

GF Silenta 3A elbow 67,5deg

- Light blue, PP-material with inorganic filler
- According to BS EN 1451

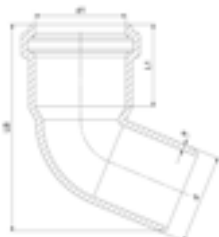

Item No.	Item no. GF	In/Out	Dimensions	d/d1 mm	DN mm	e mm	L1 mm	LB mm	S	Pallet/ Pack	Box/M QTY	UOM	Price per m/each
1146651	4704105000421		50mm	50	50	1.8	46	113.1	16	300	1	pce	POA
1146655	4704107500821		75mm	75	75	2.3	51	144.2	16	150	1	pce	POA
1185528	4704109030321	03.26	90mm							32	1	pce	POA
1146661	4704111001421		110mm	110	110	3.4	58	189.9	16	50	1	pce	POA

GF Silenta 3A elbow 87,5deg

- Light blue, PP-material with inorganic filler
- According to BS EN 1451

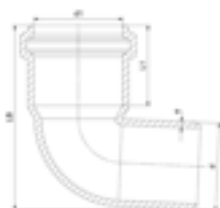

Item No.	Item no. GF	In/Out	Dimensions	d/d1 mm	DN mm	e mm	L1 mm	LB mm	S	Pallet/ Pack	Box/M QTY	UOM	Price per m/each
1146644	4704103200421		32mm							500	1	pce	POA
1146647	4704104000521		40mm							450	1	pce	POA
1146652	4704105000521		50mm	50	50	1.8	46	101.3	16	140	1	pce	POA
1146657	4704107501021		75mm	75	75	2.3	51	131.0	16	50	1	pce	POA
1185529	4704109030421	03.26	90mm							32	1	pce	POA
1146662	4704111001521		110mm	110	110	3.4	58	174.2	16	40	1	pce	POA
1146664	4704112501721		125mm	125	125	3.9	64	192.7	16	10	1	pce	POA
1146668	4704116001921		160mm	160	160	4.9	73	244.8	16	6	1	pce	POA
1146670	4704120002121		200mm	200	200	6.2	85	304.0	16	6	1	pce	POA

Silenta 3A

GF Silenta 3A parallel branch AMS 87,5deg

- Light blue, PP-material with inorganic filler
- According to BS EN 1451



Item No.	Item no. GF	In/Out	Dimensions	l2 mm	l3 mm	l4 mm	d mm	d1 mm	d2 mm	e mm	l1 mm	LB mm	Pallet/ Pack	Box/M QTY	UOM	Price per m/
1185536	4704209042021	03.26	90-50mm	60,2	55	47,7	89,7	90,3	90,3	2,8	55	345	4	1	pce	POA
1185535	4704209032021	03.26	90-90mm	54,6			89,9	90,5	91,5	2,8	55	222	4	1	pce	POA

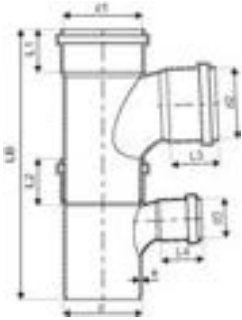

Silenta 3A

GF Silenta 3A branch 45deg

- Light blue, PP-material with inorganic filler
- According to BS EN 1451

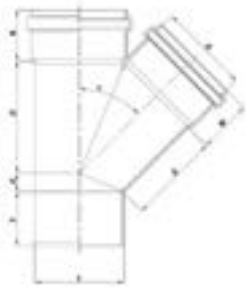

Item No.	Item no. GF	In/Out	Dimensions	d/d1 mm	d2 mm	DN mm	e mm	L1 mm	L2 mm	LB mm	S	Pallet/ Pack	Box/M QTY	UOM	Price per m/
1146671	4704203200121		32-32mm									250	1	pce	POA
1146672	4704204000121		40-40mm									30	1	pce	POA
1146674	4704205000121		50-50mm	50	50	50-50	1.8	46	46	175.0	16	50	1	pce	POA
1146677	4704207500221		75-50mm	75	50	75-50	2.3	51	46	180.0	16	20	1	pce	POA
1146678	4704207500321		75-75mm	75	75	75-75	2.3	51	51	216.0	16	10	1	pce	POA
1185511	4704209000121	03.26	90-50mm									8	1	pce	POA
1185512	4704209000221	03.26	90-75mm									14	1	pce	POA
1185530	4704209030421	03.26	90-90mm									14	1	pce	POA
1146682	4704211000421		110-50mm	110	50	110-50	3.4	58	46	202.0	16	40	1	pce	POA
1146683	4704211000521		110-75mm	110	75	110-75	3.4	58	51	237.0	16	30	1	pce	POA
1185513	4704211001521	03.26	110-90mm									10	1	pce	POA
1146684	4704211000621		110-110mm	110	110	110-110	3.4	58	58	288.0	16	20	1	pce	POA
1146691	4704212500721		125-50mm	125	50	125-50	3.1	64	46	210.0	20	15	1	pce	POA
1146692	4704212500821		125-75mm	125	75	125-75	3.1	64	51	290.0	20	10	1	pce	POA
1146693	4704212500921		125-110mm	125	110	125-110	3.9	64	58	297.0	16	8	1	pce	POA
1146694	4704212501021		125-125mm	125	125	125-125	3.1	64	64	320.0	20	6	1	pce	POA
1146697	4704216001121		160-110mm	160	110	160-110	4.9	73	58	326.0	16	10	1	pce	POA
1146698	4704216001221		160-125mm	160	125	160-125	3.1	73	64	377.0	20	10	1	pce	POA
1146704	4704220001421		200-110mm	200	110	200-110	6.2	85	58	482.0	20	4	1	pce	POA
1146705	4704220001521		200-125mm	200	125	200-125	6.2	85	64	482.0	20	4	1	pce	POA

Silenta 3A

GF Silenta 3A branch 87,5deg

- Light blue, PP-material with inorganic filler
- According to BS EN 1451



Item No.	Item no. GF	Dimensions	d/d1 mm	d2 mm	DN mm	e mm	L1 mm	L2 mm	LB mm	S	Pallet/ Pack	Box/M QTY	UOM	Price per m/
1146673	4704204000221	40-40mm									200	1	pce	POA
1146675	4704205001821	50-50mm	50	50	50-50	1.8	46	46	155	16	30	1	pce	POA
1146679	4704207501921	75-50mm	75	50	75-50	2.3	51	46	180	16	10	1	pce	POA
1146680	4704207502021	75-75mm	75	75	75-75	1.9	51	51	216	20	15	1	pce	POA
1146685	4704211002121	110-50mm	110	50	110-50	3.4	58	46	183	16	50	1	pce	POA
1146686	4704211002221	110-75mm	110	75	110-75	3.4	58	51	243	16	15	1	pce	POA
1146687	4704211002321	110-110mm	110	110	110-110	3.4	58	58	245	16	10	1	pce	POA
1146696	4704212503921	125-125mm	125	125	125-125	3.1	64	64	280	20	4	1	pce	POA
1146701	4704216002621	160-110mm	160	110	160-110	4.9	73	58	325	16	14	1	pce	POA
1146700	4704216001421	160-160mm	160	160	160-160	4.9	73	73	325	16	10	1	pce	POA

Silenta 3A

GF Silenta 3A branch radius 87,5deg

- Light blue, PP-material with inorganic filler
- According to BS EN 1451



Item No.	Item no. GF	In/Out	Dimensions	l2 mm	α Degree	d mm	d1 mm	d2 mm	e mm	l1 mm	LB mm	Pallet/ Pack	Box/M QTY	UOM	Price per m/
1185514	4704209001321	03.26	90-50mm	48,5	87,5	90	90,6	63,7	2,8	55	180	8	1	pce	POA
1185515	4704209001421	03.26	90-75mm	51,4	87,5	90	90,6	75,6	2,8	55	210	18	1	pce	POA
1185516	4704209000521	03.26	90-90mm	55	87,5	90	90,3	90,3	2,8	55	222	16	1	pce	POA
1185519	4704211031321	03.26	110-90mm	53,9	87,5	110	111	90,8	3,4	58	250	12	1	pce	POA

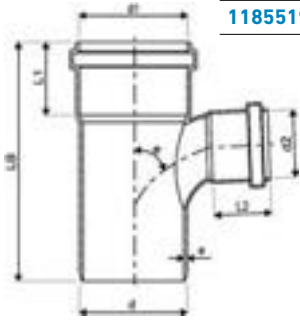

GF Silenta 3A double branch 45deg

- Light blue, PP-material with inorganic filler
- According to BS EN 1451



Item No.	Item no. GF	Dimensions	d/d1 mm	d2 mm	DN mm	e mm	L1 mm	L2 mm	LB mm	S	Pallet/ Pack	Box/M QTY	UOM	Price per m/
1146676	4704205003021	50-50mm	50	50	50-50	1.8	46	46	175	16	15	1	pce	POA
1146681	4704207503121	75-50mm	75	50	75-50	1.9	51	46	180	20	15	1	pce	POA
1146689	4704211003221	110-50mm	110	50	110-50	2.7	58	46	202	20	7	1	pce	POA
1146690	4704211003421	110-110mm	110	110	110-110	3.4	58	58	290	16	6	1	pce	POA
1146702	4704216003621	160-110mm	160	110	160-110	3.1	73	58	326	20	8	1	pce	POA

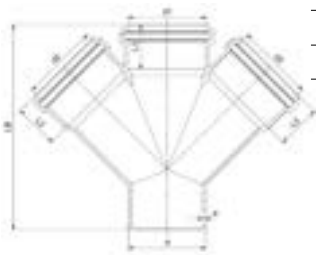

Silenta 3A

GF Silenta 3A double branch 87,5deg

- Light blue, PP-material with inorganic filler
- According to BS EN 1451



Item No.	Item no. GF	Dimensions	d/d1 mm	d2 mm	DN mm	e mm	L1 mm	L2 mm	LB mm	S	Pallet/ Pack	Box/M QTY	UOM	Price per m/
1146688	4704211002521	110-110mm	110	110	110-110	3,4	58	58	241	16	20	1	pce	POA

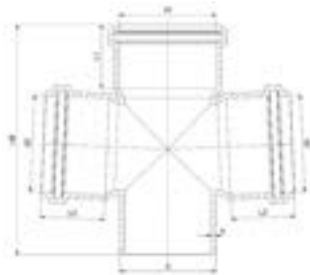

GF Silenta 3A double branch radius 87,5deg

- Radiu branch for improved flow efficiency
- Light blue, PP-material with inorganic filler
- According to BS EN 1451



Item No.	Item no. GF	In/Out	Dimensions	α Degree	d mm	d1 mm	d2 mm	e mm	M mm	z1 mm	z2 mm	z3 mm	Pallet/ Pack	Box/M QTY	UOM	Price per m/
1185518	4704209002121	03.26	90-90mm	87,5	85,3	93,8	90,5	2,8	55	64,8	72,5	44,3	8	1	pce	POA
1185520	4704211031221	03.26	110-110mm	87,5	104,2	113,6	110,5	3,2	55	87,3	82,6	53,2	4	1	pce	POA

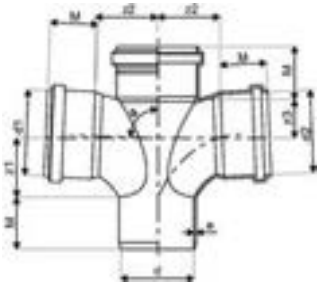

Silenta 3A

GF Silenta 3A corner double branch 87,5deg

- Light blue, PP-material with inorganic filler
- According to BS EN 1451

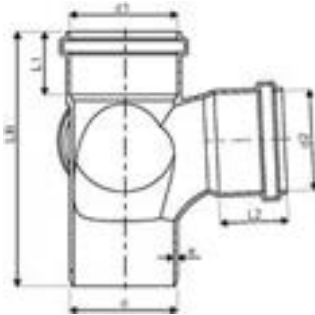

Item No.	Item no. GF	In/Out	Dimensions	l1 mm	l2 mm	d mm	d1 mm	d2 mm	e mm	z1 mm	z2 mm	z3 mm	H mm	LB mm	Pallet/ Pack	Box/M QTY	UOM	Price per m/
1185517	4704209001121	03.26	90-90mm	55	55	86,6	87,5	87,5	2,9					222	12	1	pce	POA
1147222	4704211003021		110-110mm			103,2	110,6	110,6	52,7	62	58,5	222,1		20	1	pce	POA	

Silenta 3A

GF Silenta 3A reducer eccentric

- Light blue, PP-material with inorganic filler
- According to BS EN 1451



Item No.	Item no. GF	In/Out	Dimensions	d1 mm	d mm	DN mm	e mm	L1 mm	LB mm	S	Pallet/ Pack	Box/M QTY	UOM	Price per m/
1146711	4704404000521		40x32mm								750	1	pce	POA
1146712	4704405000021		50-32mm	32	50	50-32	1.8	46	111	16	500	1	pce	POA
1146713	4704405000121		50x40mm	40	50	50-40	1.8	46	116	16	30	1	pce	POA
1146714	4704407500121		75-50mm	50	75	75-50	2.3	51	124	16	100	1	pce	POA
1185522	4704409000121	03.26	90-50mm								32	1	pce	POA
1185523	4704409000221	03.26	90-75mm								32	1	pce	POA
1146715	4704411000221		110-50mm	50	110	110-50	3.4	58	155	16	50	1	pce	POA
1146716	4704411000321		110-75mm	75	110	110-75	3.4	58	143	16	40	1	pce	POA
1185524	4704411000621	03.26	110-90mm								18	1	pce	POA
1146717	4704412500421		125-110mm	110	125	125-110	3.1	64	145	20	25	1	pce	POA
1146718	4704416000521		160-110mm	110	160	160-110	4.9	73	180	16	20	1	pce	POA
1146719	4704416000721		160-125mm	125	160	160-125	3.9	73	182	20	20	1	pce	POA
1146720	4704420000621		200-160mm	160	200	200-160	4.9	85	220	20	10	1	pce	POA

GF Silenta 3A socket

- Light blue, PP-material with inorganic filler
- According to BS EN 1451

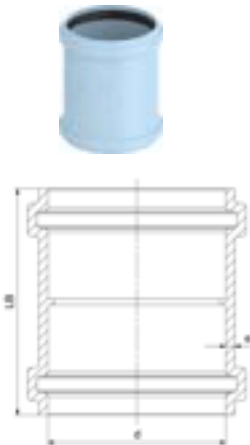

Item No.	Item no. GF	In/Out	Dimensions	d mm	DN mm	e mm	LB mm	S	Pallet/ Pack	Box/M QTY	UOM	Price per m/each
1147244	4704503200121		32mm						600	1	pce	POA
1146721	4704504000121		40mm						600	1	pce	POA
1146722	4704505000121		50mm	50	50	1.8	92	16	50	1	pce	POA
1146724	4704507500221		75mm	75	75	1.9	100	20	20	1	pce	POA
1185532	4704509030021	03.26	90mm						18	1	pce	POA
1146726	4704511000321		110mm	110	110	3.4	120	16	10	1	pce	POA
1146729	4704516000421		160mm	160	160	4.9	141	16	6	1	pce	POA
1146731	4704520000521		200mm	200	200	4.9	205	20	12	1	pce	POA

Silenta 3A

GF Silenta 3A sleeve socket

- Sleeve socket for easy in-line connections and repairs
- Light blue, PP-material with inorganic filler
- According to BS EN 1451

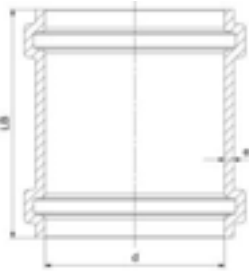

Item No.	Item no. GF	In/Out	Dimensions	d mm	DN mm	e mm	LB mm	S	Pallet/Pack	Box/M QTY	UOM	Price per m/each
1146723	4704505000221		50mm	50	50	1.8	92	16	50	1	pce	POA
1185533	4704509030121	03.26	90mm						18	1	pce	POA
1146727	4704511000421		110mm	110	110	3.4	120	16	8	1	pce	POA

GF Silenta 3A socket plug

- Push-fit socket plug to stop open ends
- Light blue, PP-material with inorganic filler
- According to BS EN 1451

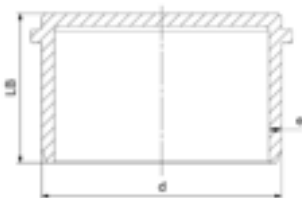

Item No.	Item no. GF	In/Out	Dimensions	d mm	DN mm	e mm	LB mm	S	Pallet/Pack	Box/M QTY	UOM	Price per m/each
1147251	4704904000221		40mm						1000	1	pce	POA
1146738	4704905000421		50mm	50	50	1.8	46	16	125	1	pce	POA
1146739	4704907500121		75mm	75	75	1.9	50	20	50	1	pce	POA
1185531	4704909030021	03.26	90mm						50	1	pce	POA
1146740	4704911000221		110mm	110	110	2.7	55	20	25	1	pce	POA
1146744	4704916000321		160mm	160	160	4.9	88	16	12	1	pce	POA

GF Silenta 3A S-siphon 45deg

- Light blue, PP-material with inorganic filler
- According to BS EN 1451

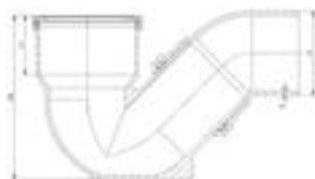

Item No.	Item no. GF	Dimensions	d mm	DN mm	e mm	L1 mm	LB mm	S	Pallet/Pack	Box/M QTY	UOM	Price per m/each
1146733	4704607500121	75mm	75	75	2.3	48.2	148.5	16	20	1	pce	POA
1146735	4704611000121	110mm	110	110	3.4	72.0	208.5	16	6	1	pce	POA

Silenta 3A

GF Silenta 3A S-siphon 87,5deg

- Light blue, PP-material with inorganic filler
- According to BS EN 1451



Item No.	Item no. GF	Dimensions	d mm	DN mm	e mm	L1 mm	LB mm	S	Pallet/ Pack	Box/M QTY	UOM	Price per m/each
1146734	4704607500221	75mm	75	75	2.3	48.2	148.5	16	50	1	pce	POA
1146736	4704611000221	110mm	110	110	3.4	72.0	208.5	16	5	1	pce	POA

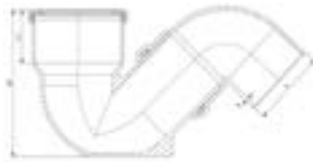

GF Silenta 3A access pipe circular

- Fitting with circular screw cap for easy inspection
- Light blue, PP-material with inorganic filler
- According to BS EN 1451



Item No.	Item no. GF	In/Out	Dimensions	d/d1 mm	DN mm	e mm	L1 mm	S	Pallet/ Pack	Box/M QTY	UOM	Price per m/each
1146709	4704311000421		75mm	75	75	1.9	216	20	15	1	pce	POA
1185534	4704309030021	03.26	90mm						8	1	pce	POA
1146708	4704311000121		110mm	110	110	3.4	245	16	6	1	pce	POA

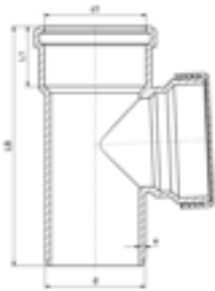

Silenta 3A

GF Silenta 3A access pipe rectangular

- Fitting with rectangular cap for easy inspection
- Light blue, PP-material with inorganic filler
- According to BS EN 1451



Item No.	Item no. GF	Dimensions	d/d1 mm	DN mm	e mm	L1 mm	L2 mm	L3 mm	LB mm	S	Pallet/ Pack	Box/M QTY	UOM	Price per m/
1146710	4704316000221	160mm	160	160	4.9	73	275	195	412.1	16	8	1	pce	POA

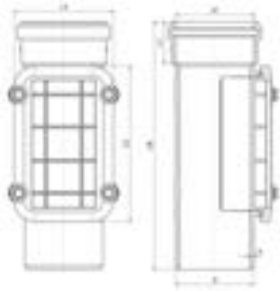

Silenta



Benefits

- Silenta system installation components
- Optimized acoustic performance
- Reliable fixing and sealing
- Flexible installation solutions

Silenta accessories are the ideal system fittings necessary to ensure a high performance and durable installation for all GF Silenta drainage systems.

Application

Applications:

Silenta items are suitable for wastewater systems within:

- High end residential, multi-family residential, hotels, healthcare, restaurants, etc
- Sustainable/green buildings
- Industrial facilities (short- and long-term use)
- Domestic sewage and rainwater
- Wastewater from kitchens, bathrooms, laundry rooms, toilets, and similar spaces

Specification

- System accessories developed specifically for GF Silenta drainage systems
- Includes fixing components such as acoustic pipe clamps, safety clamps and fastening elements
- Includes sealing and connection components such as gaskets, rubber seals and transition adapters
- Designed to preserve the acoustic performance according to BS EN 14366

GF Silenta seal rubber mol

- Rubber Seal for Silenta System



Item No.	Item no. GF	Dimensions	L mm	W mm	H mm	W kg	Pallet/ Pack	Box/M QTY	UOM	Price per m/each
1159801	1410903201292	32mm	40	40	6	0,01		1	pce	POA
1150059	1410904001292	40mm	52	52	8	0,01	38454	1	pce	POA
1150060	1410905001292	50mm	65	65	8	0,007	26418	1	pce	POA
1146169	1410905800392	58mm	70	70	9	0,01	10	1	pce	POA
1150062	1410907501292	75mm	90	90	8	0,01	20000	1	pce	POA
1146171	1410907800492	78mm	90	90	8	0,01108	10764	1	pce	POA
1150065	1410909000492	90mm	105	105	9	0,01413	8736	1	pce	POA
1150068	1410911001392	110mm	125	125	11	0,02149	4524	1	pce	POA
1146174	1410913501492	135mm	155	155	13	0,038		1	pce	POA
1150071	1410916001592	160mm	180	180	14	0,05655	1736	1	pce	POA
1150072	1410920000792	200mm	225	225	14	0,07716	1080	1	pce	POA

GF Silenta clamp silence double

- Sound absorbing bracket
- For vertical installation of Silenta 3A products



Item No.	Item no. GF	Dimensions	L mm	W mm	H mm	W kg	Pallet/ Pack	Box/M QTY	UOM	Price per m/each
1146150	1300905030412	50mm	60	60	30	0,2505	20	1	pce	POA
1146159	1300912530412	125mm	135	135	80	0,667	10	1	pce	POA



GF Silenta clamp silence double

- Sound absorbing bracket
- For vertical installation of Silenta 3A and Sailenta Premium products



Item No.	Item no. GF	Dimensions	L mm	W mm	H mm	W kg	Pallet/ Pack	Box/M QTY	UOM	Price per m/each
1146154	1300907530412	75-78mm	80	80	60	0,3753	15	1	pce	POA
1146156	1300911030412	110mm	120	120	60	0,69	10	1	pce	POA
1146164	1300916030412	160mm	180	180	80	1,1857	7	1	pce	POA
1146166	1300920030412	200mm	250	250	80	1,944	5	1	pce	POA



GF Silenta clamp silence double

- Sound absorbing bracket
- For vertical installation of Silenta Premium products



Item No.	Item no. GF	Dimensions	L mm	W mm	H mm	W kg	Pallet/ Pack	Box/M QTY	UOM	Price per m/each
1146152	1300905830412	58mm	60	60	60	0,2505	20	1	pce	POA
1146161	1300913530412	135mm	135	135	80	0,667	10	1	pce	POA



GF Silenta seal rubber mono lip

- Rubber Seal for Silenta System

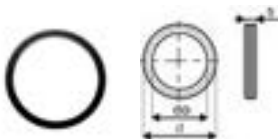

Item No.	Item no. GF	Dimensions	L mm	W mm	H mm	W kg	Pallet/ Pack	Box/M QTY	UOM	Price per m/each
1159803	1410905000391	50mm	62	62	4	0,0085	3000	1	pce	POA
1159809	1410907500391	75mm	85	85	9	0,013	2000	1	pce	POA
1159820	1410911000391	110mm	125	125	9	0,0189	1300	1	pce	POA

Silenta

GF Silenta safety clamp

- GF Silenta safety overclamp for added joint security

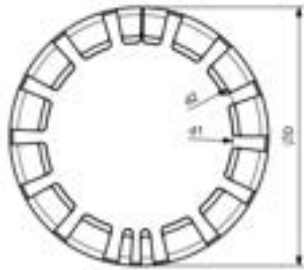

Item No.	Item no. GF	Dimensions	L mm	W mm	H mm	W kg	Pallet/ Pack	Box/M QTY	UOM	Price per m/each
1146506	4501905820382	58mm	7.8	58	3	0,3		1	pce	POA
1146512	4501907826282	78mm	10	78	3	0,4	10	1	pce	POA
1146516	4501909026282	90mm	11	90	3	0,5	10	1	pce	POA
1146523	4501911026282	110mm	13	110	4	0,6	2	1	pce	POA
1146533	4501913526282	135mm	15.5	135	4	0,7	3	1	pce	POA
1161248	4501916026282	160mm	16	160	4	0,8	2	1	pce	POA

GF Silenta seal rubber trbg

- Rubber Seal for Silenta System

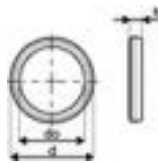

Item No.	Item no. GF	Dimensions	L mm	W mm	H mm	W kg	Pallet/ Pack	Box/M QTY	UOM	Price per m/each
1159807	1410905801192	58mm	69	69	10	0,005		1	pce	POA
1159813	1410907801192	78mm	89	89	10	0,007		1	pce	POA
1150064	1410909000192	90mm	101	101	10	0,015	13200	1	pce	POA
1150066	1410911000192	110mm	122	122	10	0,02	5418	1	pce	POA
1159825	1410913500192	135mm	150	150	12	0,024		1	pce	POA
1159827	1410916000192	160mm	177	177	13	0,036	1792	1	pce	POA
1159830	1410920000192	200mm	218	218	15	0,047	1080	1	pce	POA

GF Silenta clamp silence single

- For vertical and horizontal installation of Silenta 3A products



Item No.	Item no. GF	Dimensions	L mm	W mm	H mm	W kg	Pallet/ Pack	Box/M QTY	UOM	Price per m/each
1146151	1300905030612	50mm	60	60	30	0,167	150	1	pce	POA
1146160	1300912530612	125mm	135	135	40	0,287	25	1	pce	POA

Silenta

GF Silenta clamp silence single

- For vertical and horizontal installation of Silenta 3A/Silenta Premium products



Item No.	Item no. GF	Dimensions	L mm	W mm	H mm	W kg	Pallet/ Pack	Box/M QTY	UOM	Price per m/each
1146155	1300907530612	75-78mm	80	80	30	0,188	30	1	pce	POA
1146157	1300911030612	110mm	120	120	30	0,255	25	1	pce	POA
1146165	1300916030612	160mm	180	180	40	0,333	25	1	pce	POA
1146167	1300920030612	200mm	250	250	40	0,388	20	1	pce	POA

GF Silenta clamp silence single

- For vertical and horizontal installation of Silenta Premium products



Item No.	Item no. GF	Dimensions	L mm	W mm	H mm	W kg	Pallet/ Pack	Box/M QTY	UOM	Price per m/each
1146153	1300905830612	58mm	60	60	30	0,167	30	1	pce	POA
1146162	1300913530612	135mm	135	135	40	0,287	25	1	pce	POA

GF Silenta standard clamp

- Standard clamp for installation of HT-PP products

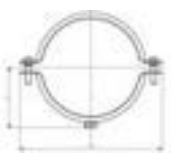

Item No.	Item no. GF	Dimensions	L mm	W mm	H mm	W kg	Pallet/ Pack	Box/M QTY	UOM	Price per m/each
1146635	4701905002022	50mm	55	55	30	0,082	100	1	pce	POA
1146505	4501905820082	58mm	60	60	30	0,096	100	1	pce	POA
1147141	4501757526682	75mm	80	80	50	0,195	40	1	pce	POA
1146511	4501907820182	78mm	80	80	30	0,135	75	1	pce	POA
1146522	4501911020282	110mm	125	125	40	0,235	40	1	pce	POA

GF Silenta Seal Rubber Double Lip

- Rubber Seal for Silenta System



Item No.	Item no. GF	Dimensions	L mm	W mm	H mm	W kg	Pallet/ Pack	Box/M QTY	UOM	Price per m/each
1162760	1410912501592	125mm	138	138	11	0,033		1	pce	POA
1162759	1410916002492	160mm	174.8	174.8	12.7	0,287		1	pce	POA

HT-PP



HT-PP pipes and fittings for waste-water applications are made of high-quality polypropylene ensuring lightweight construction, excellent chemical resistance, and superior abrasion resistance.

HT-PP provides the perfect solution where acoustic performance is not the primary consideration for the system.

The simple push-fit system, designed for gravity-fed domestic drainage, is manufactured to BS EN 1451 and is fast and economical to install.

Available in sizes DN 32 to DN 160, HT-PP offers a wide range of fittings and connections to allow complete design freedom.

Specification

- Manufactured using chemical and temperature resistant Polypropylene
- System according to the requirements of BS EN 1451
- Application area B to BS EN 1451
- Fire class E to BS EN 13501-1
- Pipe diameters from 32 mm to 160 mm
- Wide range of fittings to give complete design freedom
- For use with GF standard Clamp fittings

Benefits

- High temperature resistance for appliances such as washing machines and dishwashers.
- A lightweight, reliable alternative to uPVC and HDPE
- Free from halogens and does not release halogenic gases in event of fire
- 100% recyclable and environmentally friendly
- Corrosion-free and highly durable
- Easy push-fit installation

Application

- Office buildings and conference halls
- Schools, libraries, hospitals, hotels, and residential buildings
- Sustainable and green buildings
- Industrial facilities for both short- and long-term applications
- Ideal for pre-fabricated buildings

HT-PP

GF HT-PP Pipe with single socket S16

- Grey, monolayer, PP-material
- According to BS EN 1451

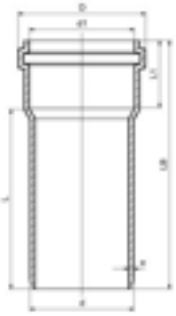

Item No.	Item no. GF	Dimensions	d/d1 mm	D mm	DN mm	e mm	L1 mm	L mm	LB mm	S	Pallet/ Pack	Box/M QTY	UOM	Price per m/
1150105	4801011025321	110x1000mm	110	129.3	110	3.4	65	1000	1065	16	4	1	pce	POA
1150106	4801011025421	110x2000mm	110	129.3	110	3.4	65	2000	2065	16	4	1	pce	POA

HT-PP

GF HT-PP pipe with single socket

- Where detailed Class is S20 to BS EN 1451
- Grey, monolayer, PP-material
- According to BS EN 1451

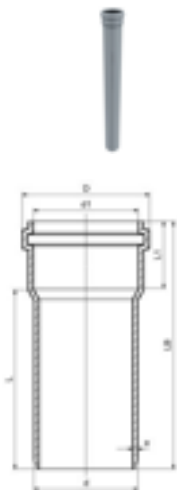

Item No.	Item no. GF	Dimensions	d/d1 mm	d1 mm	d mm	D mm	DN mm	e mm	L1 mm	L mm	LB mm	S	Pallet/ Pack	Box/M QTY	UOM	Price per m/
1150821	4801003200221	32x250mm	32	32,5	32	39	32	1,8	45	250	295	20	300	1	pce	POA
1150075	4801003200321	32x500mm	32	32,5	32	39	32	1,8	45	500	545	20	150	1	pce	POA
1150076	4801003200421	32x1000mm	32	32,5	32	39	32	1,8	45	1000	1045	20	10	1	pce	POA
1150822	4801003200621	32x2000mm	32	32,5	32	39	32	1,8	45	2000	2045	20	10	1	pce	POA
1150077	4801003200721	32x3000mm	32	32,5	32	39	32	1,8	45	3000	3045	20	10	1	pce	POA
1150078	4801004001221	40x500mm	40	40,5	40	50,3	40	1,8	45	500	545	20	140	1	pce	POA
1150823	4801004001321	40x1000mm	40	40,5	40	50,3	40	1,8	45	1000	1045	20	10	1	pce	POA
1150079	4801004001521	40x2000mm	40	40,5	40	50,3	40	1,8	45	2000	2045	20	10	1	pce	POA
1150080	4801004001621	40x3000mm	40	40,5	40	50,3	40	1,8	45	3000	3045	20	10	1	pce	POA
1150081	4801005002021	50x150mm	50	50,5	50	60	50	1,8	50	150	200	20	200	1	pce	POA
1150082	4801005002121	50x250mm	50	50,5	50	60	50	1,8	50	250	300	20	150	1	pce	POA
1150083	4801005002221	50x500mm	50	50,5	50	60	50	1,8	50	500	550	20	90	1	pce	POA
1150084	4801005002321	50x1000mm	50	50,5	50	60	50	1,8	50	1000	1050	20	10	1	pce	POA
1150086	4801005002521	50x2000mm	50	50,5	50	60	50	1,8	50	2000	2050	20	10	1	pce	POA
1150087	4801005002621	50x3000mm	50	50,5	50	60	50	1,8	50	3000	3050	20	10	1	pce	POA
1150091	4801007503021	75x150mm	75	75,6	75	85,2	75	1,9	55	150	205	20	100	1	pce	POA
1150092	4801007503121	75x250mm	75	75,6	75	85,2	75	1,9	55	250	305	20	70	1	pce	POA
1150093	4801007503221	75x500mm	75	75,6	75	85,2	75	1,9	55	500	555	20	40	1	pce	POA
1150094	4801007503321	75x1000mm	75	75,6	75	85,2	75	1,9	55	1000	1055	20	10	1	pce	POA
1150095	4801007503521	75x2000mm	75	75,6	75	85,2	75	1,9	55	2000	2055	20	10	1	pce	POA
1150096	4801007503621	75x3000mm	75	75,6	75	85,2	75	1,9	55	3000	3055	20	10	1	pce	POA
1150097	4801011004021	110x150mm	110	110,5	110	120,6	110	2,7	65	150	215	20	45	1	pce	POA
1150098	4801011004121	110x250mm	110	110,5	110	120,6	110	2,7	65	250	315	20	35	1	pce	POA
1150099	4801011004221	110x500mm	110	110,5	110	120,6	110	2,7	65	500	565	20	20	1	pce	POA
1150100	4801011004321	110x1000mm	110	110,5	110	120,6	110	2,7	65	1000	1065	20	4	1	pce	POA
1150102	4801011004521	110x2000mm	110	110,5	110	120,6	110	2,7	65	2000	2065	20	4	1	pce	POA
1150103	4801011004621	110x3000mm	110	110,5	110	120,6	110	2,7	65	3000	3065	20	4	1	pce	POA
1150107	4801012505021	125x150mm	125	125,5	125	136,9	125	3,1	65	150	215	20	40	1	pce	POA
1150108	4801012505121	125x250mm	125	125,5	125	136,9	125	3,1	65	250	315	20	20	1	pce	POA
1150109	4801012505221	125x500mm	125	125,5	125	136,9	125	3,1	65	500	565	20	16	1	pce	POA
1150110	4801012505321	125x1000mm	125	125,5	125	136,9	125	3,1	65	1000	1065	20	4	1	pce	POA
1150111	4801012505421	125x2000mm	125	125,5	125	136,9	125	3,1	65	2000	2065	20	4	1	pce	POA
1150112	4801012505521	125x3000mm	125	125,5	125	136,9	125	3,1	65	3000	3065	20	4	1	pce	POA
1150113	4801016006121	160x250mm	160	160,6	160	176,5	160	3,9	75	250	325	20	14	1	pce	POA
1150114	4801016006221	160x500mm	160	160,6	160	176,5	160	3,9	75	500	575	20	8	1	pce	POA
1150115	4801016006321	160x1000mm	160	160,6	160	176,5	160	3,9	75	1000	1075	20		1	pce	POA
1150116	4801016006421	160x2000mm	160	160,6	160	176,5	160	3,9	75	2000	2075	20		1	pce	POA
1150117	4801016006521	160x3000mm	160	160,6	160	176,5	160	3,9	75	3000	3075	20		1	pce	POA

HT-PP

GF HT-PP pipe with double socket S20

- Where detailed Class is S20 to BS EN 1451
- Grey, monolayer, PP-material
- According to BS EN 1451

Item No.	Item no. GF	Dimensions	b1 mm	b2 mm	d1 mm	d3 mm	d4 mm	d mm	D mm	e mm	L2 mm	L mm	LB mm	Pallet/ Pack	Box/M QTY	UOM	Price per m/
1150829	4801005020121	50x500mm	5	5	50,5	50,5	60	50	60	1,8	50	500	500	50	1	pce	POA
1150832	4801005020421	50x1000mm	5	5	50,5	50,5	60	50	60	1,8	50	1000	1000	10	1	pce	POA
1150830	4801005020221	50x2000mm	5	5	50,5	50,5	60	50	60	1,8	50	2000	2000	10	1	pce	POA
1150831	4801005020321	50x3000mm	5	5	50,5	50,5	60	50	60	1,8	50	3000	3000	10	1	pce	POA
1150838	4801007520621	75x3000mm	5	5	75,6	75,6	85,2	75	85,2	1,9	55	3000	3000	10	1	pce	POA
1150844	4801011020621	110x500mm	6	6	110,5	110,5	120,6	110	120,6	2,7	65	500	500	15	1	pce	POA
1150845	4801011020721	110x1000mm	6	6	110,5	110,5	120,6	110	120,6	2,7	65	1000	1000	4	1	pce	POA
1150846	4801011020821	110x2000mm	6	6	110,5	110,5	120,6	110	120,6	2,7	65	2000	2000	4	1	pce	POA
1150847	4801011020921	110x3000mm	6	6	110,5	110,5	120,6	110	120,6	2,7	65	3000	3000	4	1	pce	POA
1150854	4801012521321	125x3000mm	7	7	125,5	125,5	136,9	125	136,9	3,1	65	3000	3000	4	1	pce	POA

GF HT-PP elbow 15deg

- Grey, PP-material
- According to BS EN 1451



Item No.	Item no. GF	Dimensions	L mm	W mm	H mm	W kg	Pallet/ Pack	Box/M QTY	UOM	Price per m/each
1150121	4901103200121	32mm	45	45	90	0,015	1000	1	pce	POA
1150125	4901104001021	40mm	55	70	90	0,04	500	1	pce	POA
1150130	4901105002021	50mm	77	80	130	0,053	300	1	pce	POA
1150135	4901107503021	75mm	100	102	140	0,0925	150	1	pce	POA
1150140	4901111004021	110mm	135	138	161	0,22	60	1	pce	POA



HT-PP

GF HT-PP elbow 30deg

- Grey, PP-material
- According to BS EN 1451

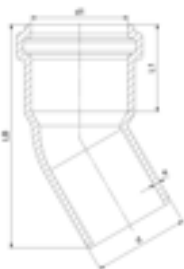

Item No.	Item no. GF	Dimensions	L mm	W mm	H mm	W kg	Pallet/ Pack	Box/M QTY	UOM	Price per m/each
1150122	4901103200221	32mm	45	60	90	0,02	1000	1	pce	POA
1150126	4901104001121	40mm	55	75	90	0,041	500	1	pce	POA
1150131	4901105002121	50mm	77	92	136	0,055	300	1	pce	POA
1150136	4901107503121	75mm	100	115	152	0,11	150	1	pce	POA
1150141	4901111004121	110mm	135	150	177	0,3	60	1	pce	POA
1150882	4901116005621	160mm	188	214	241	0,87	20	1	pce	POA

GF HT-PP elbow 45deg

- Grey, PP-material
- According to BS EN 1451

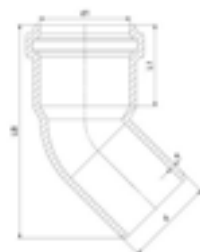

Item No.	Item no. GF	Dimensions	L mm	W mm	H mm	W kg	Pallet/ Pack	Box/M QTY	UOM	Price per m/each
1150123	4901103200321	32mm	45	90	85	0,03	1000	1	pce	POA
1150127	4901104001221	40mm	55	95	85	0,046	500	1	pce	POA
1150132	4901105002221	50mm	77	105	140	0,076	300	1	pce	POA
1150137	4901107503221	75mm	100	125	155	0,118	150	1	pce	POA
1150142	4901111004221	110mm	135	165	192	0,37	50	1	pce	POA
1150145	4901112505021	125mm	150	196	218	0,5	40	1	pce	POA
1150147	4901116006021	160mm	188	235	265	0,715	20	1	pce	POA

GF HT-PP elbow 67,5deg

- Grey, PP-material
- According to BS EN 1451

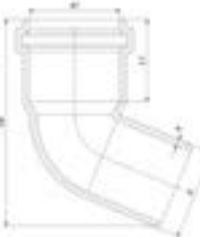

Item No.	Item no. GF	Dimensions	L mm	W mm	H mm	W kg	Pallet/ Pack	Box/M QTY	UOM	Price per m/each
1150129	4901104001421	40mm	55	100	70	0,046	500	1	pce	POA
1150133	4901105002321	50mm	77	115	135	0,067	300	1	pce	POA
1150138	4901107503321	75mm	100	140	156	0,135	150	1	pce	POA
1150143	4901111004321	110mm	135	177	195	0,33	50	1	pce	POA

HT-PP

GF HT-PP elbow 87,5deg

- Grey, PP-material
- According to BS EN 1451

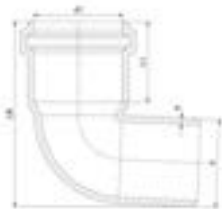

Item No.	Item no. GF	Dimensions	L mm	W mm	H mm	W kg	Pallet/ Pack	Box/M QTY	UOM	Price per m/each
1150124	4901103200421	32mm	45	110	80	0,03	1000	1	pce	POA
1150128	4901104001321	40mm	55	120	80	0,046	500	1	pce	POA
1150134	4901105002421	50mm	77	120	125	0,073	300	1	pce	POA
1150139	4901107503421	75mm	100	133	145	0,165	100	1	pce	POA
1150144	4901111004421	110mm	135	177	185	0,466	40	1	pce	POA
1150146	4901112505121	125mm	150	210	210	0,438	30	1	pce	POA
1150148	4901116006121	160mm	188	265	254	1,005	15	1	pce	POA

GF HT-PP branch 45deg

- Grey, PP-material
- According to BS EN 1451



Item No.	Item no. GF	Dimensions	L mm	W mm	H mm	W kg	Pallet/ Pack	Box/M QTY	UOM	Price per m/each
1150149	4901203200121	32-32mm	45	95	135	0,0365	500	1	pce	POA
1150151	4901204001021	40-40mm	55	110	120	0,064	250	1	pce	POA
1150156	4901205042721	50-32mm	65	110	175	0,058	250	1	pce	POA
1162600	4901205041121	50-40mm	63.5	123.5	157.5	0,066	200	1	pce	POA
1150153	4901205002021	50-50mm	65	130	175	0,104	150	1	pce	POA
1150157	4901207503021	75-50mm	90	154	180	0,175	75	1	pce	POA
1150158	4901207503121	75-75mm	90	180	215	0,345	60	1	pce	POA
1150162	4901211004021	110-50mm	130	190	202	0,41	40	1	pce	POA
1150163	4901211004121	110-75mm	130	215	240	0,515	30	1	pce	POA
1150164	4901211004221	110-110mm	130	250	290	0,751	20	1	pce	POA
1162601	4901212505021	125-50mm	145.4	206.9	210	0,284	30	1	pce	POA
1150175	4901212505121	125-75mm	145	232	290	0,605	24	1	pce	POA
1150176	4901212505221	125-110mm	145	262	300	1,075	15	1	pce	POA
1150177	4901212505321	125-125mm	145	280	320	0,699	16	1	pce	POA
1150179	4901216006021	160-110mm	185	428	320	1,35	10	1	pce	POA
1150180	4901216006121	160-125mm	185	315	380	0,892	10	1	pce	POA
1150181	4901216006221	160-160mm	185	350	400	1,572	8	1	pce	POA

HT-PP

GF HT-PP branch 67,5deg

- Grey, PP-material
- According to BS EN 1451



Item No.	Item no. GF	Dimensions	b1 mm	d/d1 mm	d1 mm	d2 mm	d3 mm	d4 mm	d mm	DN mm	e mm	L1 mm	L2 mm	L mm	LB mm	S	SP	z1 mm	z2 mm	Pallet/ Pack	Box/M QTY	Price UOMper m/each	
1150173	4901211041221	110-110mm	6	110	110,5	121,2	110,5	121,2	110	110-110	3,4	74	74	58	132	16	25	119	46	25	1	pce	POA

GF HT-PP branch 87,5deg

- Grey, PP-material
- According to BS EN 1451

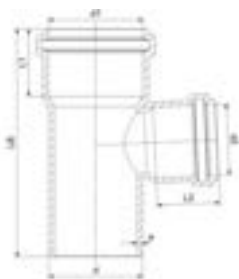

Item No.	Item no. GF	Dimensions	L mm	W mm	H mm	W kg	Pallet/ Pack	Box/M QTY	UOM	Price per m/each
1150150	4901203241321	32-32mm	45	100	135	0,025	500	1	pce	POA
1150152	4901204042821	40-40mm	55	140	120	0,043	200	1	pce	POA
1162602	4901205042921	50-40mm	63.8	110	143.2	0,0625	200	1	pce	POA
1150154	4901205007021	50-50mm	65	110	155	0,125	150	1	pce	POA
1150159	4901207508021	75-50mm	90	135	180	0,218	100	1	pce	POA
1150160	4901207508121	75-75mm	90	145	216	0,15	80	1	pce	POA
1150165	4901211009021	110-50mm	130	170	183	0,284	50	1	pce	POA
1150167	4901211009221	110-110mm	130	190	245	0,587	30	1	pce	POA
1150166	4901211009121	110-75mm	130	182	245	0,55	30	1	pce	POA
1150178	4901212510321	125-125mm	145	216	280	0,735	20	1	pce	POA
1150918	4901216010921	160-110mm	185	250	325	0,94	14	1	pce	POA
1150919	4901216011121	160-160mm	185	263	325	1,642	10	1	pce	POA

HT-PP

GF HT-PP double branch 45deg

- Grey, PP-material
- According to BS EN 1451

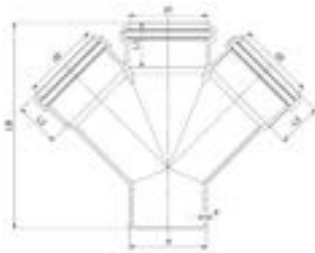

Item No.	Item no. GF	Dimensions	b1 mm	b2 mm	d/d1 mm	d1 mm	d2 mm	d3 mm	d4 mm	d5 mm	d6 mm	d mm	DN mm	e mm	L1 mm	L2 mm	L mm	LB mm	S	z1 mm	z2 mm	Pack QTY	Price per m/each
1150155	4901205012021	50-50mm	5	5	50	50,5	59,6	50,5	59,6	50,5	59,6	50	50-50	1,8	48,9	48,9	46	94,9	16	71,2	50,	20	POA
1150161	4901207513021	75-50mm	5	5	75	75,5	84,6	50,5	59,6	50,5	59,6	75	75-50	2,3	57,9	48,9	51	108,9	16	71,4	50,	20	POA
1150174	4901211042621	110-50mm	5	5	110	110,5	121,2	50,5	59,6	50,5	59,6	110	110-50	3,4	64,9	48,9	58	122,9	16	71,6	50,	20	POA
1150168	4901211014021	110-110mm	6	6	110	110,5	121,2	110,5	121,2	110,5	121,2	110	110-110	3,4	64,4	64,4	58	122,4	16	156,5	111,	20	POA
1150920	4901216042021	160-110mm	6	6		160,6	175,2	110,5	121,2	110,5	121,2	160		4,9	80,5	64,4	73	153,5		156,6	111,	20	POA

GF HT-PP double branch 87,5deg

- Grey, PP-material
- According to BS EN 1451

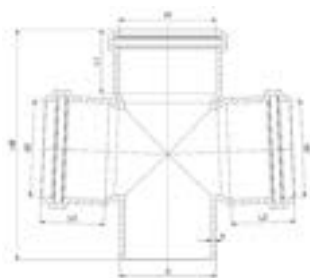

Item No.	Item no. GF	Dimensions	L mm	W mm	H mm	W kg	Pallet/ Pack	Box/M QTY	UOM	Price per m/each
1150169	4901211014121	110-110mm	130	268	241	0,811	20	1	pce	POA

HT-PP

GF HT-PP double branch radius 87,5deg

- Grey, PP-material
- According to BS EN 1451

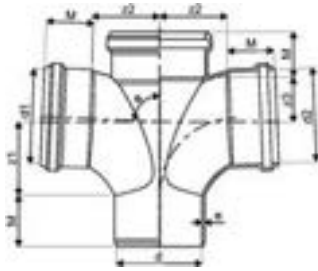

Item No.	Item no. GF	In/Out	Dimensions	L mm	W mm	H mm	W kg	Pallet/ Pack	Box/M QTY	UOM	Price per m/each
1185521	4901211031221	03.26	110-110mm	256	128	292	0,514	4	1	pce	POA

GF HT-PP corner double branch 87,5deg

- Grey, PP-material
- According to BS EN 1451

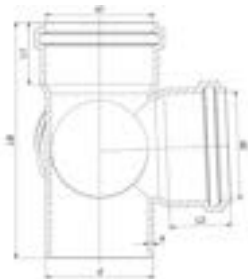

Item No.	Item no. GF	Dimensions	L mm	W mm	H mm	W kg	Pallet/ Pack	Box/M QTY	UOM	Price per m/each
1150172	4901211015521	110-110mm	201	201	241	0,99	20	1	pce	POA

GF HT-PP reducer eccentric

- Grey, PP-material
- According to BS EN 1451

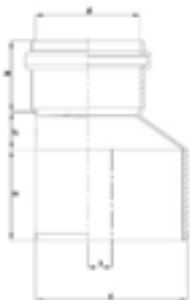

Item No.	Item no. GF	Dimensions	L mm	W mm	H mm	W kg	Pallet/ Pack	Box/M QTY	UOM	Price per m/each
1150925	4901404017021	40-32mm	43	43	100	0,035	750	1	pce	POA
1150184	4901405016521	50-32mm	55	55	111	0,03	500	1	pce	POA
1150185	4901405017021	50-40mm	58	58	116	0,046	500	1	pce	POA
1150186	4901407517121	75-50mm	82	82	125	0,076	200	1	pce	POA
1150187	4901411017221	110-50mm	120	120	155	0,276	100	1	pce	POA
1150188	4901411017321	110-75mm	120	120	143	0,21	100	1	pce	POA
1150189	4901412517421	125-110mm	135	135	145	0,36	50	1	pce	POA
1150190	4901416017521	160-110mm	170	170	180	0,623	40	1	pce	POA
1150191	4901416041021	160-125mm	170	170	182	0,42	50	1	pce	POA

HT-PP

GF HT-PP socket

- Grey, PP-material
- According to BS EN 1451

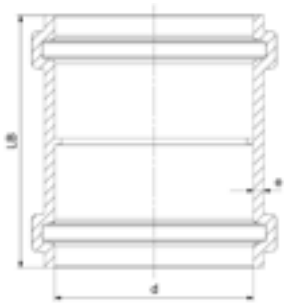

Item No.	Item no. GF	Dimensions	d1 mm	d2 mm	d mm	DN mm	e mm	L1 mm	LB mm	S mm	z1 mm	Pallet/ Pack	Box/M QTY	UOM	Price per m/
1150192	4901503241421	32mm	32,5	39,8	32	32	1,8	46	46	16	2,2	600	1	pce	POA
1150193	4901504041521	40mm	40,5	49,6	40	40	1,8	46	46	16	2,2	500	1	pce	POA
1150194	4901505031621	50mm	50,5	59,6	50	50	1,8	44	44	16	3	400	1	pce	POA
1150196	4901507531721	75mm	75,5	84,6	75	75	2,3	49	49	16	3	200	1	pce	POA
1150199	4901511031821	110mm	110,5	121,2	110	110	5,3	51	51	16	3	80	1	pce	POA
1150201	4901516031921	160mm	160,6	175,2	160	160	5,3	70	70	16	3	30	1	pce	POA

GF HT-PP sleeve socket

- Grey, PP-material
- According to BS EN 1451

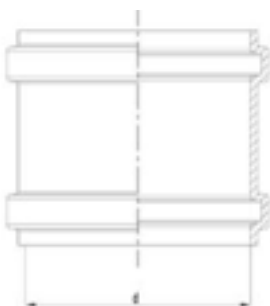

Item No.	Item no. GF	Dimensions	L mm	W mm	H mm	W kg	Pallet/ Pack	Box/M QTY	UOM	Price per m/each
1150939	4901503241521	32mm	38	38	90	0,0265	600	1	pce	POA
1150195	4901505031721	50mm	64	64	92	0,0649	400	1	pce	POA
1150197	4901507531821	75mm	90	90	100	0,061	200	1	pce	POA
1150200	4901511040621	110mm	135	135	120	0,33	80	1	pce	POA
1150202	4901516032021	160mm	188	188	140	0,508	30	1	pce	POA

HT-PP

GF HT-PP socket plug

- Grey, PP-material
- According to BS EN 1451

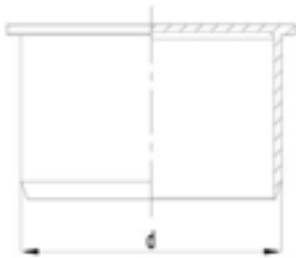

Item No.	Item no. GF	Dimensions	L mm	W mm	H mm	W kg	Pallet/ Pack	Box/M QTY	UOM	Price per m/each
1150953	4901903241621	32mm	39	39	43	0,01736	1250	1	pce	POA
1150205	4901904041721	40mm	48	48	45	0,02206	1000	1	pce	POA
1150206	4901905040721	50mm	60	60	48	0,026	1000	1	pce	POA
1150207	4901907540821	75mm	85	85	50	0,059	200	1	pce	POA
1150209	4901911016021	110mm	120	120	55	0,096	200	1	pce	POA
1150212	4901916016121	160mm	173	173	88	0,37	60	1	pce	POA

GF HT-PP S-siphon 45deg

- Grey, PP-material
- According to BS EN 1451

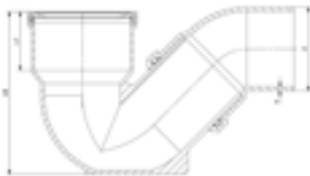

Item No.	Item no. GF	Dimensions	L mm	W mm	H mm	W kg	Pallet/ Pack	Box/M QTY	UOM	Price per m/each
1150198	4901507592421	75mm	130	300	200	0,353	50	1	pce	POA
1150203	4901611015021	110mm	144	350	215	1,22	20	1	pce	POA

GF HT-PP S-siphon 87,5deg

- Grey, PP-material
- According to BS EN 1451



Item No.	Item no. GF	Dimensions	L mm	W mm	H mm	W kg	Pallet/ Pack	Box/M QTY	UOM	Price per m/each
1150204	4901611015121	110mm	144	404	215	1,3	15	1	pce	POA

HT-PP

GF HT-PP access pipe circular

- Gray, PP-material, according to EN 1451



Item No.	Item no. GF	Dimensions	L mm	W mm	H mm	W kg	Pallet/ Pack	Box/M QTY	UOM	Price per m/each
1150182	4901307530921	75mm	100	115	240	0,295	64	1	pce	POA
1150183	4901311031321	110mm	155	155	350	0,597	30	1	pce	POA

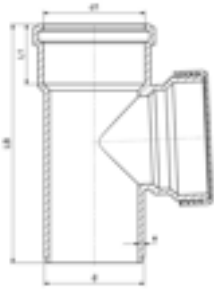

GF HT-PP access pipe rectangular

- Grey, PP-material
- According to BS EN 1451



Item No.	Item no. GF	Dimensions	L mm	W mm	H mm	W kg	Pallet/ Pack	Box/M QTY	UOM	Price per m/each
1150213	4901916041821	160mm	210	210	413	3,35	8	1	pce	POA

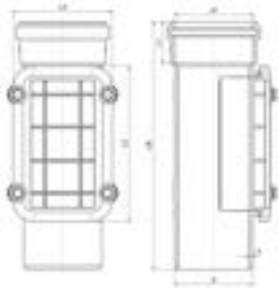

HT-PP

GF Silenta HT-PP white pipe with single socket S16/S20

- White, monolayer, PP-material
- According to BS EN 1451

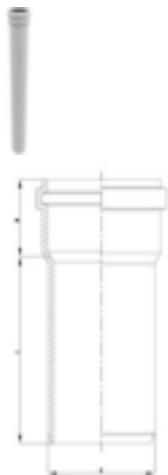

Item No.	Item no. GF	In/Out	Dimensions	d mm	M mm	Pallet/ Pack	Box/M QTY	UOM	Price per m/each
1184620	4800003200221	03.26	32x250mm	32	45		300	pce	POA
1184621	4800003200321	03.26	32x500mm	32	45		150	pce	POA
1184622	4800003200421	03.26	32x1000mm	32	45		10	pce	POA
1184623	4800003200521	03.26	32x2000mm	32	45		10	pce	POA
1184624	4800004000321	03.26	40x500mm	40	45		140	pce	POA
1184625	4800004000421	03.26	40x1000mm	40	45		10	pce	POA
1184626	4800005000221	03.26	50x250mm	50	50		150	pce	POA
1184627	4800005000321	03.26	50x500mm	50	50		90	pce	POA
1184628	4800005000421	03.26	50x1000mm	50	50		10	pce	POA

GF HT-PP white branch 45deg

- White, PP-material
- According to BS EN 1451



Item No.	Item no. GF	In/Out	Dimensions	l1 mm	α Degree	d mm	d1 mm	M mm	M1 mm	z1 mm	z2 mm	z3 mm	Pallet/ Pack	Box/M QTY	UOM	Price per m/
1184643	4900203200121	03.26	32-32mm	42,1	45°	32	32,5	41,8	41,8	5,8	36,9	42,7		500	pce	POA
1184644	4900204000121	03.26	40-40mm	42,4	45°	40	40,5	56,7	56,6	7,6	44,1	52,8		250	pce	POA
1184645	4900205000121	03.26	50-50mm	55,7	45°	50	50,5	48,9	48,9	9,5	50	60,9		150	pce	POA

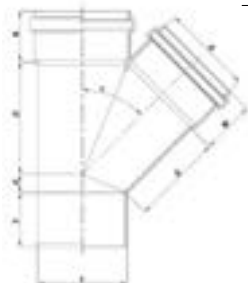

HT-PP

GF HT-PP white branch 87,5deg

- White, PP-material
- According to BS EN 1451



Item No.	Item no. GF	In/Out	Dimensions	l1 mm	α Degree	d mm	d1 mm	M mm	M1 mm	z1 mm	z2 mm	z3 mm	Pallet/ Pack	Box/M QTY	UOM	Price per m/
1184646	4900203200221	03.26	32-32mm	46	87,5°	32	32,5	41,8	41,8	13,5	8,8	22,3		500	pce	POA
1184647	4900204000221	03.26	40-40mm	52	87,5°	40	40,5	50,6	50,6	17,1	7,4	24,5		200	pce	POA
1184648	4900205000221	03.26	50-50mm	57,4	87,5°	50	50,5	49,4	48,9	22	2,2	26,1		150	pce	POA

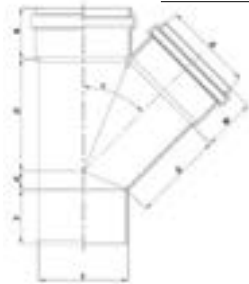

GF HT-PP white elbow 15deg

- White, PP-material
- According to BS EN 1451



Item No.	Item no. GF	In/Out	Dimensions	do mm	α Degree	d mm	d1 mm	d2 mm	e mm	f mm	M mm	z1 mm	z2 mm	l1 mm	Pallet/ Pack	Box/M QTY	UOM	Price per m/
1184633	4900103200121	03.26	32mm	16	15	32	16,2	19,9	1,8	4,6	41,6	2,1	4,6	43		1000	pce	POA



HT-PP

GF HT-PP white elbow 30deg

- White, PP-material
- According to BS EN 1451



Item No.	Item no. GF	In/Out	Dimensions	do mm	α Degree	d mm	d1 mm	d2 mm	e mm	f mm	M mm	z1 mm	z2 mm	l1 mm	Pallet/ Pack	Box/M QTY	UOM	Price per m/
1184634	4900103200221	03.26	32mm	16	30	32	16,2	19,9	1,8	4,6	41,6	4,3	7,4	43		1000	pce	POA
1184635	4900104000221	03.26	40mm	20	30	40	20,2	24,8	1,8	9,87	50,2	5,4	8,1	45		500	pce	POA
1184636	4900105000221	03.26	50mm	25	30	50	25,25	29,95	2	8	47,2	6,7	8,9	50		300	pce	POA

GF HT-PP white elbow 45deg

- White, PP-material
- According to BS EN 1451



Item No.	Item no. GF	In/Out	Dimensions	l1 mm	do mm	α Degree	d mm	d1 mm	d2 mm	e mm	f mm	M mm	z1 mm	z2 mm	l1 mm	Pallet/ Pack	Box/M QTY	UOM	Price per m/
1184637	4900103200321	03.26	32mm		32	45	32	16,2	19,9	1,8	4,6	41,6	6,6	9,7	43		1000	pce	POA
1184638	4900104000321	03.26	40mm		20	45	40	20,2	24,8	1,8	9,87	50,2	8,3	11	45		500	pce	POA
1184639	4900105000321	03.26	50mm	50		45	50					49,4	10,4	10,4			300	pce	POA

HT-PP

GF HT-PP white elbow 87,5deg

- White, PP-material
- According to BS EN 1451



Item No.	Item no. GF	In/Out	Dimensions	l1 mm	α Degree	d mm	M mm	z1 mm	z2 mm	Pallet/ Pack	Box/M QTY	UOM	Price per m/each
1184640	4900103200421	03.26	32mm	43	87,5	32	41,6	15,2	18,3		1000	pce	POA
1184641	4900104000421	03.26	40mm	45	87,5	40	50,2	19	21,7		500	pce	POA
1184642	4900105000421	03.26	50mm	50	87,5	50	49,4	23,9	23,9		300	pce	POA

GF HT-PP white socket

- White, PP-material
- According to BS EN 1451

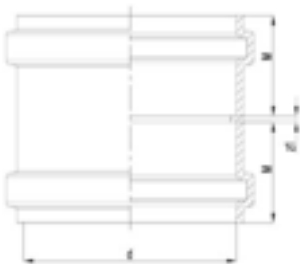

Item No.	Item no. GF	In/Out	Dimensions	d mm	M mm	z1 mm	Pallet/ Pack	Box/M QTY	UOM	Price per m/each
1184629	4900503200121	03.26	32mm	32,4	42,6	3		600	pce	POA
1184630	4900504000121	03.26	40mm	40,4	45,1	3		500	pce	POA
1184631	4900505000121	03.26	50mm	50,5	43,5	3		400	pce	POA

HT-PP

GF HT-PP white sleeve socket

- White, PP-material
- According to BS EN 1451

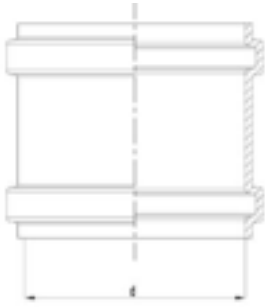

Item No.	Item no. GF	In/Out	Dimensions	d mm	Pallet/ Pack	Box/M QTY	UOM	Price per m/each
1184632	4900503200221	03.26	32mm	32,4		600	pce	POA

HypAir



Uponor HypAir admittance valves support proper ventilation of drainage systems in both domestic and commercial installations.

Uponor HypAir is a high performance, one-way mechanical ventilation valve which maintains hygiene whilst preventing negative pressures from draining water seals from traps and syphons.

Specification

- Compliant with Building Regulations - Approved Document H
- Certified classification A1 acc BS EN 12380: operation at temperatures -20°C - +60°C
- Approved for use below the flood level of connected appliances
- Two sizes for universal installation 32-63mm or 70-110mm
- Suitable for use in all appropriate sized drainage systems - PP, PVC, Cast Iron and HDPE

Benefits

- Universal portfolio
- 2 items to cover pipe dimensions 32 – 110mm.
- Certified classification A1 acc BS EN 12380: operation at temperatures -20°C - +60°C
- Approved for location below the flood level of connected appliances.
- Minimizes the need of high cost above roof ventilation
- Enables longer distance between fixtures and risers
- Allows design freedom.
- Maintenance-free

Application

- Housing sewage system ventilation acc. to Approved Document H

Certification

- Class A1 acc EN 12380
- TÜV certified.

HypAir

Uponor HypAir admittance valve

- Air admittance valve for sewage systems
- 2 sizes cover all pipe sizes from 32-110mm
- Fast, reliable installation
- Compatible with a wide range of pipe materials

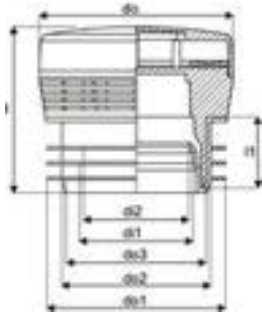

Item No.	Dimensions	di1 mm	di2 mm	l1 mm	l mm	do mm	do1 mm	do2 mm	do3 mm	Pallet/ Pack	Box/M QTY	UOM	Price per m/each
1134571	70-110	75	70	46	108	125	110	100	90	27	1	pce	24,27
1134572	32-63	40	32	35	80	70	63	-	50	100	1	pce	15,80

Aqua Ambient



Benefits

- Modern construction and stylish design
- Suitable for every kind of floor construction
- Easy installation
- High performance material and robust construction

Aqua Ambient shower and bathroom waste inlets, feature a versatile range of modern, stylish fixtures. Manufactured according to the highest standards and finished with an elegant stainless-steel grate, Aqua Ambient ranges are the perfect accompaniment for most modern bathrooms.

Specification

- Available in different sizes: 600, 700, 800, 900, 1000mm
- Wide sealing collar (30mm) ensuring tight jointing to the floor construction
- Adjustable height and fixable legs for integration in every kind of floor construction
- Wide range compatible with all common waste outlet pipe-work.

Uponor Aqua Ambient shower inlet silver

- Compatible with various grate attachments
- Flow rate: 0,8 l/s
- Siphon with cleaning basket, connection to waste pipes DN 50
- Material body: stainless steel
- Material siphon: polypropylene / ABS

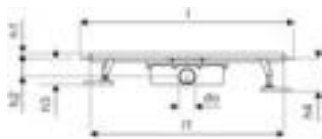

Application

- Bathroom greywater applications

Certification

- Technical assessment acc BS EN 1253

Item No.	Dimensions	l1 mm	l mm	do mm	h mm	h1 mm	h2 mm	w mm	w1 mm	z1 mm	Pallet/ Pack	Box/M QTY	UOM	Price per m/each
1136397	30/600mm	598	660	40	98	82	40	303	143	45	80	1	pce	119,79
1136399	30/800mm	798	860	40	98	82	40	303	143	45	50	1	pce	233,80
1136398	30/700mm	698	760	40	98	82	40	303	143	45	70	1	pce	119,79
1136401	30/1000mm	998	1060	40	98	82	40	303	143	45	50	1	pce	238,16
1136400	30/900mm	898	960	40	98	82	40	303	143	45	50	1	pce	228,18

Aqua Ambient

Uponor Aqua Ambient shower inlet black

- Compatible with various grate attachments
- Flow rate: 0,8 l/s
- Siphon with cleaning basket, connection to waste pipes DN 50
- Material body: stainless steel matt black powder-coated
- Material siphon: polypropylene / ABS

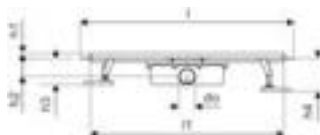

Item No.	Dimensions	l1 mm	l mm	do mm	h mm	h1 mm	h2 mm	w mm	Pallet/ Pack	Box/M QTY	UOM	Price per m/each
1136402	30/600mm	597,5	660	50	113	97	55	142,5	80	1	pce	119,79
1136403	30/700mm	697,5	760	50	113	97	55	142,5	70	1	pce	119,79
1136404	30/800mm	797,5	860	50	113	97	55	142,5	50	1	pce	214,74
1136405	30/900mm	897,5	960	50	113	97	55	142,5	50	1	pce	78,89
1136406	30/1000mm	997,5	1060	50	113	97	55	142,5	50	1	pce	214,30

Uponor Aqua Ambient shower inlet low silver

- Compatible with various grates (see separate items)
- For low floor construction
- Flow rate: 0,6 l/s
- Siphon with cleaning basket, connection to waste pipes DN 40, with horizontal 360° alignment
- Material body: stainless-steel
- Material siphon: polypropylene / ABS

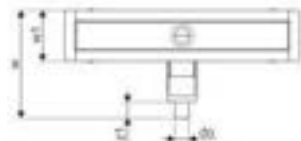

Item No.	Dimensions	l1 mm	l mm	do mm	h mm	h1 mm	h2 mm	w mm	w1 mm	z1 mm	Pallet/ Pack	Box/M QTY	UOM	Price per m/each
1136407	30/600mm	600	660	40	98	82	40	303	143	45	80	1	pce	192,25
1136410	30/900mm	900	960	40	98	82	40	303	143	45	50	1	pce	219,89
1136409	30/800mm	800	860	40	98	82	40	303	143	45	50	1	pce	211,05
1136408	30/700mm	700	760	40	98	82	40	303	143	45	70	1	pce	204,32
1136411	30/1000mm	1000	1060	40	98	82	40	303	143	45	50	1	pce	226,28

Aqua Ambient

Uponor Aqua Ambient shower inlet low black

- Compatible with various grate attachments
- For low floor construction
- Flow rate: 0,6 l/s
- Siphon with cleaning basket, connection to waste pipes DN 40, with horizontal 360° alignment
- Material body: matt black powder-coated stainless-steel
- Material siphon: polypropylene / ABS

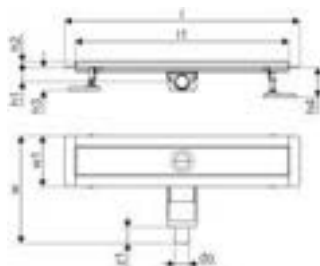

Item No.	Dimensions	l1 mm	l mm	do mm	h mm	h1 mm	h2 mm	w mm	w1 mm	z1 mm	Pallet/ Pack	Box/M QTY	UOM	Price per m/each
1136414	30/800mm	800	860	40	98	82	40	303	143	45	50	1	pce	192,56
1136415	30/900mm	900	960	40	98	82	40	303	143	45	50	1	pce	198,12
1136416	30/1000mm	1000	1060	40	98	82	40	303	143	45	50	1	pce	205,43
1136412	30/600mm	600	660	40	98	82	40	303	143	45	80	1	pce	174,60
1136413	30/700mm	700	760	40	98	82	40	303	143	45	70	1	pce	184,50

Uponor Aqua Ambient shower inlet grate spot / silver

- Grate design: spot
- Compatible to shower inlets "silver"
- Material: polished stainless steel



Item No.	Dimensions	l mm	h mm	w mm	Pallet/ Pack	Box/M QTY	UOM	Price per m/each
1136419	800mm	788	26,8	71,5	363	1	pce	63,33
1136417	600mm	588	26,8	71,5	429	1	pce	52,22
1136420	900mm	888	26,8	71,5	231	1	pce	66,60
1136421	1000mm	988	26,8	71,5	210	1	pce	70,03
1136418	700mm	688	26,8	71,5	363	1	pce	57,66

Uponor Aqua Ambient shower inlet grate spot / black

- Grate design: spot
- Compatible to shower inlets "black"
- Material: matt black powder-coated stainless-steel



Item No.	Dimensions	l mm	h mm	w mm	Pallet/ Pack	Box/M QTY	UOM	Price per m/each
1136425	900mm	888	26,8	71,5	231	1	pce	68,66
1136426	1000mm	988	26,8	71,5	231	1	pce	72,44
1136424	800mm	788	26,8	71,5	363	1	pce	64,97
1136422	600mm	588	26,8	71,5	429	1	pce	54,14
1136423	700mm	688	26,8	71,5	275	1	pce	58,41

Aqua Ambient

Uponor Aqua Ambient shower inlet grate plain / silver

- Grate design: plain
- Compatible to shower inlets "silver"
- Material: polished stainless steel



Item No.	Dimensions	l mm	h mm	w mm	Pallet/ Pack	Box/M QTY	UOM	Price per m/each
1136429	800mm	788	26,8	71,5	275	1	pce	39,16
1136427	600mm	588	26,8	71,5	390	1	pce	36,08
1136428	700mm	688	26,8	71,5	363	1	pce	36,54
1136430	900mm	888	26,8	71,5	175	1	pce	40,55
1136431	1000mm	988	26,8	71,5	175	1	pce	40,07

Uponor Aqua Ambient shower inlet grate stone / silver

- Grate design: stone
- Compatible to shower inlets "silver"
- Material: polished stainless-steel

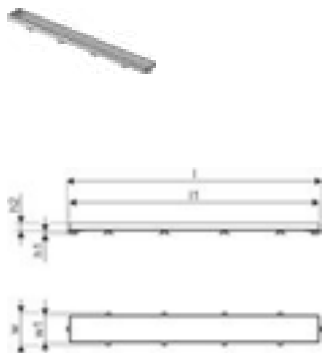

Item No.	Dimensions	l1 mm	l mm	h1 mm	h2 mm	w mm	w1 mm	Pallet/ Pack	Box/M QTY	UOM	Price per m/each
1136441	1000mm	981	993	6,8	19	76,5	63,5	231	1	pce	67,32
1136438	700mm			6,8	19	76,5	63,5	363	1	pce	24,20
1136437	600mm	581	593	6,8	19	76,5	63,5	429	1	pce	24,20
1136439	800mm			6,8	19	76,5	63,5	363	1	pce	63,91
1136440	900mm			6,8	19	76,5	63,5	231	1	pce	70,27

Uponor Aqua Ambient shower inlet grate stone / black

- Grate design: stone
- Compatible to shower inlets "black"
- Material: matt black powder-coated stainless-steel

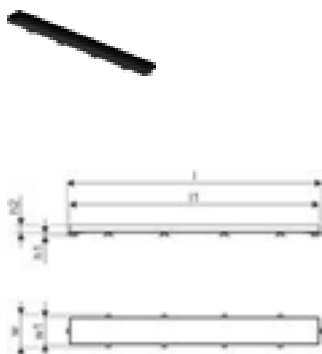

Item No.	Dimensions	l1 mm	l mm	h1 mm	h2 mm	w mm	w1 mm	Pallet/ Pack	Box/M QTY	UOM	Price per m/each
1136445	900mm	881	893	6,8	19	76,5	63,5	231	1	pce	18,59
1136443	700mm	681	693	6,8	19	76,5	63,5	275	1	pce	24,20
1136446	1000mm	981	993	6,8	19	76,5	63,5	231	1	pce	51,42
1136444	800mm	781	793	6,8	19	76,5	63,5	363	1	pce	49,90
1136442	600mm	581	593	6,8	19	76,5	63,5	325	1	pce	24,20

Aqua Ambient

Uponor Aqua Ambient point drain inlet elb. classic/arco

- Connection to waste pipes DN 50
- Flow rate: 0,8 l/s
- Material grate: stainless steel
- Material body: polypropylene

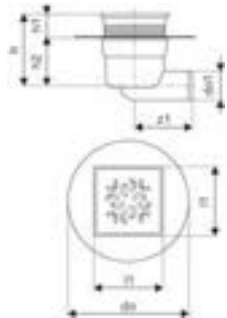

Item No.	Dimensions	l1 mm	do mm	do1 mm	h mm	h1 mm	h2 mm	z1 mm	Pallet/ Pack	Box/M QTY	UOM	Price per m/each
1136447	FI 50	120	210	50	124,3	40,9	83,4	100	180	1	pce	31,54

Uponor Aqua Ambient point drain inlet elb. classic/spot

- Connection to waste pipes DN 50
- Flow rate: 0,8 l/s
- Material grate: stainless-steel
- Material body: polypropylene



Item No.	Dimensions	l1 mm	do mm	do1 mm	h mm	h1 mm	h2 mm	z1 mm	Pallet/ Pack	Box/M QTY	UOM	Price per m/each
1136448	FI 50	120	210	50	124,3	83,4	40,9	100	180	1	pce	31,97

Aqua Ambient

Uponor Aqua Ambient point drain inlet elb. classic/cube

- Connection to waste pipes DN 50
- Flow rate: 0,8 l/s
- Material grate: stainless-steel
- Material body: polypropylene

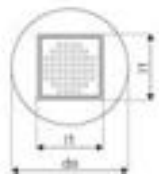
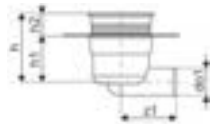

Item No.	Dimensions	l1 mm	do mm	do1 mm	h mm	h1 mm	h2 mm	z1 mm	Pallet/ Pack	Box/M QTY	UOM	Price per m/each
1136449	FI 50	120	210	50	123,4	83,4	38,4	100	180	1	pce	12,58

Uponor Aqua Ambient point drain inlet elb. super/arco

- Connection to waste pipes DN 50
- Flow rate: 0,4 l/s
- For low floor constructions
- Material grate: stainless-steel
- Material body: polypropylene

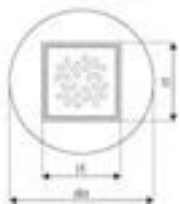
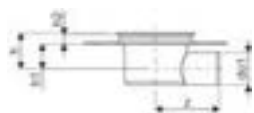

Item No.	Dimensions	l1 mm	do mm	do1 mm	z mm	h mm	h1 mm	h2 mm	Pallet/ Pack	Box/M QTY	UOM	Price per m/each
1136450	FI 50	120	220	50	98	55	38	14,5	300	1	pce	34,07

Aqua Ambient

Uponor Aqua Ambient point drain inlet elb. super/spot

- Connection to waste pipes DN 50
- Flow rate: 0,4 l/s
- For low floor constructions
- Material grate: stainless-steel
- Material body: polypropylene



Item No.	Dimensions	l1 mm	do mm	do1 mm	z mm	h mm	h1 mm	h2 mm	Pallet/ Pack	Box/M QTY	UOM	Price per m/each
1136452	FI 50	120	220	50	98	55	38	14,5	300	1	pce	36,52

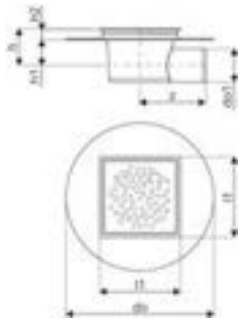

Uponor Aqua Ambient point drain inlet elb. super/cube

- Connection to waste pipes DN 50
- Flow rate: 0,4 l/s
- For low floor constructions
- Material grate: stainless-steel
- Material body: polypropylene



Item No.	Dimensions	l1 mm	do mm	do1 mm	z mm	h mm	h1 mm	h2 mm	Pallet/ Pack	Box/M QTY	UOM	Price per m/each
1136453	FI 50	120	220	50	98	55	38	14,5	225	1	pce	34,53

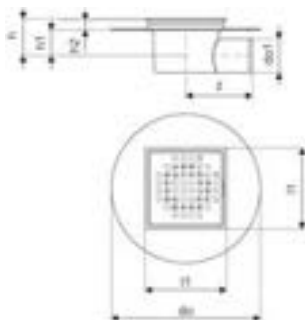

Aqua Ambient

Uponor Aqua Ambient point drain inlet elb. standard

- Connection to waste pipes DN 50 or DN 110
- Flow rate: DN 50 0,8 l/s, DN 110 1,4 l/s
- Material grate: stainless-steel
- Material body: Polypropylene

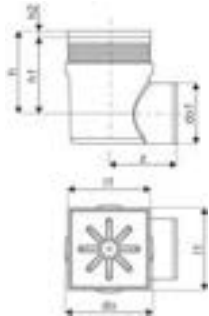

Item No.	Dimensions	l1 mm	do mm	do1 mm	z mm	h mm	h1 mm	h2 mm	Pallet/ Pack	Box/M QTY	UOM	Price per m/each
1136457	150mmx150mm FI 110	149,5	158	110	122	149,2	138	11,2	190	1	pce	26,23
1136456	100mmx100mm FI 50	107	112	50	100	123,5	115,5	8	288	1	pce	16,44

Uponor Aqua Ambient point drain inlet c standard

- Connection to waste pipes DN 50 or DN 110
- Flow rate: DN 50 0,8 l/s, DN 110 1,4 l/s
- Material grate: stainless-steel
- Material body: Polypropylene



Item No.	Dimensions	l1 mm	do mm	do1 mm	z mm	h mm	h1 mm	h2 mm	Pallet/ Pack	Box/M QTY	UOM	Price per m/each
1136458	FI 50	107	210	50	100	123,5	83,4	40,1	180	1	pce	20,42

Aqua Ambient

Uponor Aqua Ambient point drain inlet down classic/arco

- Connection to waste pipes DN 50
- Flow rate: 0,8 l/s
- Material grate: stainless-steel
- Material body: polypropylene

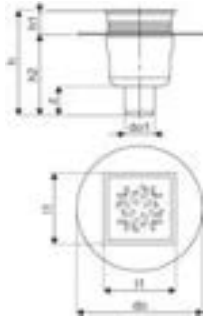

Item No.	Dimensions	l1 mm	do mm	do1 mm	z mm	h mm	h1 mm	h2 mm	Pallet/ Pack	Box/M QTY	UOM	Price per m/each
1136462	FI 50	120	210	49,2	48,7	176,8	38,4	135,9	180	1	pce	30,27

Uponor Aqua Ambient point drain inlet down classic/spot

- Connection to waste pipes DN 50
- Flow rate: 0,8 l/s
- Material grate: stainless-steel
- Material body: polypropylene



Item No.	Dimensions	l1 mm	do mm	do1 mm	z mm	h mm	h1 mm	h2 mm	Pallet/ Pack	Box/M QTY	UOM	Price per m/each
1136463	FI 50	120	210	49	48,7	176,8	38,4	135,9	180	1	pce	32,68

Aqua Ambient

Uponor Aqua Ambient point drain inlet down classic/cube

- Connection to waste pipes DN 50
- Flow rate: 0,8 l/s
- Material grate: stainless-steel
- Material body: polypropylene

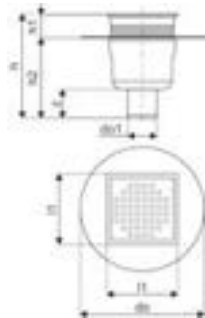

Item No.	Dimensions	l1 mm	do mm	do1 mm	z mm	h mm	h1 mm	h2 mm	Pallet/ Pack	Box/M QTY	UOM	Price per m/each
1136464	FI 50	120	210	49	48,7	176,8	38,4	135,9	180	1	pce	30,86

Uponor Aqua Ambient point drain inlet pass super/arco

- Connection to waste pipes DN 50
- Flow rate: 0,4 l/s
- For low floor constructions
- Material grate: stainless steel
- Material body: polypropylene

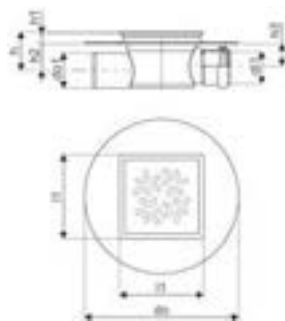

Item No.	Dimensions	di mm	l1 mm	do mm	do1 mm	h mm	h1 mm	h2 mm	Pallet/ Pack	Box/M QTY	UOM	Price per m/each
1136465	FI 50	45,7	120	220	50	55	38	38	300	1	pce	34,50

Aqua Ambient

Uponor Aqua Ambient point drain inlet pass super/spot

- Connection to waste pipes DN 50
- Flow rate: 0,4 l/s
- For low floor constructions
- Material grate: stainless steel
- Material body: polypropylene



Item No.	Dimensions	di1 mm	l1 mm	do mm	do1 mm	h mm	h1 mm	h2 mm	Pallet/ Pack	Box/M QTY	UOM	Price per m/each
1136466	FI 50	45,7	120	220	50	55	38	38	300	1	pce	40,18

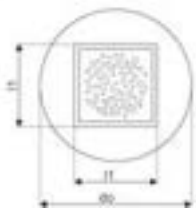

Uponor Aqua Ambient point drain inlet down standard

- Connection to waste pipes DN 50 or DN 110
- Flow rate: DN 50 0,8 l/s, DN 110 1,4 l/s
- Material grate: stainless-steel
- Material body: polypropylene

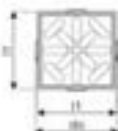
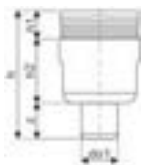

Item No.	Dimensions	l1 mm	do mm	do1 mm	z mm	h mm	h1 mm	h2 mm	Pallet/ Pack	Box/M QTY	UOM	Price per m/each
1136469	100mmx100mm FI 50	107	112	50	49	175,8	38,5	88,5	336	1	pce	16,32
1136470	150mmx150mm FI 110	149,5	158	110	58	163	57,7	10,5	196	1	pce	25,55

Aqua Ambient

Uponor Aqua Ambient point drain inlet down c standard

- Connection to waste pipes DN 50 or DN 110
- Flow rate: DN 50 0,8 l/s, DN 110 1,4 l/s
- Material grate: stainless-steel
- Material body: polypropylene

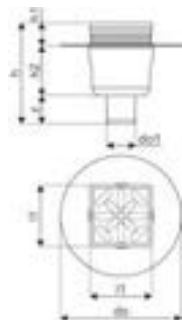

Item No.	Dimensions	l1 mm	do mm	do1 mm	z mm	h mm	h1 mm	h2 mm	Pallet/ Pack	Box/M QTY	UOM	Price per m/each
1136471	FI 50	107	210	50	49	176	40,1	86,9	180	1	pce	19,22

Multipurpose Applications



Malleable Fittings



GF Malleable iron threaded fittings are renowned for their high quality, high strength, and durability.

Made from the highest quality Whiteheart annealed cast iron, our wide range gives designers and installers complete design versatility to ensure every system fits perfectly to the building without the need to assemble multiple fittings in order to make a single transition or connection.

Specification

- Unique Whiteheart ductile Cast Iron to EN-GJMW-400-5 to BS EN 1562, design symbol A
- Thread type BSP - R or Rp to BS EN 10226-1 / ISO 7-1
- Union or flat-nut thread types to BS EN 228-1
- Manufactured to BS EN 10242 (ISO 49)
- Cast Iron is fire class A1 to BS EN 13501-1 (CWFT) acc. to Commission Decision 96/603/EC (as amended)
- Natural Black or Galvanized (99.995 zinc)
- Coated with medical-grade oil for corrosion protection
- Suitable for systems covered by the Pressure Equipment Safety Regulation:2016
- Max. pressure 25 bar up to 120 degrees, between 120-300 degrees use interpolated values, Max. 20bar at 300 degrees
- Sizes from 1/4" to 4"

Benefits

- Unique, highly engineered thread technology
- Increased wall thickness to handle higher forces
- Low manufacturing tolerances exceeding those specified within the standards
- Proven and trusted, for the most demanding conditions
- Steel-like mechanical properties by special heat treatment
- Natural black or Galvanized (99.995 zinc)
- Treated with medical oil for corrosion protection
- Made in Austria
- Sustainable production with green energy
- We have our own waterplant

Application

- Heating - LTHW, MTHW and HTHW
- Steam
- Chilled water and cooling applications
- Compressed air
- Fuel gases
- Fuel oils
- Fire defence / sprinklers

Malleable Cast Iron Fittings - Assortment Overview



Malleable Fittings

GF Malleable Fittings long sweep bend 1 90deg

- Long sweep bend 90°, ISO/EN G4
- Male / female

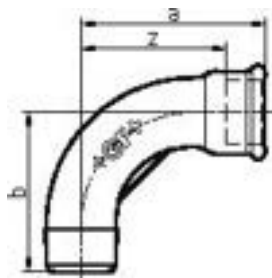

Item No.	Item no. GF	Dimensions	z	Pallet/ Pack	Box/M QTY	UOM	Price per m/each
1152727	770001101	1/8 B	41 42 19 0,039	150	10	pce	10,41
1152739	770001201	1/8 G	41 42 19 0,04	150	10	pce	15,73
1152728	770001102	1/4 B	47 48 23 0,058	80	10	pce	7,19
1152740	770001202	1/4 G	47 48 23 0,06	80	10	pce	10,86
1152729	770001103	3/8 B	57 56 27 0,104	150	10	pce	7,98
1152741	770001203	3/8 G	57 56 27 0,1092	150	10	pce	12,11
1152734	770001108	1 1/2 B	141 136 62 0,894	540	20	pce	47,96
1152730	770001104	1/2 B	66 64 32 0,165	80	10	pce	8,82
1152742	770001204	1/2 G	66 64 32 0,1733	80	10	pce	13,51
1152731	770001105	3/4 B	83 79 38 0,258	40	10	pce	14,08
1152743	770001205	3/4 G	83 79 38 0,27	40	10	pce	19,04
1152732	770001106	1 B	102 98 46 0,392	1080	20	pce	20,24
1152744	770001206	1 G	102 98 46 0,43	1080	20	pce	31,02
1152733	770001107	1 1/4 B	127 123 55 0,693	648	12	pce	36,29
1152745	770001207	1 1/4 G	127 123 55 0,719	648	12	pce	54,57
1152746	770001208	1 1/2 G	141 136 62 0,92	540	20	pce	72,87
1152735	770001109	2 B	170 168 75 1,52	270	10	pce	81,75
1152747	770001209	2 G	170 168 75 1,59	270	10	pce	122,72
1152736	770001110	2 1/2 B	214 211 92 2,83	135	5	pce	167,35
1152748	770001210	2 1/2 G	214 211 92 2,668	135	5	pce	259,47
1152737	770001111	3 B	249 244 107 4,23	108	4	pce	234,45
1152749	770001211	3 G	249 244 107 4,33	108	4	pce	363,54
1152738	770001112	4 B	224	27	1	pce	426,30
1152750	770001212	4 G	317 313 135 7,14	27	1	pce	661,04

Malleable Fittings

GF Malleable Fittings short bend 1A 90deg

- Short bend 90°, ISO/EN D4
- Male / female

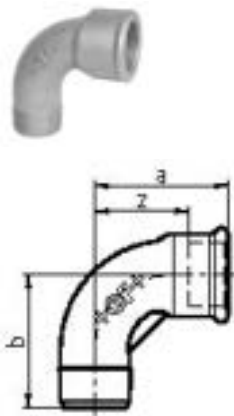

Item No.	Item no. GF	Dimensions	z	Pallet/ Pack	Box/M QTY	UOM	Price per m/each
1152796	770011102	1/4 B	37 42 23 0,062	100	10	pce	7,84
1152797	770011103	3/8 B	45 50 27 0,093	70	10	pce	9,30
1152808	770011203	3/8 G	45 50 27 0,1005	70	10	pce	15,05
1152798	770011104	1/2 B	56 61 32 0,143	80	10	pce	6,53
1152807	770011202	1/4 V	20	100	10	pce	12,56
1152809	770011204	1/2 G	56 61 32 0,152	80	10	pce	10,63
1152799	770011105	3/4 B	64 69 38 0,216	50	10	pce	9,56
1152810	770011205	3/4 G	64 69 38 0,2192	50	10	pce	17,46
1152800	770011106	1 B	80 86 46 0,328	1890	35	pce	14,16
1152811	770011206	1 G	80 86 46 0,336	1890	35	pce	24,47
1152801	770011107	1 1/4 B	98 104 55 0,539	810	15	pce	21,62
1152812	770011207	1 1/4 G	98 104 55 0,566	810	15	pce	42,39
1152802	770011108	1 1/2 B	110 116 62 0,705	675	25	pce	34,10
1152813	770011208	1 1/2 G	110 116 62 0,732	675	25	pce	62,15
1152803	770011109	2 B	132 140 75 1,166	405	15	pce	59,59
1152814	770011209	2 G	132 140 75 1,186	405	15	pce	107,11
1152804	770011110	2 1/2 B	153 161 92 1,79	216	8	pce	108,24
1152815	770011210	2 1/2 G	153 161 92 1,855	216	8	pce	181,09
1152805	770011111	3 B	171 181 107 2,523	162	6	pce	194,33
1152816	770011211	3 G	171 181 107 2,5853	162	6	pce	325,23
1152806	770011112	4 B	222 233 135 4,675	54	2	pce	481,43
1152817	770011212	4 G	222 233 135 4,791	54	2	pce	795,70

Malleable Fittings

GF Malleable Fittings long sweep bend 2 90deg

- Long sweep bend 90°, ISO/EN G1
- Female / female

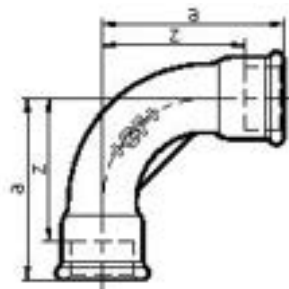

Item No.	Item no. GF	Dimensions	L mm	W mm	H mm	W kg	Pallet/ Pack	Box/M QTY	UOM	Price per m/each
1152762	770002202	1/4 G	52	52	23	0,104	5760	80	pce	11,51
1152751	770002102	1/4 B	52	52	23	0,097	5760	80	pce	7,62
1152752	770002103	3/8 B	62	62	27	0,141	100	10	pce	9,35
1152763	770002203	3/8 G	62	62	27	0,146	100	10	pce	14,14
1152753	770002104	1/2 B	71	71	32	0,215	60	10	pce	8,73
1152764	770002204	1/2 G	71	71	32	0,23	60	10	pce	13,48
1152754	770002105	3/4 B	88	88	38	0,317	2160	40	pce	15,14
1152765	770002205	3/4 G	88	88	38	0,335	2160	40	pce	23,14
1152755	770002106	1 B	108	108	46	0,536	1080	20	pce	20,84
1152766	770002206	1 G	108	108	46	0,556	1080	20	pce	31,66
1152756	770002107	1 1/4 B	133	133	55	0,79	648	12	pce	39,51
1152767	770002207	1 1/4 G	133	133	55	0,8292	648	12	pce	60,39
1152757	770002108	1 1/2 B	147	147	62	1,042	432	8	pce	48,19
1152768	770002208	1 1/2 G	147	147	62	1,045	432	8	pce	73,66
1152758	770002109	2 B	178	178	75	1,74	216	8	pce	67,04
1152769	770002209	2 G	178	178	75	1,766	216	8	pce	102,41
1152759	770002110	2 1/2 B	222	222	92	2,897	108	4	pce	180,82
1152770	770002210	2 1/2 G	222	222	92	2,984	108	4	pce	280,39
1152760	770002111	3 B	259	259	107	4,27	108	4	pce	245,41
1152771	770002211	3 G	259	259	107	4,89	108	4	pce	380,49
1152761	770002112	4 B	328	328	135	8,38	36	2	pce	464,78
1152772	770002212	4 G	328	328	135	8,55	36	2	pce	720,63

Malleable Fittings

GF Malleable Fittings short bend 2A 90deg

- Short bend 90°, ISO/EN D1
- Female / female

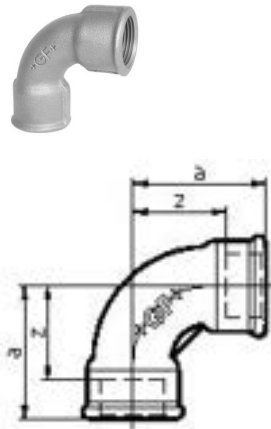

Item No.	Item no. GF	Dimensions	L mm	W mm	H mm	W kg	Pallet/ Pack	Box/M QTY	UOM	Price per m/each
1152818	770012102	1/4 B	42	42	23	0,061	5760	80	pce	9,34
1152829	770012202	1/4 G	42	42	23	0,064	5760	80	pce	14,38
1152819	770012103	3/8 B	50	50	27	0,105	50	10	pce	6,92
1152830	770012203	3/8 G	50	50	27	0,11	50	10	pce	11,12
1152820	770012104	1/2 B	61	61	32	0,168	70	10	pce	6,02
1152831	770012204	1/2 G	61	61	32	0,175	70	10	pce	10,97
1152821	770012105	3/4 B	69	69	38	0,238	40	10	pce	8,58
1152832	770012205	3/4 G	69	69	38	0,258	40	10	pce	15,71
1152822	770012106	1 B	86	86	46	0,39	1620	30	pce	12,14
1152833	770012206	1 G	86	86	46	0,398	1620	30	pce	21,88
1152823	770012107	1 1/4 B	104	104	55	0,636	810	30	pce	22,03
1152834	770012207	1 1/4 G	104	104	55	0,678	810	30	pce	40,03
1152824	770012108	1 1/2 B	116	116	62	0,807	540	20	pce	29,40
1152835	770012208	1 1/2 G	116	116	62	0,844	540	20	pce	47,73
1152825	770012109	2 B	140	140	75	1,305	324	12	pce	41,39
1152836	770012209	2 G	140	140	75	1,4	324	12	pce	74,51
1152826	770012110	2 1/2 B	161	161	92	2,08	216	8	pce	88,38
1152837	770012210	2 1/2 G	161	161	92	2,12	216	8	pce	181,09
1152827	770012111	3 B	181	181	107	2,565	162	6	pce	179,19
1152838	770012211	3 G	181	181	107	2,63	162	6	pce	313,26
1152828	770012112	4 B	233	233	135	6,115	54	2	pce	392,80
1152839	770012212	4 G	233	233	135	6,29	54	2	pce	657,24

GF Malleable Fittings long sweep bend 3 90deg

- Long sweep bend 90°, ISO/EN G8
- Male / male

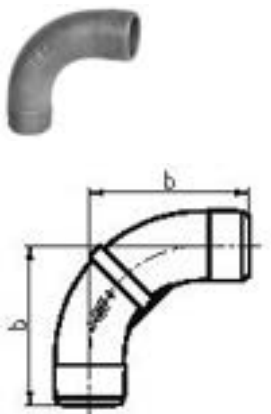

Item No.	Item no. GF	Dimensions	L mm	W mm	H mm	W kg	Pallet/ Pack	Box/M QTY	UOM	Price per m/each
1152779	770003102	1/4 B	40	40	14	0,0428	16200	300	pce	20,11
1152787	770003202	1/4 G	40	40	14	0,0475	16200	300	pce	30,40
1152780	770003103	3/8 B	51	51	18	0,0767	8100	150	pce	17,38
1152788	770003203	3/8 G	51	51	18	0,0797	8100	150	pce	26,32
1152781	770003104	1/2 B	59	59	22	0,107	50	10	pce	21,00
1152789	770003204	1/2 G	59	59	22	0,115	50	10	pce	32,11
1152782	770003105	3/4 B	74	74	27	0,186	30	10	pce	23,52
1152790	770003205	3/4 G	74	74	27	0,1925	30	10	pce	36,12
1152783	770003106	1 B	92	92	34	0,32	1890	35	pce	34,56
1152791	770003206	1 G	92	92	34	0,337	1890	35	pce	52,40
1152792	770003207	1 1/4 G	117	117	43	0,598	810	15	pce	107,18
1152784	770003107	1 1/4 B	117	117	43	0,57	810	15	pce	70,40
1152785	770003108	1 1/2 B	130	130	49	0,74	540	10	pce	98,80
1152793	770003208	1 1/2 G	130	130	49	0,7762	540	10	pce	148,46
1152786	770003109	2 B	160	160	60	1,258	270	5	pce	117,88
1152794	770003209	2 G	160	160	60	1,2941	270	5	pce	179,20
1152795	770003210	2 1/2 G	203	203	76	2,18	162	6	pce	388,73

Malleable Fittings

GF Malleable Fittings long sweep bend 40 45deg

- Long sweep bend 45°, ISO/EN G4/45°
- Male / female

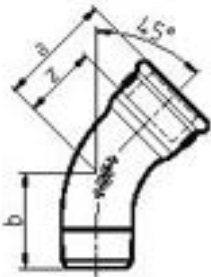

Item No.	Item no. GF	Dimensions	L mm	W mm	H mm	W kg	Pallet/ Pack	Box/M QTY	UOM	Price per m/each
1152846	770040102	1/4 B	32	46	19	0,05	100	10	pce	12,99
1152857	770040202	1/4 G	32	46	19	0,0528	100	10	pce	19,60
1152847	770040103	3/8 B	38	53	23	0,06	100	10	pce	11,81
1152858	770040203	3/8 G	38	53	23	0,062	100	10	pce	17,87
1152848	770040104	1/2 B	45	65	27	0,118	100	10	pce	8,28
1152859	770040204	1/2 G	45	65	27	0,1246	100	10	pce	14,08
1152849	770040105	3/4 B	55	78	32	0,179	60	10	pce	12,54
1152860	770040205	3/4 G	55	78	32	0,191	60	10	pce	18,92
1152850	770040106	1 B	67	92	38	0,271	80	10	pce	18,14
1152861	770040206	1 G	67	92	38	0,2826	80	10	pce	27,75
1152851	770040107	1 1/4 B	83	117	46	0,462	1080	40	pce	33,75
1152862	770040207	1 1/4 G	83	117	46	0,481	1080	40	pce	50,72
1152852	770040108	1 1/2 B	92	126	55	0,593	810	15	pce	40,87
1152863	770040208	1 1/2 G	92	126	55	0,613	810	15	pce	61,32
1152853	770040109	2 B	112	152	62	1,081	405	15	pce	64,40
1152864	770040209	2 G	112	152	62	1,133	405	15	pce	96,72
1152854	770040110	2 1/2 B	139	186	75	1,715	216	8	pce	179,48
1152865	770040210	2 1/2 G	139	186	75	1,775	216	8	pce	278,33
1152855	770040111	3 B	158	213	92	2,36	135	5	pce	204,89
1152866	770040211	3 G	158	213	92	2,43	135	5	pce	317,71
1152856	770040112	4 B	200	273	107	4,66	54	2	pce	467,51
1152867	770040212	4 G	200	273	107	4,8	54	2	pce	724,91

Malleable Fittings

GF Malleable Fittings long sweep bend 41 45deg

- Long sweep bend 45°, ISO/EN G1/45°
- Female / female

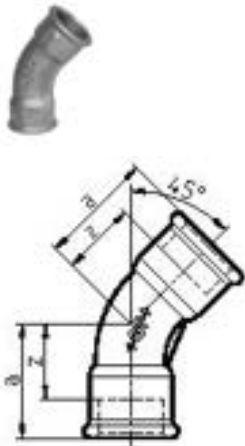

Item No.	Item no. GF	Dimensions	L mm	W mm	H mm	W kg	Pallet/ Pack	Box/M QTY	UOM	Price per m/each
1152868	770041103	3/8 B	43	60	27	0,1023	3600	50	pce	14,43
1152877	770041203	3/8 G	43	60	27	0,108	3600	50	pce	21,84
1152869	770041104	1/2 B	49	71	32	0,162	80	10	pce	14,16
1152878	770041204	1/2 G	49	71	32	0,169	80	10	pce	21,48
1152870	770041105	3/4 B	60	84	38	0,195	50	10	pce	17,71
1152879	770041205	3/4 G	60	84	38	0,2	50	10	pce	26,90
1152871	770041106	1 B	71	101	46	0,29	30	10	pce	23,35
1152880	770041206	1 G	71	101	46	0,303	30	10	pce	35,47
1152872	770041107	1 1/4 B	88	127	55	0,588	810	15	pce	44,19
1152881	770041207	1 1/4 G	88	127	55	0,607	810	15	pce	66,68
1152873	770041108	1 1/2 B	98	136	62	0,737	648	12	pce	57,80
1152882	770041208	1 1/2 G	98	136	62	0,7609	648	12	pce	87,12
1152874	770041109	2 B	117	161	75	1,1587	405	15	pce	80,26
1152883	770041209	2 G	117	161	75	1,1907	405	15	pce	120,45
1152875	770041110	2 1/2 B	143	197	92	1,77	216	8	pce	152,11
1152884	770041210	2 1/2 G	143	197	92	1,825	216	8	pce	235,88
1152876	770041111	3 B	164	227	107	2,75	162	6	pce	200,06
1152885	770041211	3 G	164	227	107	2,84	162	6	pce	310,19
1152886	770041212	4 G	207	283	135	4,83	54	2	pce	680,81

GF Malleable Fittings bend 50 30deg

- Bend 30°
- Male / female

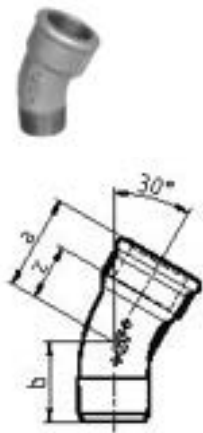

Item No.	Item no. GF	Dimensions	L mm	W mm	H mm	W kg	Pallet/ Pack	Box/M QTY	UOM	Price per m/each
1152893	770050204	1/2 G	39	58	32	0,1115	60	10	pce	20,87
1152894	770050205	3/4 G	46	69	38	0,1635	80	10	pce	28,26
1152895	770050206	1 G	56	84	46	0,254	50	10	pce	46,32
1152896	770050207	1 1/4 G	68	101	55	0,4	1080	20	pce	79,14
1152897	770050208	1 1/2 G	76	108	62	0,502	1080	20	pce	102,32
1152898	770050209	2 G	94	128	75	0,8283	540	10	pce	123,17
1152899	770050210	2 1/2 G	116	156	92	1,42	324	6	pce	264,56
1152900	770050211	3 G	134	180	107	1,75	216	4	pce	376,26
1152901	770050212	4 G	170	229	135	4,06	81	3	pce	752,49

Malleable Fittings

GF Malleable Fittings bend 51 30deg

- Bend 30°
- Female / female

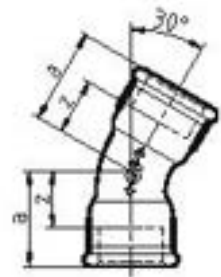

Item No.	Item no. GF	Dimensions	L mm	W mm	H mm	W kg	Pallet/ Pack	Box/M QTY	UOM	Price per m/each
1152902	770051204	1/2 G	42	64	32	0,1004	40	10	pce	28,25
1152903	770051205	3/4 G	49	75	38	0,157	50	10	pce	39,44
1152904	770051206	1 G	62	92	46	0,335	1620	30	pce	51,90
1152905	770051207	1 1/4 G	75	111	55	0,404	1080	20	pce	86,38
1152906	770051208	1 1/2 G	83	118	62	0,503	810	15	pce	104,43
1152907	770051209	2 G	99	140	75	1,04	432	8	pce	152,72

GF Malleable Fittings bend 53 15deg

- Bend 15°
- Male / female



Item No.	Item no. GF	Dimensions	L mm	W mm	H mm	W kg	Pallet/ Pack	Box/M QTY	UOM	Price per m/each
1152908	770053204	1/2 G	36	52	32	0,1013	50	10	pce	25,39
1152909	770053205	3/4 G	39	61	38	0,1213	40	10	pce	33,88
1152910	770053206	1 G	47	70	46	0,1769	50	10	pce	41,20
1152911	770053207	1 1/4 G	57	81	55	0,2774	1620	30	pce	61,59
1152912	770053208	1 1/2 G	64	85	62	0,345	1350	25	pce	81,15
1152913	770053209	2 G	77	99	75	0,647	810	15	pce	107,52
1152914	770053210	2 1/2 G	91	122	92	0,798	432	8	pce	229,91

GF Malleable Fittings bend 54 15deg

- Bend 15°
- Female / female



Item No.	Item no. GF	Dimensions	L mm	W mm	H mm	W kg	Pallet/ Pack	Box/M QTY	UOM	Price per m/each
1152915	770054204	1/2 G	39	58	32	0,149	2880	40	pce	33,31
1152916	770054205	3/4 G	44	69	38	0,193	2160	30	pce	41,79
1152917	770054206	1 G	52	77	46	0,279	2160	40	pce	60,98
1152918	770054207	1 1/4 G	65	94	55	0,419	720	10	pce	97,19
1152919	770054208	1 1/2 G	69	99	62	0,421	810	15	pce	119,28
1152920	770054209	2 G	85	108	75	0,698	540	10	pce	155,09

Malleable Fittings

GF Malleable Fittings return bend 60

- Return bend
- Female / female

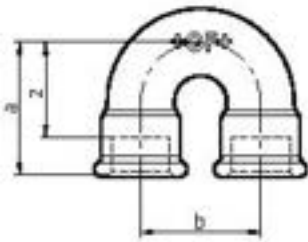

Item No.	Item no. GF	Dimensions	L mm	W mm	H mm	W kg	Pallet/ Pack	Box/M QTY	UOM	Price per m/each
1152921	770060104	1/2 B	70	56	32	0,176	2160	30	pce	34,78
1152927	770060204	1/2 G	70	56	32	0,1873	2160	30	pce	52,77
1152922	770060105	3/4 B	88	66	38	0,37	720	10	pce	56,55
1152928	770060205	3/4 G	88	66	38	0,382	720	10	pce	86,36
1152923	770060106	1 B	110	81	46	0,524	720	10	pce	70,56
1152929	770060206	1 G	110	81	46	0,537	720	10	pce	107,69
1152924	770060107	1 1/4 B	131	95	55	0,724	810	15	pce	104,46
1152930	770060207	1 1/4 G	131	95	55	0,705	810	15	pce	139,63
1152925	770060108	1 1/2 B	151	105	62	0,94	540	10	pce	124,42
1152931	770060208	1 1/2 G	151	105	62	0,97	540	10	pce	189,13
1152926	770060109	2 B	177	120	75	1,307	324	6	pce	190,81
1152932	770060209	2 G	177	120	75	1,395	324	6	pce	285,12

GF Malleable Fittings crossover bend reduced 85

- * D=3/4
- Female / female

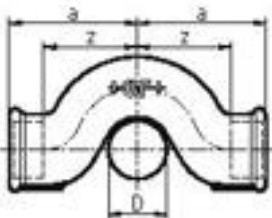

Item No.	Item no. GF	Dimensions	L mm	W mm	H mm	W kg	Pallet/ Pack	Box/M QTY	UOM	Price per m/each
1152938	770085115	1/2 - 3/4 B	98	47	28	0,2528	50	10	pce	26,76
1152944	770085215	1/2 - 3/4 G	98	47	28	0,208	50	10	pce	40,48

GF Malleable Fittings crossover bend 85

- Crossover
- * D=3/4
- Female / female

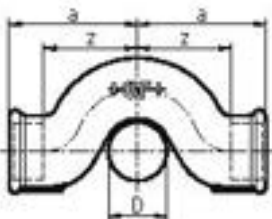

Item No.	Item no. GF	Dimensions	L mm	W mm	H mm	W kg	Pallet/ Pack	Box/M QTY	UOM	Price per m/each
1152933	770085103	3/8 B	76	37	27	0,1473	2160	30	pce	18,46
1152939	770085203	3/8 G	76	37	27	0,127	2160	30	pce	26,38
1152934	770085104	1/2 B	94	53	32	0,277	50	10	pce	12,98
1152940	770085204	1/2 G	94	53	32	0,287	50	10	pce	20,81
1152935	770085105	3/4 B	110	57	38	0,325	2160	40	pce	22,39
1152941	770085205	3/4 G	110	57	38	0,313	2160	40	pce	31,95
1152936	770085106	1 B	140	70	46	0,5129	1080	20	pce	40,26
1152942	770085206	1 G	140	70	46	0,538	1080	20	pce	57,48
1152937	770085107	1 1/4 B	170	87	55	0,83	540	10	pce	83,63
1152943	770085207	1 1/4 G	170	87	55	0,862	540	10	pce	125,50

Malleable Fittings

GF Malleable Fittings elbow 90 90deg

- Elbow 90°, equal, ISO/EN A1
- Female / female

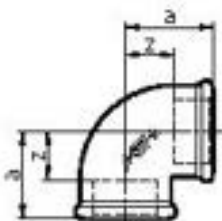

Item No.	Item no. GF	Dimensions	z				Pallet/ Pack	Box/M QTY	UOM	Price per m/each
		mm								
1152946	770090101	1/8 B	29	29	19	0,038	150	10	pce	5,34
1152975	770090201	1/8 G	29	29	19	0,0401	150	10	pce	10,28
1152947	770090102	1/4 B	33	33	23	0,059	200	10	pce	4,06
1152976	770090202	1/4 G	33	33	23	0,0625	200	10	pce	5,79
1152948	770090103	3/8 B	39	39	27	0,085	150	10	pce	3,79
1152977	770090203	3/8 G	39	39	27	0,0883	150	10	pce	5,79
1152949	770090104	1/2 B	44	44	32	0,13	100	10	pce	3,35
1152978	770090204	1/2 G	44	44	32	0,1326	100	10	pce	5,05
1152950	770090105	3/4 B	52	52	38	0,181	60	10	pce	4,61
1152979	770090205	3/4 G	52	52	38	0,194	60	10	pce	6,92
1152951	770090106	1 B	61	61	46	0,265	30	10	pce	7,08
1152980	770090206	1 G	61	61	46	0,271	30	10	pce	10,75
1152952	770090107	1 1/4 B	73	73	55	0,458	1080	20	pce	12,45
1152981	770090207	1 1/4 G	73	73	55	0,4682	1080	20	pce	20,98
1152953	770090108	1 1/2 B	81	81	62	0,523	810	30	pce	20,90
1152982	770090208	1 1/2 G	81	81	62	0,5331	810	30	pce	31,42
1152954	770090109	2 B	96	96	75	0,833	540	20	pce	24,49
1152983	770090209	2 G	96	96	75	0,847	540	20	pce	36,75
1152955	770090110	2 1/2 B	115	115	92	1,293	324	12	pce	56,57
1152984	770090210	2 1/2 G	115	115	92	1,315	324	12	pce	82,85
1152956	770090111	3 B	132	132	107	1,794	162	6	pce	83,13
1152985	770090211	3 G	132	132	107	1,84	162	6	pce	121,69
1152957	770090112	4 B	164	164	135	3,175	81	3	pce	203,96
1152986	770090212	4 G	164	164	135	3,28	81	3	pce	248,82

Malleable Fittings

GF Malleable Fittings elbow reducer 90 90deg

- Elbow 90°, reducing, ISO/EN A1
- Female / female

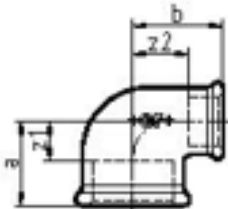

Item No.	Item no. GF	Dimensions	L mm	W mm	H mm	W kg	Pallet/ Pack	Box/M QTY	UOM	Price per m/each
1152958	770090115	1/4 - 1/8 B	32	30	23	0,041	10800	150	pce	13,79
1152987	770090215	1/4 - 1/8 G	32	30	23	0,0552	10800	150	pce	20,81
1152959	770090116	3/8 - 1/4 B	37	35	27	0,06	5760	80	pce	7,56
1152988	770090216	3/8 - 1/4 G	37	35	27	0,062	5760	80	pce	11,95
1152960	770090117	1/2 - 1/4 B	40	38	32	0,064	80	10	pce	12,11
1152989	770090217	1/2 - 1/4 G	40	38	32	0,0695	80	10	pce	19,07
1152961	770090118	1/2 - 3/8 B	42	40	32	0,106	120	10	pce	7,30
1152990	770090218	1/2 - 3/8 G	42	40	32	0,111	120	10	pce	11,59
1152962	770090120	3/4 - 1/2 B	50	46	38	0,149	80	10	pce	6,35
1152991	770090220	3/4 - 1/2 G	50	46	38	0,1555	80	10	pce	12,18
1152963	770090121	1 - 1/2 B	57	48	46	0,199	50	10	pce	7,32
1152992	770090221	1 - 1/2 G	57	48	46	0,212	50	10	pce	12,61
1152964	770090122	1 - 3/4 B	59	54	46	0,224	50	10	pce	9,84
1152993	770090222	1 - 3/4 G	59	54	46	0,232	50	10	pce	16,62
1152973	770090132	1 1/4 - 1/2 B	66	51	55	0,276	2700	50	pce	13,63
1153003	770090232	1 1/4 - 1/2 G	66	51	55	0,284	2700	50	pce	25,14
1152965	770090123	1 1/4 - 3/4 B	69	55	55	0,282	2160	40	pce	20,98
1152994	770090223	1 1/4 - 3/4 G	69	55	55	0,292	2160	40	pce	34,41
1152966	770090124	1 1/4 - 1 B	70	63	55	0,337	1620	30	pce	13,10
1152995	770090224	1 1/4 - 1 G	70	63	55	0,358	1620	30	pce	23,31
1152967	770090125	1 1/2 - 3/4 B	75	57	62	0,344	1620	30	pce	24,97
1152996	770090225	1 1/2 - 3/4 G	75	57	62	0,3717	1620	30	pce	44,35
1152968	770090126	1 1/2 - 1 B	77	65	62	0,3986	1620	30	pce	23,85
1152997	770090226	1 1/2 - 1 G	77	65	62	0,414	1620	30	pce	42,33
1152969	770090127	1 1/2 - 1 1/4 B	79	74	62	0,47	1080	20	pce	33,76
1152998	770090227	1 1/2 - 1 1/4 G	79	74	62	0,482	1080	20	pce	60,74
1152970	770090128	2 - 1 B	90	67	75	0,532	810	15	pce	41,99
1152999	770090228	2 - 1 G	90	67	75	0,5466	810	15	pce	74,59
1152971	770090129	2 - 1 1/4 B	92	76	75	0,5149	810	15	pce	54,97
1153000	770090229	2 - 1 1/4 G	92	76	75	0,5419	810	15	pce	97,61
1152972	770090130	2 - 1 1/2 B	93	83	75	0,676	648	12	pce	46,47
1153001	770090230	2 - 1 1/2 G	93	83	75	0,6617	648	12	pce	75,58
1153002	770090231	2 1/2 - 2 G	112	99	92	0,91	432	8	pce	198,14

Malleable Fittings

GF Malleable Fittings elbow equal 92 90deg

- Elbow 90°, equal, ISO/EN A4
- Male / female

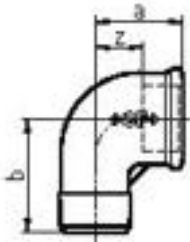

Item No.	Item no. GF	Dimensions	L mm	W mm	H mm	W kg	Pallet/ Pack	Box/M QTY	UOM	Price per m/each
1153019	770092101	1/8 B	25	35	19	0,033	150	10	pce	6,09
1153042	770092201	1/8 G	25	35	19	0,0328	150	10	pce	9,43
1153020	770092102	1/4 B	28	40	23	0,052	300	10	pce	4,26
1153043	770092202	1/4 G	28	40	23	0,054	300	10	pce	6,09
1153021	770092103	3/8 B	34	46	27	0,078	200	10	pce	4,52
1153044	770092203	3/8 G	34	46	27	0,082	200	10	pce	7,35
1153022	770092104	1/2 B	39	53	32	0,109	100	10	pce	3,75
1153045	770092204	1/2 G	39	53	32	0,1135	100	10	pce	5,70
1153023	770092105	3/4 B	47	62	38	0,166	60	10	pce	5,03
1153046	770092205	3/4 G	47	62	38	0,168	60	10	pce	7,58
1153024	770092106	1 B	55	75	46	0,303	30	10	pce	8,37
1153047	770092206	1 G	55	75	46	0,3142	30	10	pce	12,67
1153025	770092107	1 1/4 B	67	88	55	0,398	1350	25	pce	14,68
1153048	770092207	1 1/4 G	67	88	55	0,392	1350	25	pce	26,95
1153026	770092108	1 1/2 B	75	96	62	0,521	810	30	pce	24,63
1153049	770092208	1 1/2 G	75	96	62	0,5282	810	30	pce	37,00
1153027	770092109	2 B	88	112	75	0,789	540	20	pce	31,69
1153050	770092209	2 G	88	112	75	0,8185	540	20	pce	47,62
1153028	770092110	2 1/2 B	107	134	92	1,288	270	10	pce	68,49
1153051	770092210	2 1/2 G	107	134	92	1,33	270	10	pce	137,53
1153029	770092111	3 B	122	152	107	1,83	162	6	pce	127,41
1153052	770092211	3 G	122	152	107	1,878	162	6	pce	188,07
1153030	770092112	4 B	153	186	135	4	108	4	pce	222,83
1153053	770092212	4 G	153	186	135	4,025	108	4	pce	322,38

Malleable Fittings

GF Malleable Fittings elbow red 92 90deg

- Elbow 90°, female thread reduced, ISO/EN A4
- Male / female

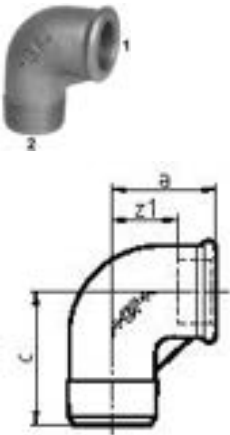

Item No.	Item no. GF	Dimensions	L mm	W mm	H mm	W kg	Pallet/ Pack	Box/M QTY	UOM	Price per m/each
1153037	770092124	3/8 - 1/2 B	39	51	27	0,094	70	10	pce	13,96
1153061	770092224	3/8 - 1/2 G	39	51	27	0,0985	70	10	pce	20,98
1153031	770092116	1/2 - 3/8 B	35	49	32	0,0774	70	10	pce	20,33
1153054	770092216	1/2 - 3/8 G	35	49	32	0,0828	70	10	pce	30,78
1153038	770092125	1/2 - 3/4 B	48	58	32	0,142	40	10	pce	21,85
1153062	770092225	1/2 - 3/4 G	48	58	32	0,1499	40	10	pce	42,90
1153032	770092117	3/4 - 1/2 B	41	59	38	0,14	40	10	pce	19,07
1153055	770092217	3/4 - 1/2 G	41	59	38	0,1475	40	10	pce	28,91
1153039	770092126	3/4 - 1 B	56	69	38	0,2216	20	10	pce	31,97
1153063	770092226	3/4 - 1 G	56	69	38	0,234	20	10	pce	63,00
1153041	770092130	1 - 1/2 B	43	69	46	0,208	50	10	pce	15,05
1153065	770092230	1 - 1/2 G	43	69	46	0,219	50	10	pce	22,16
1153033	770092118	1 - 3/4 B	52	65	46	0,19	50	10	pce	26,32
1153056	770092218	1 - 3/4 G	52	65	46	0,218	50	10	pce	39,95
1153040	770092127	1 - 1 1/4 B	66	82	46	0,347	1620	30	pce	51,25
1153064	770092227	1 - 1 1/4 G	66	82	46	0,355	1620	30	pce	80,92
1153057	770092219	1 1/4 - 3/4 G	58	79	55	0,308	2160	40	pce	52,19
1153034	770092120	1 1/4 - 1 B	57	84	55	0,316	1620	30	pce	27,76
1153058	770092220	1 1/4 - 1 G	57	84	55	0,332	1620	30	pce	43,06
1153059	770092221	1 1/2 - 1 G	64	93	62	0,42	1080	20	pce	109,47
1153035	770092121	1 1/2 - 1 B	64	93	62	0,408	1080	20	pce	72,94
1153036	770092122	1 1/2 - 1 1/4 B	74	95	62	0,465	1080	20	pce	52,48
1153060	770092222	1 1/2 - 1 1/4 G	74	95	62	0,4858	1080	20	pce	79,79

GF Malleable Fittings elbow 94 90deg

- Elbow 90°
- Male / male

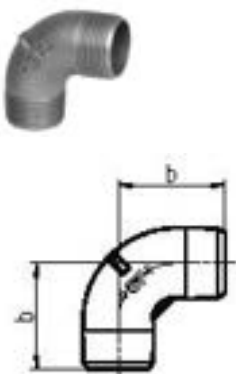

Item No.	Item no. GF	Dimensions	L mm	W mm	H mm	W kg	Pallet/ Pack	Box/M QTY	UOM	Price per m/each
1153074	770094103	3/8 B	38	38	18	0,0534	10800	200	pce	15,63
1153075	770094104	1/2 B	48	48	22	0,0899	60	10	pce	11,56
1153082	770094204	1/2 G	48	48	22	0,092	60	10	pce	17,27
1153076	770094105	3/4 B	54	54	27	0,122	40	10	pce	12,58
1153083	770094205	3/4 G	54	54	27	0,137	40	10	pce	20,41
1153077	770094106	1 B	64	64	34	0,19	20	10	pce	22,07
1153084	770094206	1 G	64	64	34	0,199	20	10	pce	31,84
1153078	770094107	1 1/4 B	78	78	43	0,292	1080	15	pce	33,12
1153085	770094207	1 1/4 G	78	78	43	0,3387	1080	15	pce	50,75
1153079	770094108	1 1/2 B	84	84	49	0,4225	720	10	pce	60,59
1153086	770094208	1 1/2 G	84	84	49	0,4285	720	10	pce	92,78
1153080	770094109	2 B	98	98	60	0,682	648	12	pce	62,53
1153087	770094209	2 G	98	98	60	0,703	648	12	pce	95,79

Malleable Fittings

GF Malleable Fittings union elbow flat seat 95

- Union elbow, flat seat, ISO/EN UA1
- Supplied without sealing gaskets
- a and z2 include the seal thickness as per table "Sealing Gasket Dimension".
- '374 G' refers to the thread size 'G' according to ISO 228 of the union nut 374
- * Inside hexagon
- Female / female

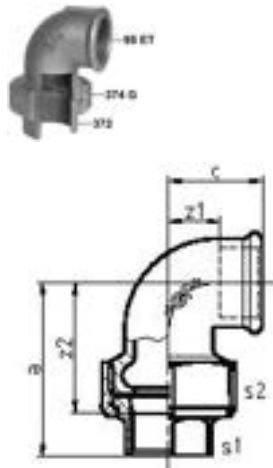

Item No.	Item no. GF	Dimensions	L mm	W mm	H mm	W kg	Pallet/ Pack	Box/M QTY	UOM	Price per m/each
1153092	770095103	3/8 B	52	66	32	0,139	2880	40	pce	32,55
1153099	770095203	3/8 G	52	66	32	0,143	2880	40	pce	49,16
1153093	770095104	1/2 B	59	74	41	0,2446	60	10	pce	27,20
1153100	770095204	1/2 G	59	74	41	0,2517	60	10	pce	41,11
1153094	770095105	3/4 B	70	81	48	0,353	30	10	pce	29,88
1153101	770095205	3/4 G	70	81	48	0,364	30	10	pce	45,16
1153095	770095106	1 B	79	95	55	0,505	1350	25	pce	33,65
1153102	770095206	1 G	79	95	55	0,526	1350	25	pce	50,87
1153096	770095107	1 1/4 B	86	110	67	0,8172	648	12	pce	61,04
1153103	770095207	1 1/4 G	86	110	67	0,829	648	12	pce	91,65
1153097	770095108	1 1/2 B	91	121	74	1,034	540	10	pce	96,47
1153104	770095208	1 1/2 G	91	121	74	1,054	540	10	pce	144,85
1153098	770095109	2 B	108	138	90	1,596	270	5	pce	142,45
1153105	770095209	2 G	108	138	90	1,643	270	5	pce	213,91

GF Malleable Fittings union elbow taper seat 96

- Union elbow, taper seat, ISO/EN UA11
- Torque and notes for installation please find in "Technical Product Notes".
- '374 G' refers to the thread size 'G' according to ISO 228 of the union nut 374
- * Inside hexagon
- Female / female

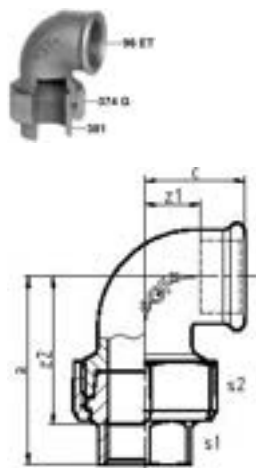

Item No.	Item no. GF	Dimensions	L mm	W mm	H mm	W kg	Pallet/ Pack	Box/M QTY	UOM	Price per m/each
1153106	770096102	1/4 B	37	60	28	0,1097	6480	120	pce	37,31
1153116	770096202	1/4 G	37	60	28	0,1135	6480	120	pce	56,45
1153107	770096103	3/8 B	43	66	32	0,1435	2880	40	pce	33,85
1153117	770096203	3/8 G	43	66	32	0,15	2880	40	pce	51,21
1153108	770096104	1/2 B	51	74	41	0,258	60	10	pce	28,13
1153118	770096204	1/2 G	51	74	41	0,2653	60	10	pce	44,88
1153109	770096105	3/4 B	60	81	48	0,349	30	10	pce	33,04
1153119	770096205	3/4 G	60	81	48	0,3574	30	10	pce	51,76
1153110	770096106	1 B	68	95	55	0,533	1350	25	pce	47,77
1153120	770096206	1 G	68	95	55	0,5466	1350	25	pce	71,25
1153111	770096107	1 1/4 B	82	110	67	0,865	648	12	pce	63,11
1153121	770096207	1 1/4 G	82	110	67	0,897	648	12	pce	94,29
1153112	770096108	1 1/2 B	91	121	74	1,065	540	20	pce	71,52
1153122	770096208	1 1/2 G	91	121	74	1,1	540	20	pce	106,87
1153113	770096109	2 B	108	138	90	1,675	270	5	pce	110,31
1153123	770096209	2 G	108	138	90	1,6906	270	5	pce	187,34
1153114	770096110	2 1/2 B	131	176	111	2,723	162	3	pce	303,30
1153124	770096210	2 1/2 G	131	176	111	2,822	162	3	pce	470,24
1153115	770096111	3 B	148	188	131	3,492	108	4	pce	391,82
1153125	770096211	3 G	148	188	131	3,571	108	4	pce	607,57

Malleable Fittings

GF Malleable Fittings union elbow flat seat 97

- Union elbow, flat seat, ISO/EN UA2
- Supplied without sealing gaskets
- b includes the seal thickness as per table "Sealing Gasket Dimension".
- '374 G' refers to the thread size 'G' according to ISO 228 of the union nut 374
- Male / female

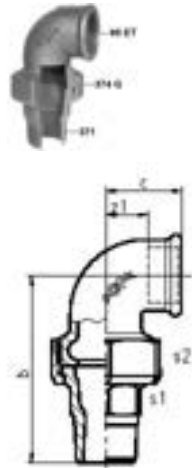

Item No.	Item no. GF	Dimensions	L mm	W mm	H mm	W kg	Pallet/ Pack	Box/M QTY	UOM	Price per m/each
1153127	770097103	3/8 B	43	79	32	0,1425	2880	40	pce	27,49
1153134	770097203	3/8 G	43	79	32	0,148	2880	40	pce	41,58
1153128	770097104	1/2 B	51	92	41	0,2798	50	10	pce	24,88
1153135	770097204	1/2 G	51	92	41	0,2887	50	10	pce	37,60
1153129	770097105	3/4 B	60	101	48	0,3945	1620	30	pce	33,85
1153136	770097205	3/4 G	60	101	48	0,4077	1620	30	pce	51,21
1153130	770097106	1 B	68	116	55	0,61	1080	20	pce	37,94
1153137	770097206	1 G	68	116	55	0,6016	1080	20	pce	57,33
1153131	770097107	1 1/4 B	82	135	67	0,9378	540	10	pce	70,17
1153138	770097207	1 1/4 G	82	135	67	0,965	540	10	pce	106,64
1153132	770097108	1 1/2 B	91	146	74	1,168	405	15	pce	105,00
1153139	770097208	1 1/2 G	91	146	74	1,191	405	15	pce	157,62
1153133	770097109	2 B	108	166	90	1,846	270	5	pce	157,76
1153140	770097209	2 G	108	166	90	1,872	270	5	pce	236,95

GF Malleable Fittings union elbow taper seat 98

- Union elbow, taper seat, ISO/EN UA12
- Torque and notes for installation please find in "Technical Product Notes".
- '374 G' refers to the thread size 'G' according to ISO 228 of the union nut 374
- Male / female

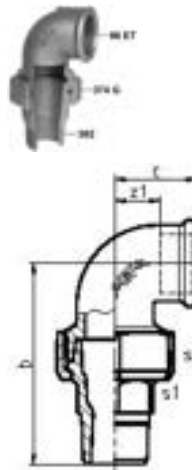

Item No.	Item no. GF	Dimensions	L mm	W mm	H mm	W kg	Pallet/ Pack	Box/M QTY	UOM	Price per m/each
1153141	770098102	1/4 B	37	73	28	0,123	4320	80	pce	31,97
1153151	770098202	1/4 G	37	73	28	0,1275	4320	80	pce	48,40
1153142	770098103	3/8 B	43	79	32	0,1625	2880	40	pce	29,31
1153152	770098203	3/8 G	43	79	32	0,1685	2880	40	pce	44,37
1153143	770098104	1/2 B	51	92	41	0,289	50	10	pce	30,15
1153153	770098204	1/2 G	51	92	41	0,2939	50	10	pce	46,04
1153144	770098105	3/4 B	60	101	48	0,399	1620	30	pce	37,78
1153154	770098205	3/4 G	60	101	48	0,411	1620	30	pce	56,97
1153145	770098106	1 B	68	117	55	0,6	1080	20	pce	53,02
1153155	770098206	1 G	68	117	55	0,6216	1080	20	pce	79,95
1153146	770098107	1 1/4 B	82	135	67	0,973	540	10	pce	66,36
1153156	770098207	1 1/4 G	82	135	67	1,003	540	10	pce	99,11
1153147	770098108	1 1/2 B	91	146	74	1,211	405	15	pce	79,93
1153157	770098208	1 1/2 G	91	146	74	1,2265	405	15	pce	121,57
1153148	770098109	2 B	108	166	90	1,91	270	10	pce	129,78
1153158	770098209	2 G	108	166	90	1,9396	270	10	pce	193,93
1153149	770098110	2 1/2 B	131	210	111	3,215	162	6	pce	341,41
1153159	770098210	2 1/2 G	131	210	111	3,324	162	6	pce	529,40
1153150	770098111	3 B	148	221	131	4,005	108	4	pce	462,25
1153160	770098211	3 G	148	221	131	4,096	108	4	pce	716,78

Malleable Fittings

GF Malleable Fittings union elbow flat seat 100

- Union elbow, flat seat
- Supplied without sealing gaskets
- a and z include the seal thickness as per table "Sealing Gasket Dimension".
- '374 G' refers to the thread size 'G' according to ISO 228 of the union nut 374
- Male / female

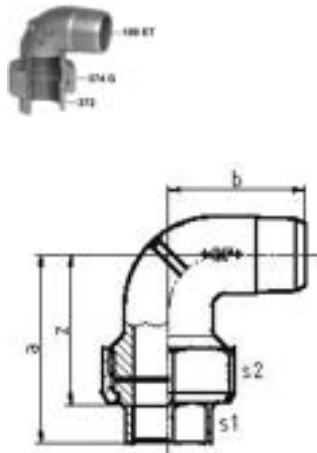

Item No.	Item no. GF	Dimensions	L mm	W mm	H mm	W kg	Pallet/ Pack	Box/M QTY	UOM	Price per m/each
1153161	770100104	1/2 B	62	69	41	0,2521	2700	50	pce	40,32
1153164	770100204	1/2 G	62	69	41	0,2577	2700	50	pce	60,96
1153162	770100105	3/4 B	70	75	48	0,332	1620	30	pce	46,94
1153165	770100205	3/4 G	70	75	48	0,341	1620	30	pce	70,99
1153163	770100106	1 B	82	88	55	0,5073	1350	25	pce	54,53
1153166	770100206	1 G	82	88	55	0,5228	1350	25	pce	58,50

GF Malleable Fittings union elbow flat seat 101

- Union elbow, flat seat
- Supplied without sealing gaskets
- a includes the seal thickness as per table "Sealing Gasket Dimension".
- '374 G' refers to the thread size 'G' according to ISO 228 of the union nut 374.
- Male / male

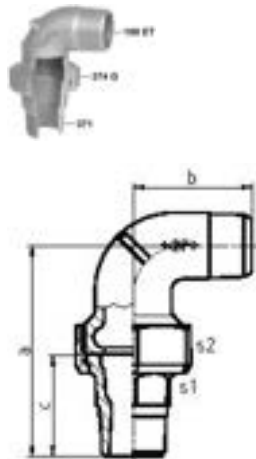

Item No.	Item no. GF	Dimensions	L mm	W mm	H mm	W kg	Pallet/ Pack	Box/M QTY	UOM	Price per m/each
1153167	770101104	1/2 B	62	88	41	0,2873	3240	60	pce	40,32
1153170	770101204	1/2 G	62	88	41	0,2947	3240	60	pce	60,96
1153168	770101105	3/4 B	70	95	48	0,3735	1890	35	pce	49,77
1153171	770101205	3/4 G	70	95	48	0,3847	1890	35	pce	75,27
1153169	770101106	1 B	82	110	55	0,5671	1080	20	pce	57,36
1153172	770101206	1 G	82	110	55	0,5866	1080	20	pce	86,72

Malleable Fittings

GF Malleable Fittings union elbow taper seat 102

- Union elbow, taper seat
- Torque and notes for installation please find in "Technical Product Notes".
- '374 G' refers to the thread size 'G' according to ISO 228 of the union nut 374
- Male / female

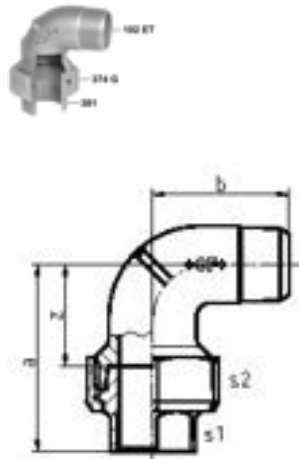

Item No.	Item no. GF	Dimensions	L mm	W mm	H mm	W kg	Pallet/ Pack	Box/M QTY	UOM	Price per m/each
1153173	770102104	1/2 B	62	70	41	0,2653	2160	30	pce	41,74
1153176	770102204	1/2 G	62	70	41	0,2693	2160	30	pce	63,12
1153174	770102105	3/4 B	70	75	48	0,3356	1890	35	pce	51,26
1153177	770102205	3/4 G	70	75	48	0,3434	1890	35	pce	77,47
1153175	770102106	1 B	82	88	55	0,5213	1350	25	pce	60,70
1153178	770102206	1 G	82	88	55	0,5346	1350	25	pce	91,77

GF Malleable Fittings union elbow taper seat 103

- Union elbow, taper seat
- Torque and notes for installation please find in "Technical Product Notes".
- '374 G' refers to the thread size 'G' according to ISO 228 of the union nut 374
- Male / male

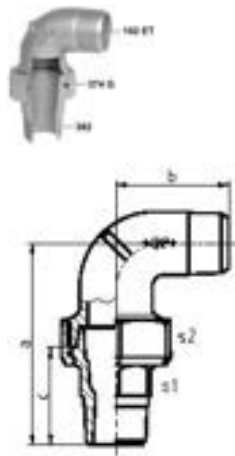

Item No.	Item no. GF	Dimensions	L mm	W mm	H mm	W kg	Pallet/ Pack	Box/M QTY	UOM	Price per m/each
1153179	770103104	1/2 B	62	87	39	0,2963	2700	50	pce	42,66
1153182	770103204	1/2 G	62	87	39	0,306	2700	50	pce	64,53
1153180	770103105	3/4 B	70	95	48	0,386	1890	35	pce	53,08
1153183	770103205	3/4 G	70	95	48	0,397	1890	35	pce	80,31
1153181	770103106	1 B	82	110	55	0,5876	1080	20	pce	60,70
1153184	770103206	1 G	82	110	55	0,6096	1080	20	pce	91,77

Malleable Fittings

GF Malleable Fittings elbow 120 45deg

- Elbow 45°, ISO/EN A1/45°
- Female / female

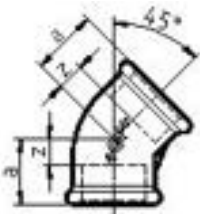

Item No.	Item no. GF	Dimensions	L mm	W mm	H mm	W kg	Pallet/ Pack	Box/M QTY	UOM	Price per m/each
1153185	770120103	3/8 B	35	42	27	0,077	70	10	pce	10,14
1153194	770120203	3/8 G	35	42	27	0,08	70	10	pce	16,13
1153186	770120104	1/2 B	39	47	32	0,113	60	10	pce	7,99
1153195	770120204	1/2 G	39	47	32	0,118	60	10	pce	13,23
1153187	770120105	3/4 B	47	54	38	0,114	40	10	pce	9,85
1153196	770120205	3/4 G	47	54	38	0,1185	40	10	pce	16,31
1153188	770120106	1 B	55	61	46	0,236	50	10	pce	14,64
1153197	770120206	1 G	55	61	46	0,243	50	10	pce	22,41
1153189	770120107	1 1/4 B	67	74	55	0,341	1620	30	pce	28,69
1153198	770120207	1 1/4 G	67	74	55	0,35	1620	30	pce	48,84
1153190	770120108	1 1/2 B	74	81	62	0,442	720	10	pce	35,19
1153199	770120208	1 1/2 G	74	81	62	0,453	720	10	pce	57,82
1153191	770120109	2 B	90	97	75	0,715	540	10	pce	48,33
1153200	770120209	2 G	90	97	75	0,736	540	10	pce	78,34
1153192	770120110	2 1/2 B	107	111	92	1,021	405	15	pce	75,57
1153201	770120210	2 1/2 G	107	111	92	1,0827	405	15	pce	121,60
1153193	770120111	3 B	126	126	107	1,155	270	10	pce	135,14
1153202	770120211	3 G	126	126	107	1,143	270	10	pce	213,33

GF Malleable Fittings elbow 121 45deg

- Elbow 45°, ISO/EN A1/45°
- Male / female

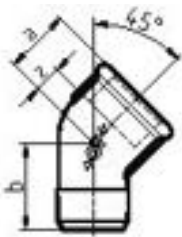

Item No.	Item no. GF	Dimensions	L mm	W mm	H mm	W kg	Pallet/ Pack	Box/M QTY	UOM	Price per m/each
1153209	770121103	3/8 B	31	49	27	0,062	100	10	pce	9,05
1153218	770121203	3/8 G	31	49	27	0,0638	100	10	pce	13,93
1153210	770121104	1/2 B	36	53	32	0,098	60	10	pce	8,17
1153219	770121204	1/2 G	36	53	32	0,101	60	10	pce	13,61
1153211	770121105	3/4 B	43	62	38	0,132	40	10	pce	10,29
1153220	770121205	3/4 G	43	62	38	0,138	40	10	pce	17,97
1153212	770121106	1 B	52	74	46	0,213	50	10	pce	15,59
1153221	770121206	1 G	52	74	46	0,2216	50	10	pce	26,77
1153213	770121107	1 1/4 B	62	83	55	0,313	1620	30	pce	30,67
1153222	770121207	1 1/4 G	62	83	55	0,322	1620	30	pce	57,48
1153214	770121108	1 1/2 B	69	91	62	0,398	1350	25	pce	35,12
1153223	770121208	1 1/2 G	69	91	62	0,412	1350	25	pce	60,80
1153215	770121109	2 B	84	109	75	0,66	648	12	pce	50,29
1153224	770121209	2 G	84	109	75	0,6833	648	12	pce	80,27
1153216	770121110	2 1/2 B	101	116	92	0,936	432	8	pce	98,04
1153225	770121210	2 1/2 G	101	116	92	0,975	432	8	pce	154,73
1153217	770121111	3 B	115	133	107	1,505	270	10	pce	143,02
1153226	770121211	3 G	115	133	107	1,532	270	10	pce	225,68

Malleable Fittings

GF Malleable Fittings tee equal 130

- Tee, equal, ISO/EN B1
- Female /female /female

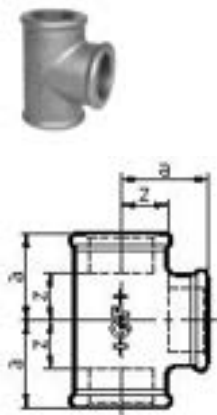

Item No.	Item no. GF	Dimensions	L mm	W mm	H mm	W kg	Pallet/ Pack	Box/M QTY	UOM	Price per m/each
1153272	770130101	1/8 B	29	38	19	0,057	100	10	pce	6,83
1153367	770130201	1/8 G	29	38	19	0,06	100	10	pce	11,02
1153273	770130102	1/4 B	33	42	23	0,086	100	10	pce	5,89
1153368	770130202	1/4 G	33	42	23	0,09	100	10	pce	8,93
1153274	770130103	3/8 B	39	50	27	0,124	100	10	pce	4,97
1153369	770130203	3/8 G	39	50	27	0,133	100	10	pce	8,15
1153275	770130104	1/2 B	44	56	32	0,175	60	10	pce	4,61
1153370	770130204	1/2 G	44	56	32	0,182	60	10	pce	6,92
1153276	770130105	3/4 B	52	66	38	0,241	40	10	pce	6,69
1153371	770130205	3/4 G	52	66	38	0,2494	40	10	pce	10,14
1153277	770130106	1 B	61	76	46	0,367	1350	25	pce	9,58
1153372	770130206	1 G	61	76	46	0,3843	1350	25	pce	14,55
1153278	770130107	1 1/4 B	73	90	55	0,553	810	30	pce	16,90
1153373	770130207	1 1/4 G	73	90	55	0,572	810	30	pce	28,72
1153279	770130108	1 1/2 B	81	100	62	0,708	540	20	pce	25,94
1153374	770130208	1 1/2 G	81	100	62	0,72	540	20	pce	39,33
1153280	770130109	2 B	96	116	75	1,14	324	12	pce	37,37
1153375	770130209	2 G	96	116	75	1,174	324	12	pce	56,65
1153281	770130110	2 1/2 B	115	138	92	1,783	270	10	pce	81,94
1153376	770130210	2 1/2 G	115	138	92	1,839	270	10	pce	147,36
1153282	770130111	3 B	132	156	107	2,784	135	5	pce	99,73
1153377	770130211	3 G	132	156	107	2,83	135	5	pce	157,45
1153283	770130112	4 B	164	192	135	5,258	81	3	pce	230,06
1153378	770130212	4 G	164	192	135	5,2829	81	3	pce	311,37

Malleable Fittings

GF Malleable Fittings tee reduced 130

- Tee, reducing or increasing on the branch, reducing on the run, ISO/EN 81
- Female /female /female

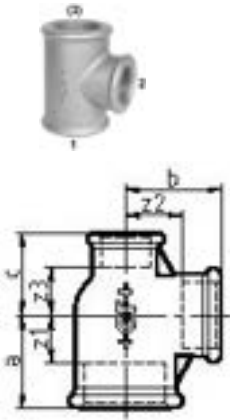

Item No.	Item no. GF	Dimensions	z1 mm	z2 mm	Pallet/ Pack	Box/M QTY	UOM	Price per m/each
1153284	770130115	3/8 - 1/4 B	13	13	120	10	pce	18,18
1153379	770130215	3/8 - 1/4 G	13	13	120	10	pce	25,47
1153285	770130116	3/8 - 1/2 B	16	13	40	10	pce	13,44
1153380	770130216	3/8 - 1/2 G	16	13	40	10	pce	16,81
1153286	770130117	1/2 - 1/4 B	11	14	40	10	pce	12,73
1153381	770130217	1/2 - 1/4 G	11	14	40	10	pce	18,85
1153287	770130118	1/2 - 3/8 - 3/8 B	42	51 32 0,095	40	10	pce	12,98
1153382	770130218	1/2 - 3/8 - 3/8 G	42	51 32 0,1	40	10	pce	16,25
1153288	770130119	1/2 - 3/8 B	13	16	80	10	pce	9,89
1153383	770130219	1/2 - 3/8 G	13	16	80	10	pce	14,03
1153289	770130120	1/2 - 1/2 - 3/8 B	44	54 32 0,1635	30	10	pce	18,32
1153384	770130220	1/2 - 1/2 - 3/8 G	44	54 32 0,1702	30	10	pce	22,97
1153290	770130121	1/2 - 3/4 B	18	15	60	10	pce	10,07
1153385	770130221	1/2 - 3/4 G	18	15	60	10	pce	16,78
1153299	770130130	1/2 - 1 B	21	15	50	10	pce	20,62
1153394	770130230	1/2 - 1 G	21	15	50	10	pce	32,31
1153291	770130122	3/4 - 1/4 B	11	17	70	10	pce	16,75
1153386	770130222	3/4 - 1/4 G	11	17	70	10	pce	23,70
1153293	770130124	3/4 - 3/8 B	13	18	60	10	pce	12,26
1153388	770130224	3/4 - 3/8 G	13	18	60	10	pce	17,15
1153292	770130123	3/4 - 3/8 - 1/2 B	47	54 38 0,1833	30	10	pce	14,93
1153387	770130223	3/4 - 3/8 - 1/2 G	47	54 38 0,187	30	10	pce	18,65
1153294	770130125	3/4 - 1/2 - 3/8 B	50	56 38 0,191	30	10	pce	26,15
1153389	770130225	3/4 - 1/2 - 3/8 G	50	56 38 0,1967	30	10	pce	32,67
1153296	770130127	3/4 - 1/2 B	15	18	40	10	pce	6,23
1153391	770130227	3/4 - 1/2 G	15	18	40	10	pce	11,07
1153295	770130126	3/4 - 1/2 - 1/2 B	50	58 38 0,208	60	10	pce	8,04
1153390	770130226	3/4 - 1/2 - 1/2 G	50	58 38 0,212	60	10	pce	17,08

Malleable Fittings

GF Malleable Fittings tee reduced 130

- Malleable cast iron
- Tee, reducing or increasing on the branch, reducing on the run
- ISO/EN B1

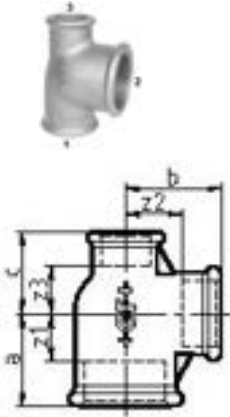

Item No.	Item no. GF	Dimensions	z1 mm	z2 mm	Pallet/ Pack	Box/M QTY	UOM	Price per m/each	
1153297	770130128	3/4 - 3/4 - 3/8 B	52	61 38	0,199	50	10	pce	15,65
1153392	770130228	3/4 - 3/4 - 3/8 G	52	61 38	0,205	50	10	pce	24,27
1153298	770130129	3/4 - 3/4 - 1/2 B	52	64 38	0,238	50	10	pce	10,49
1153393	770130229	3/4 - 3/4 - 1/2 G	52	64 38	0,248	50	10	pce	20,68
1153300	770130131	3/4 - 1 - 1/2 B	54	70 46	0,271	40	10	pce	20,48
1153395	770130231	3/4 - 1 - 1/2 G	54	70 46	0,294	40	10	pce	32,31
1153301	770130132	3/4 - 1 B	21	18		40	10	pce	17,28
1153396	770130232	3/4 - 1 G	21	18		40	10	pce	29,31
1153302	770130133	1 - 1/4 B	11	21		40	10	pce	28,60
1153397	770130233	1 - 1/4 G	11	21		40	10	pce	44,96
1153303	770130134	1 - 3/8 B	13	22		40	10	pce	18,49
1153398	770130234	1 - 3/8 G	13	22		40	10	pce	29,01
1153306	770130137	1 - 1/2 B	15	21		1620	30	pce	8,66
1153304	770130135	1 - 1/2 - 1/2 B		57 60 46	0,253	40	10	pce	19,69
1153401	770130237	1 - 1/2 G	15	21		1620	30	pce	15,00
1153399	770130235	1 - 1/2 - 1/2 G		57 60 46	0,261	40	10	pce	30,45
1153305	770130136	1 - 1/2 - 3/4 B		57 62 46	0,266	40	10	pce	11,88
1153400	770130236	1 - 1/2 - 3/4 G		57 62 46	0,275	40	10	pce	23,30
1153307	770130138	1 - 3/4 - 1/2 B		59 66 46	0,271	40	10	pce	17,28
1153308	770130139	1 - 3/4 - 3/4 B		59 68 46	0,301	1620	30	pce	13,86
1153316	770130147	1 1/4 - 1/2 - 1 B		66 66 55	0,357	1890	35	pce	17,97
1153411	770130247	1 1/4 - 1/2 - 1 G		66 66 55	0,374	1890	35	pce	41,65
1153320	770130151	1 1/4 - 3/4 B	17	26		1080	20	pce	16,65
1153318	770130149	1 1/4 - 3/4 - 3/4 B		69 69 55	0,3567	1620	30	pce	29,48
1153415	770130251	1 1/4 - 3/4 G	17	26		1080	20	pce	31,95
1153319	770130150	1 1/4 - 3/4 - 1 B		69 71 55	0,397	1620	30	pce	26,23
1153414	770130250	1 1/4 - 3/4 - 1 G		69 71 55	0,409	1620	30	pce	43,80

Malleable Fittings

GF Malleable Fittings tee reduced 130

- Malleable cast iron
- Tee, reducing or increasing on the branch, reducing on the run
- ISO/EN B1

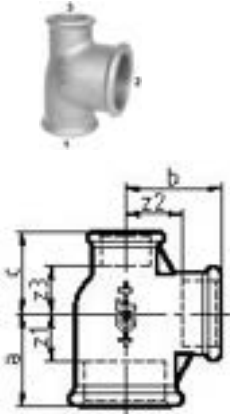

Item No.	Item no. GF	Dimensions	z1 mm	z2 mm	Pallet/ Pack	Box/M QTY	UOM	Price per m/each	
1153321	770130153	1 1/4 - 1 - 3/4 B	70	76 55	0,373	1350	25	pce	28,83
1153416	770130253	1 1/4 - 1 - 3/4 G	70	76 55	0,3827	1350	25	pce	46,30
1153323	770130155	1 1/4 - 1 B	21	25		810	15	pce	17,23
1153418	770130255	1 1/4 - 1 G	21	25		810	15	pce	31,50
1153322	770130154	1 1/4 - 1 - 1 B	70	78 55	0,437	1080	20	pce	19,14
1153417	770130254	1 1/4 - 1 - 1 G	70	78 55	0,446	1080	20	pce	44,34
1153324	770130156	1 1/4 - 1 1/4 - 1/2 B	73	83 55	0,492	1080	20	pce	29,79
1153419	770130256	1 1/4 - 1 1/4 - 1/2 G	73	83 55	0,51	1080	20	pce	54,47
1153325	770130157	1 1/4 - 1 1/4 - 3/4 B	73	86 55	0,499	1080	20	pce	35,21
1153420	770130257	1 1/4 - 1 1/4 - 3/4 G	73	86 55	0,511	1080	20	pce	64,10
1153328	770130160	1 1/4 - 1 1/2 - 1 B	74	94 62	0,561	810	15	pce	45,50
1153423	770130260	1 1/4 - 1 1/2 - 1 G	74	94 62	0,58	810	15	pce	71,37
1153326	770130158	1 1/4 - 1 1/4 - 1 B	73	87 55	0,526	810	15	pce	29,94
1153421	770130258	1 1/4 - 1 1/4 - 1 G	73	87 55	0,546	810	15	pce	55,15
1153329	770130161	1 1/4 - 1 1/2 B	29	27		810	15	pce	45,70
1153424	770130261	1 1/4 - 1 1/2 G	29	27		810	15	pce	70,26
1153345	770130177	1 1/4 - 2 B	35	24		540	10	pce	56,08
1153440	770130277	1 1/4 - 2 G	35	24		540	10	pce	93,49
1153331	770130163	1 1/2 - 1/2 - 1 1/4 B	73	70 62	0,448	1080	20	pce	23,13
1153426	770130263	1 1/2 - 1/2 - 1 1/4 G	73	70 62	0,462	1080	20	pce	53,57
1153334	770130166	1 1/2 - 3/4 B	19	29		810	30	pce	23,42
1153429	770130266	1 1/2 - 3/4 G	19	29		810	30	pce	39,17
1153333	770130165	1 1/2 - 3/4 - 1 1/4 B	75	74 62	0,472	1080	20	pce	38,85
1153428	770130265	1 1/2 - 3/4 - 1 1/4 G	75	74 62	0,4843	1080	20	pce	59,80
1153330	770130162	1 1/2 - 3/8 B	14	28		720	10	pce	38,85
1153425	770130262	1 1/2 - 3/8 G	14	28		720	10	pce	59,80
1153332	770130164	1 1/2 - 1/2 B	17	29		810	15	pce	19,34

Malleable Fittings

GF Malleable Fittings tee reduced 130

- Malleable cast iron
- Tee, reducing or increasing on the branch, reducing on the run
- ISO/EN B1

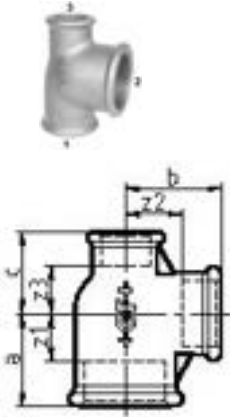

Item No.	Item no. GF	Dimensions	z1 mm	z2 mm	Pallet/ Pack	Box/M QTY	UOM	Price per m/each	
1153402	770130238	1 - 3/4 - 1/2 G	59	66	46 0,28	40	10	pce	26,72
1153309	770130140	1 - 3/4 B	18	21		1620	30	pce	10,32
1153404	770130240	1 - 3/4 G	18	21		1620	30	pce	17,29
1153403	770130239	1 - 3/4 - 3/4 G	59	68	46 0,3	1620	30	pce	23,30
1153427	770130264	1 1/2 - 1/2 G	17	29		810	15	pce	33,96
1153337	770130169	1 1/2 - 1 B	23	29		810	15	pce	22,89
1153432	770130269	1 1/2 - 1 G	23	29		810	15	pce	39,91
1153335	770130167	1 1/2 - 1 - 1 B	77	80	62 0,498	1080	20	pce	33,35
1153430	770130267	1 1/2 - 1 - 1 G	77	80	62 0,512	1080	20	pce	55,54
1153336	770130168	1 1/2 - 1 - 1 1/4 B	77	80	62 0,533	810	15	pce	30,61
1153431	770130268	1 1/2 - 1 - 1 1/4 G	77	80	62 0,549	810	15	pce	63,24
1153340	770130172	1 1/2 - 1 1/4 B	27	29		810	15	pce	29,92
1153435	770130272	1 1/2 - 1 1/4 G	27	29		810	15	pce	63,88
1153338	770130170	1 1/2 - 1 1/4 - 1 B	79	88	62 0,451	810	15	pce	47,42
1153433	770130270	1 1/2 - 1 1/4 - 1 G	79	88	62 0,465	810	15	pce	72,94
1153339	770130171	1 1/2 - 1 1/4 - 1 1/4 B	79	91	62 0,606	810	15	pce	29,77
1153434	770130271	1 1/2 - 1 1/4 - 1 1/4 G	79	91	62 0,636	810	15	pce	68,33
1153341	770130173	1 1/2 - 1 1/2 - 1/2 B	81	92	62 0,568	810	15	pce	42,60
1153436	770130273	1 1/2 - 1 1/2 - 1/2 G	81	92	62 0,585	810	15	pce	77,49
1153342	770130174	1 1/2 - 1 1/2 - 3/4 B	81	94	62 0,593	810	15	pce	51,28
1153437	770130274	1 1/2 - 1 1/2 - 3/4 G	81	94	62 0,613	810	15	pce	85,45
1153343	770130175	1 1/2 - 1 1/2 - 1 B	81	96	62 0,634	810	15	pce	47,58
1153438	770130275	1 1/2 - 1 1/2 - 1 G	81	96	62 0,654	810	15	pce	87,58
1153344	770130176	1 1/2 - 1 1/2 - 1 1/4 B	81	98	62 0,54	810	15	pce	50,40
1153439	770130276	1 1/2 - 1 1/2 - 1 1/4 G	81	98	62 0,572	810	15	pce	92,76
1153346	770130178	1 1/2 - 2 - 1 1/4 B	85	112	75 0,822	540	10	pce	66,06
1153441	770130278	1 1/2 - 2 - 1 1/4 G	85	112	75 0,621	540	10	pce	122,50
1153347	770130179	1 1/2 - 2 B	36	28		540	10	pce	51,98

Malleable Fittings

GF Malleable Fittings tee reduced 130

- Malleable cast iron
- Tee, reducing or increasing on the branch, reducing on the run
- ISO/EN B1

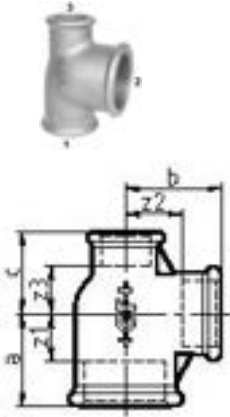

Item No.	Item no. GF	Dimensions	z1 mm	z2 mm	Pallet/ Pack	Box/M QTY	UOM	Price per m/each
1153311	770130142	1 - 1 - 1/2 B	61	72 46 0,336	1620	30	pce	15,46
1153406	770130242	1 - 1 - 1/2 G	61	72 46 0,351	1620	30	pce	30,51
1153310	770130141	1 - 1 - 3/8 B	61	70 46 0,3183	1620	30	pce	23,28
1153405	770130241	1 - 1 - 3/8 G	61	70 46 0,33	1620	30	pce	36,04
1153312	770130143	1 - 1 - 3/4 B	61	74 46 0,349	1620	30	pce	17,59
1153407	770130243	1 - 1 - 3/4 G	61	74 46 0,36	1620	30	pce	29,48
1153313	770130144	1 - 1 1/4 - 3/4 B	63	83 55 0,413	1350	25	pce	19,35
1153408	770130244	1 - 1 1/4 - 3/4 G	63	83 55 0,426	1350	25	pce	54,22
1153314	770130145	1 - 1 1/4 B	25	21	1080	20	pce	29,38
1153409	770130245	1 - 1 1/4 G	25	21	1080	20	pce	51,38
1153327	770130159	1 - 1 1/2 B	29	23	1080	20	pce	39,31
1153422	770130259	1 - 1 1/2 G	29	23	1080	20	pce	59,50
1153315	770130146	1 1/4 - 3/8 B	13	26	1620	30	pce	28,61
1153410	770130246	1 1/4 - 3/8 G	13	26	1620	30	pce	44,02
1153317	770130148	1 1/4 - 1/2 B	15	25	1350	25	pce	15,19
1153412	770130248	1 1/4 - 1/2 G	15	25	1350	25	pce	28,70
1153442	770130279	1 1/2 - 2 G	36	28	540	10	pce	95,72
1153349	770130181	2 - 1/2 B	14	35	648	12	pce	29,92
1153444	770130281	2 - 1/2 G	14	35	648	12	pce	50,42
1153348	770130180	2 - 1/2 - 1 1/2 B	86	76 75 0,609	810	15	pce	45,22
1153443	770130280	2 - 1/2 - 1 1/2 G	86	76 75 0,61	810	15	pce	82,27
1153351	770130183	2 - 3/4 B	16	35	675	25	pce	40,58
1153446	770130283	2 - 3/4 G	16	35	675	25	pce	77,88
1153350	770130182	2 - 3/4 - 1 1/2 B	88	78 75 0,6266	810	15	pce	57,36
1153445	770130282	2 - 3/4 - 1 1/2 G	88	78 75 0,645	810	15	pce	95,61
1153353	770130185	2 - 1 B	20	35	540	10	pce	33,84
1153448	770130285	2 - 1 G	20	35	540	10	pce	52,60
1153352	770130184	2 - 1 - 1 1/2 B	90	86 75 0,662	675	25	pce	52,84
1153447	770130284	2 - 1 - 1 1/2 G	90	86 75 0,68	675	25	pce	97,34
1153356	770130188	2 - 1 1/4 B	24	35	540	10	pce	40,58
1153354	770130186	2 - 1 1/4 - 1 1/4 B	92	93 75 0,7663	432	8	pce	57,43

Malleable Fittings

GF Malleable Fittings tee reduced 130

- Malleable cast iron
- Tee, reducing or increasing on the branch, reducing on the run
- ISO/EN B1

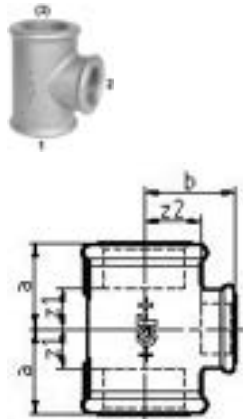

Item No.	Item no. GF	Dimensions	z1 mm	z2 mm	Pallet/ Pack	Box/M QTY	UOM	Price per m/each
1153451	770130288	2 - 1 1/4 G	24	35	540	10	pce	90,85
1153449	770130286	2 - 1 1/4 - 1 1/4 G	92	93 75 0,66	432	8	pce	104,41
1153355	770130187	2 - 1 1/4 - 1 1/2 B	92	94 75 0,77	540	10	pce	50,34
1153450	770130287	2 - 1 1/4 - 1 1/2 G	92	94 75 0,79	540	10	pce	96,79
1153358	770130191	2 - 1 1/2 B	28	36	405	15	pce	50,35
1153453	770130291	2 - 1 1/2 G	28	36	405	15	pce	104,84
1153357	770130190	2 - 1 1/2 - 1 1/2 B	93	102 75 0,791	540	10	pce	53,44
1153359	770130192	2 - 2 - 1/2 B	96	106 75 0,907	432	8	pce	93,25
1153360	770130193	2 - 2 - 3/4 B	96	108 75 0,911	540	10	pce	64,08
1153455	770130293	2 - 2 - 3/4 G	96	108 75 0,938	540	10	pce	106,85
1153361	770130194	2 - 2 - 1 B	96	110 75 0,92	432	8	pce	59,63
1153456	770130294	2 - 2 - 1 G	96	110 75 0,96	432	8	pce	109,00
1153362	770130195	2 - 2 - 1 1/4 B	96	112 75 0,972	540	10	pce	73,25
1153457	770130295	2 - 2 - 1 1/4 G	96	112 75 0,79	540	10	pce	133,17
1153363	770130196	2 - 2 - 1 1/2 B	96	113 75 0,792	432	8	pce	67,94
1153458	770130296	2 - 2 - 1 1/2 G	96	113 75 0,81	432	8	pce	114,64
1153365	770130198	2 1/2 - 1/2 B	14	43	540	10	pce	59,79
1153460	770130298	2 1/2 - 1/2 G	14	43	540	10	pce	119,00
1153366	770130199	2 1/2 - 3/4 B	18	44	405	15	pce	116,08
1153461	770130299	2 1/2 3/4 G	18	44	405	15	pce	184,52
1153232	770129115	2 1/2 - 1 B	20	43	405	15	pce	84,47
1153250	770129215	2 1/2 - 1 G	20	43	405	15	pce	132,69
1153233	770129116	2 1/2 - 1 1/4 B	25	43	270	10	pce	95,80
1153251	770129216	2 1/2 - 1 1/4 G	25	43	270	10	pce	157,22
1153234	770129118	2 1/2 - 1 1/2 B	28	44	270	10	pce	102,96
1153252	770129218	2 1/2 - 1 1/2 G	28	44	270	10	pce	159,75
1153236	770129120	2 1/2 - 2 B	34	42	270	10	pce	102,96

Malleable Fittings

GF Malleable Fittings tee reduced 130

- Malleable cast iron
- Tee, reducing or increasing on the branch, reducing on the run
- ISO/EN B1

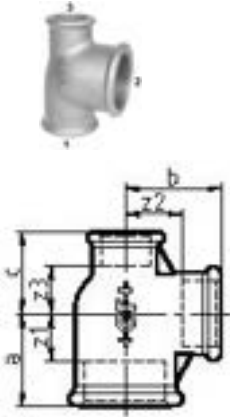

Item No.	Item no. GF	Dimensions	z1 mm	z2 mm	Pallet/ Pack	Box/M QTY	UOM	Price per m/
1153235	770129119	2 1/2 - 2 - 2 B		118 129 92	1,4	270	10	pce 119,36
1153254	770129220	2 1/2 - 2 G	34	42		270	10	pce 161,74
1153253	770129219	2 1/2 - 2 - 2 G		118 129 92	1,49	270	10	pce 237,40
1153255	770129221	2 1/2 - 2 1/2 - 1 G		117 142 92	1,3	270	10	pce 319,05
1153237	770129122	2 1/2 - 2 1/2 - 1 1/2 B		115 133 92	1,45	270	10	pce 160,85
1153256	770129222	2 1/2 - 2 1/2 - 1 1/2 G		115 133 92	1,567	270	10	pce 270,36
1153257	770129223	2 1/2 - 2 1/2 - 2 G		119 141 92	1,435	270	10	pce 326,93
1153364	770130197	2 - 2 1/2 B	42	34		270	10	pce 85,31
1153459	770130297	2 - 2 1/2 G	42	34		270	10	pce 146,82
1153239	770129124	3 - 1/2 B	15	50		270	10	pce 122,97
1153258	770129224	3 - 1/2 G	15	50		270	10	pce 228,08
1153240	770129125	3 - 3/4 B	18	51		270	10	pce 132,06
1153259	770129225	3 - 3/4 G	18	51		270	10	pce 241,98
1153241	770129126	3 - 1 B	21	50		270	10	pce 156,67
1153260	770129226	3 - 1 G	21	50		270	10	pce 241,20
1153242	770129127	3 - 1 1/4 B	25	51		270	10	pce 156,67
1153261	770129227	3 - 1 1/4 G	25	51		270	10	pce 243,00
1153243	770129128	3 - 1 1/2 B	28	52		270	10	pce 134,87
1153262	770129228	3 - 1 1/2 G	28	52		270	10	pce 209,26
1153244	770129130	3 - 2 B	34	49		270	10	pce 139,23
1153264	770129230	3 - 2 G	34	49		270	10	pce 218,70
1153263	770129229	3 - 2 - 2 G		127 124 107	1,48	270	10	pce 296,85
1153245	770129131	3 - 2 1/2 B	42	49		135	5	pce 251,83
1153265	770129231	3 - 2 1/2 G	42	49		135	5	pce 390,82
1153266	770129232	3 - 3 - 2 G		133 150 107	2,16	162	3	pce 405,62
1153246	770129133	4 - 1 B	20	63		162	6	pce 326,41
1153267	770129233	4 - 1 G	20	63		162	6	pce 506,38
1153247	770129135	4 - 1 1/2 B	28	65		108	4	pce 276,96
1153268	770129235	4 - 1 1/2 G	28	65		108	4	pce 429,76
1153248	770129136	4 - 2 B	34	62		108	4	pce 230,49
1153269	770129236	4 - 2 G	34	62		108	4	pce 362,05
1153270	770129237	4 - 2 1/2 G	41	62		108	4	pce 551,74
1153249	770129138	4 - 3 B	48	62		108	4	pce 355,57
1153271	770129238	4 - 3 G	48	62		108	4	pce 551,74

Malleable Fittings

GF Malleable Fittings pitcher tee reduced 131

- Pitcher tee, reducing on the branch, ISO/EN E1
- Swept tee to improve flow, especially on return lines

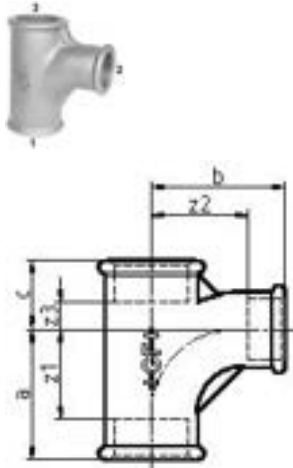

Item No.	Item no. GF	Dimensions	z1 mm	z2 mm	z3 mm	Pallet/ Pack	Box/M QTY	UOM	Price per m/each
1153509	770131116	3/4 - 1/2 B	32	35	10	30	10	pce	16,86
1153538	770131216	3/4 - 1/2 G	32	35	10	30	10	pce	38,37
1153508	770131115	3/4 - 1/2 - 1/2 B			67 71 38	40	10	pce	19,17
1153537	770131215	3/4 - 1/2 - 1/2 G			67 71 38	40	10	pce	43,67
1153510	770131117	3/4 - 3/4 - 1/2 B			68 76 38	1620	30	pce	24,60
1153512	770131119	1 - 1/2 B	32	38	11	1350	25	pce	24,56
1153540	770131219	1 - 1/2 G	32	38	11	1350	25	pce	55,96
1153511	770131118	1 - 1/2 - 3/4 B			74 74 46	1620	30	pce	20,86
1153514	770131121	1 - 3/4 B	36	39	13	1350	25	pce	21,47
1153542	770131221	1 - 3/4 G	36	39	13	1350	25	pce	48,50
1153541	770131220	1 - 3/4 - 3/4 G			77 81 46	1620	30	pce	57,00
1153513	770131120	1 - 3/4 - 3/4 B			77 81 46	1620	30	pce	26,37
1153517	770131125	1 1/4 - 1 B	47	51	17	648	12	pce	51,80
1153515	770131122	1 1/4 - 1/2 B	32	43	11	720	10	pce	42,59
1153543	770131222	1 1/4 - 1/2 G	32	43	11	720	10	pce	94,07
1153516	770131123	1 1/4 - 3/4 B	36	43	14	810	15	pce	42,50
1153544	770131223	1 1/4 - 3/4 G	36	43	14	810	15	pce	92,92
1153527	770131140	1 1/2 - 1/2 B	33	45	10	810	15	pce	41,48

GF Malleable Fittings pitcher tee reduced 131

- Pitcher tee, reducing on the branch, ISO/EN E1
- Swept tee to improve flow, especially on return lines

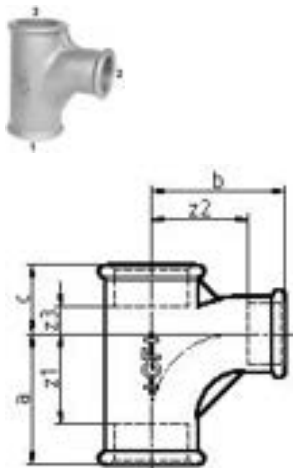

Item No.	Item no. GF	Dimensions	z1 mm	z2 mm	z3 mm	Pallet/ Pack	Box/M QTY	UOM	Price per m/each
1153518	770131126	1 1/2 - 3/4 B	36	46	14	810	15	pce	51,31
1153519	770131127	1 1/2 - 1 B	47	54	17	540	10	pce	58,38
1153520	770131128	1 1/2 - 1 1/4 B	58	60	22	540	10	pce	68,95
1153548	770131228	1 1/2 - 1 1/4 G	58	60	22	540	10	pce	140,26
1153526	770131137	2 - 1/2 B	30	51	8	540	10	pce	76,99
1153521	770131129	2 - 3/4 B	45	60	15	270	10	pce	70,90
1153522	770131130	2 - 1 B	46	60	16	270	5	pce	75,12
1153550	770131230	2 - 1 G	46	60	16	270	5	pce	152,96
1153523	770131131	2 - 1 1/4 B	56	66	21	270	5	pce	94,61
1153551	770131231	2 - 1 1/4 G	56	66	21	270	5	pce	192,50
1153524	770131132	2 - 1 1/2 B	67	75	24	270	5	pce	110,82
1153525	770131135	3 - 2 B	108	119	39	108	4	pce	275,93
1153554	770131235	3 - 2 G	108	119	39	108	4	pce	445,88

Malleable Fittings

GF Malleable Fittings pitcher tee equal 131

- Pitcher tee, equal, ISO/EN E1
- Swept tee to improve flow, especially on return lines

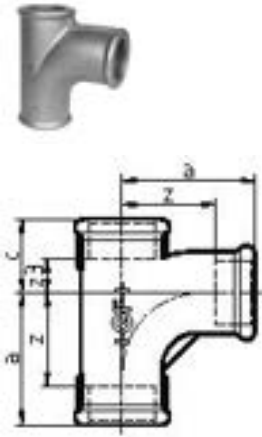

Item No.	Item no. GF	Dimensions	L mm	W mm	H mm	W kg	Pallet/ Pack	Box/M QTY	UOM	Price per m/each
1153499	770131104	1/2 B	61	69	32	0,238	50	10	pce	14,04
1153528	770131204	1/2 G	61	69	32	0,241	50	10	pce	29,85
1153500	770131105	3/4 B	69	78	38	0,336	1620	30	pce	17,47
1153529	770131205	3/4 G	69	78	38	0,344	1620	30	pce	36,81
1153501	770131106	1 B	86	96	46	0,523	1080	20	pce	26,21
1153530	770131206	1 G	86	96	46	0,5387	1080	20	pce	55,90
1153502	770131107	1 1/4 B	104	116	55	0,778	540	10	pce	38,25
1153531	770131207	1 1/4 G	104	116	55	0,802	540	10	pce	79,06
1153503	770131108	1 1/2 B	116	128	62	0,973	432	8	pce	59,14
1153532	770131208	1 1/2 G	116	128	62	1,03	432	8	pce	122,22
1153504	770131109	2 B	140	155	75	1,635	216	4	pce	83,01
1153533	770131209	2 G	140	155	75	1,684	216	4	pce	170,36
1153505	770131110	2 1/2 B	161	177	92	2,525	162	6	pce	140,74
1153534	770131210	2 1/2 G	161	177	92	2,588	162	6	pce	244,12
1153506	770131111	3 B	181	197	107	3,5	108	4	pce	219,66
1153535	770131211	3 G	181	197	107	3,755	108	4	pce	380,97
1153507	770131112	4 B	233	252	135	6,16	27	1	pce	494,21
1153536	770131212	4 G	233	252	135	6,26	27	1	pce	846,69

GF Malleable Fittings twin elbow 132

- Twin elbow, equal, ISO/EN E2
- Female, female, female

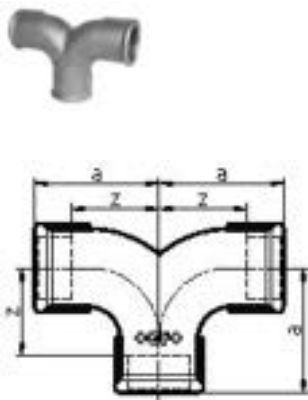

Item No.	Item no. GF	Dimensions	L mm	W mm	H mm	W kg	Pallet/ Pack	Box/M QTY	UOM	Price per m/each
1153556	770132104	1/2 B	90	61	32	0,186	2160	40	pce	19,34
1153562	770132204	1/2 G	90	61	32	0,192	2160	40	pce	38,88
1153557	770132105	3/4 B	100	69	38	0,371	1620	30	pce	21,42
1153563	770132205	3/4 G	100	69	38	0,3846	1620	30	pce	42,95
1153558	770132106	1 B	126	86	46	0,58	540	20	pce	38,68
1153564	770132206	1 G	126	86	46	0,598	540	20	pce	69,55
1153559	770132107	1 1/4 B	152	104	55	0,913	432	8	pce	74,60
1153565	770132207	1 1/4 G	152	104	55	0,87	432	8	pce	127,25
1153560	770132108	1 1/2 B	170	116	62	1,15	270	5	pce	94,45
1153566	770132208	1 1/2 G	170	116	62	1,191	270	5	pce	161,08
1153561	770132109	2 B	204	140	75	1,924	135	5	pce	121,39
1153567	770132209	2 G	204	140	75	1,98	135	5	pce	209,58

Malleable Fittings

GF Malleable Fittings tee 133

- Tee, equal
- Female/ male /female

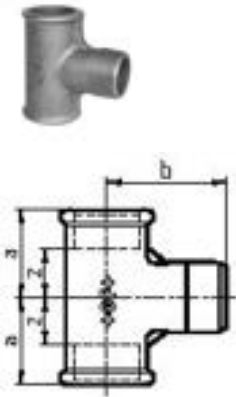

Item No.	Item no. GF	Dimensions	z mm	Pallet/ Pack	Box/M QTY	UOM	Price per m/each
1153568	770133103	3/8 B	45 44 27 0,1015	150	10	pce	18,24
1153572	770133203	3/8 G	45 44 27 0,1074	150	10	pce	27,62
1153569	770133104	1/2 B	54 50 32 0,154	80	10	pce	14,71
1153573	770133204	1/2 G	54 50 32 0,163	80	10	pce	22,20
1153570	770133105	3/4 B	64 66 38 0,248	40	10	pce	18,67
1153574	770133205	3/4 G	64 66 38 0,2605	40	10	pce	28,55
1153575	770133206	1 G	76 78 46 0,38	1620	30	pce	57,33
1153571	770133106	1 B	22	1620	30	pce	37,94

GF Malleable Fittings tee reduced 134

- Tee, reducing on branch
- Male / female / female



Item No.	Item no. GF	Dimensions	L mm	W mm	H mm	W kg	Pallet/ Pack	Box/M QTY	UOM	Price per m/each
1153584	770134116	1/2 - 1/4 B	40	58	32	0,115	4320	80	pce	36,23
1153595	770134216	1/2 - 1/4 G	40	58	32	0,12	4320	80	pce	54,84
1153585	770134118	3/4 - 1/2 B	49	70	38	0,2144	50	10	pce	28,90
1153596	770134218	3/4 - 1/2 G	49	70	38	0,2248	50	10	pce	43,75
1153586	770134119	1 - 1/2 B	58	76	46	0,292	2160	40	pce	41,00
1153597	770134219	1 - 1/2 G	58	76	46	0,305	2160	40	pce	61,66

Malleable Fittings

GF Malleable Fittings tee 134

- Tee, equal
- Male / female / female

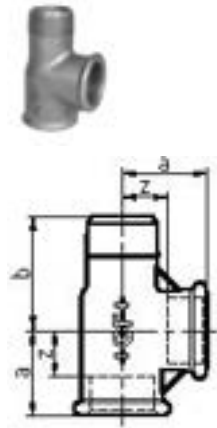

Item No.	Item no. GF	Dimensions	L mm	W mm	H mm	W kg	Pallet/ Pack	Box/M QTY	UOM	Price per m/each
1153576	770134102	1/4 B	34	50	23	0,062	80	10	pce	18,02
1153587	770134202	1/4 G	34	50	23	0,0833	80	10	pce	27,24
1153577	770134103	3/8 B	38	56	27	0,111	60	10	pce	18,02
1153588	770134203	3/8 G	38	56	27	0,111	60	10	pce	21,84
1153578	770134104	1/2 B	43	64	32	0,161	80	10	pce	17,68
1153589	770134204	1/2 G	43	64	32	0,1625	80	10	pce	26,87
1153579	770134105	3/4 B	52	76	38	0,233	50	10	pce	25,13
1153590	770134205	3/4 G	52	76	38	0,2452	50	10	pce	29,52
1153580	770134106	1 B	60	87	46	0,35	1620	30	pce	34,92
1153591	770134206	1 G	60	87	46	0,366	1620	30	pce	52,69
1153581	770134107	1 1/4 B	73	103	55	0,52	810	15	pce	44,15
1153592	770134207	1 1/4 G	73	103	55	0,54	810	15	pce	67,68
1153582	770134108	1 1/2 B	81	115	62	0,686	540	10	pce	66,59
1153593	770134208	1 1/2 G	81	115	62	0,705	540	10	pce	103,30
1153583	770134109	2 B	97	128	75	1,044	270	5	pce	85,27
1153594	770134209	2 G	97	128	75	1,08	270	5	pce	130,60

GF Malleable Fittings tee 135

- Tee equal
- Male / male / male

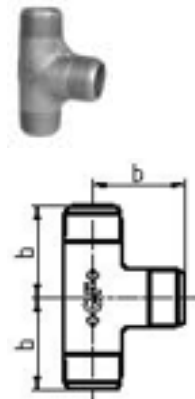

Item No.	Item no. GF	Dimensions	L mm	W mm	H mm	W kg	Pallet/ Pack	Box/M QTY	UOM	Price per m/each
1153598	770135104	1/2 B	48	74	22	0,1348	40	10	pce	21,79
1153601	770135204	1/2 G	48	74	22	0,1402	40	10	pce	33,34
1153599	770135105	3/4 B	57	86	27	0,187	2700	50	pce	31,97
1153602	770135205	3/4 G	57	86	27	0,2212	2700	50	pce	48,40
1153600	770135106	1 B	65	96	34	0,334	1080	15	pce	34,97
1153603	770135206	1 G	65	96	34	0,316	1080	15	pce	53,52

Malleable Fittings

GF Malleable Fittings distribution tee 137

- Distribution Tee reducing on branch
- Female / male / female

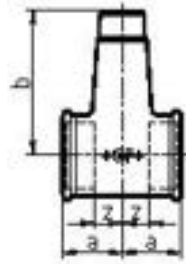

Item No.	Item no. GF	Dimensions	z mm	Pallet/ Pack	Box/M QTY	UOM	Price per m/each
1153604	770137216	1 1/4 - 3/4 G	16	1080	20	pce	93,06
1153605	770137217	1 1/4 - 1 G	16	1080	20	pce	102,62

GF Malleable Fittings tee equal 165 45deg

- Tee 45°, equal
- Female /female /female

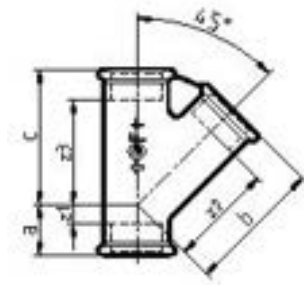

Item No.	Item no. GF	Dimensions	L mm	W mm	H mm	W mm	Pallet/ Pack	Box/M QTY	UOM	Price per m/each
1153607	770165103	3/8 B	54	62	27	0,164	2160	30	pce	24,42
1153608	770165104	1/2 B	63	77	27	0,255	40	10	pce	30,59
1153614	770165204	1/2 G	63	77	32	0,2675	40	10	pce	46,28
1153609	770165105	3/4 B	75	88	32	0,3686	1620	30	pce	35,11
1153615	770165205	3/4 G	75	88	38	0,3833	1620	30	pce	53,05
1153610	770165106	1 B	90	105	38	0,557	1080	20	pce	52,63
1153616	770165206	1 G	90	105	46	0,577	1080	20	pce	79,61
1153611	770165107	1 1/4 B	97	125	46	0,846	540	20	pce	66,60
1153617	770165207	1 1/4 G	97	125	55	0,871	540	20	pce	99,99
1153612	770165108	1 1/2 B	120	132	55	0,992	405	15	pce	91,85
1153618	770165208	1 1/2 G	120	132	62	1,045	405	15	pce	137,91
1153613	770165109	2 B	135	154	62	1,53	216	8	pce	137,26
1153619	770165209	2 G	135	154	75	1,59	216	8	pce	208,64

Malleable Fittings

GF Malleable Fittings cross equal 180

- Cross, equal, ISO/EN C1
- Female/ female/ female/ female

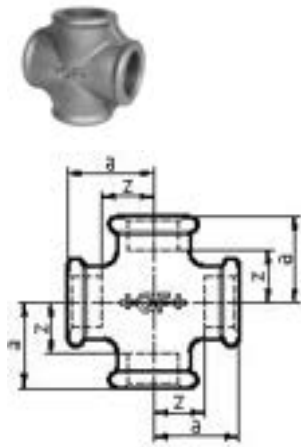

Item No.	Item no. GF	Dimensions	L mm	W mm	H mm	W kg	Pallet/ Pack	Box/M QTY	UOM	Price per m/each
1153620	770180102	1/4 B	42	42	23	0,1003	4320	60	pce	14,83
1153637	770180202	1/4 G	42	42	23	0,104	4320	60	pce	23,82
1153621	770180103	3/8 B	50	50	27	0,1415	4320	80	pce	19,75
1153638	770180203	3/8 G	50	50	27	0,1477	4320	80	pce	32,10
1153622	770180104	1/2 B	56	56	32	0,21	60	10	pce	16,64
1153639	770180204	1/2 G	56	56	32	0,217	60	10	pce	25,88
1153623	770180105	3/4 B	66	66	38	0,305	2160	40	pce	25,01
1153640	770180205	3/4 G	66	66	38	0,314	2160	40	pce	40,83
1153624	770180106	1 B	76	76	46	0,43	1080	20	pce	31,72
1153641	770180206	1 G	76	76	46	0,45	1080	20	pce	51,87
1153625	770180107	1 1/4 B	90	90	55	0,669	810	15	pce	43,42
1153642	770180207	1 1/4 G	90	90	55	0,69	810	15	pce	70,30
1153626	770180108	1 1/2 B	100	100	62	0,841	432	8	pce	55,91
1153643	770180208	1 1/2 G	100	100	62	0,867	432	8	pce	94,66
1153627	770180109	2 B	116	116	75	1,111	270	10	pce	91,21
1153644	770180209	2 G	116	116	75	1,137	270	10	pce	147,12
1153628	770180110	2 1/2 B	138	138	92	2,06	162	3	pce	126,09
1153645	770180210	2 1/2 G	138	138	92	2,067	162	3	pce	207,40
1153629	770180111	3 B	156	156	107	2,42	135	5	pce	167,71
1153646	770180211	3 G	156	156	107	2,49	135	5	pce	263,46
1153630	770180112	4 B	192	192	135	4,07	81	3	pce	293,09
1153647	770180212	4 G	192	192	135	4,2	81	3	pce	454,44

GF Malleable Fittings cross reduced 180

- Cross, reducing, ISO/EN C1
- Female/ female/ female/ female

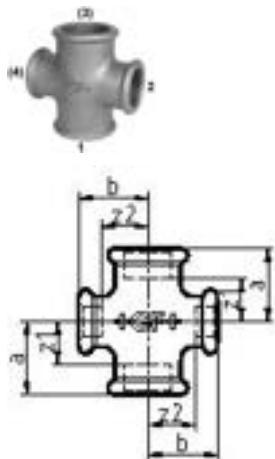

Item No.	Item no. GF	Dimensions	z1 mm	z2 mm	Pallet/ Pack	Box/M QTY	UOM	Price per m/each		
1153632	770180116	1 - 1/2 B	68	64	46	0,264	1620	30	pce	49,77
1153649	770180216	1 - 1/2 G	68	64	46	0,274	1620	30	pce	75,27
1153633	770180117	1 - 3/4 B	72	70	46	0,287	1620	30	pce	49,77
1153650	770180217	1 - 3/4 G	72	70	46	0,297	1620	30	pce	75,27
1153634	770180118	1 1/4 - 1 B	84	80	55	0,541	810	15	pce	60,71
1153651	770180218	1 1/4 - 1 G	84	80	55	0,554	810	15	pce	85,98
1153635	770180120	1 1/2 - 1 B	92	84	62	0,6506	810	15	pce	84,47
1153652	770180220	1 1/2 - 1 G	92	84	62	0,6333	810	15	pce	119,74
1153636	770180121	2 - 1 B	104	88	75	0,828	540	10	pce	95,75
1153653	770180221	2 - 1 G	104	88	75	0,872	540	10	pce	138,39

Malleable Fittings

GF Malleable Fittings Y-piece 220

- Y-piece
- Female/ female/ female

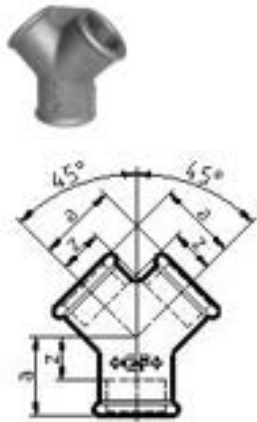

Item No.	Item no. GF	Dimensions	z mm	Pallet/ Pack	Box/M QTY	UOM	Price per m/each
1153654	770220103	3/8 B	14	60	10	pce	23,47
1153658	770220203	3/8 G	52 50 27 0,122	60	10	pce	35,47
1153655	770220104	1/2 B	59 57 32 0,174	80	10	pce	20,63
1153659	770220204	1/2 G	59 57 32 0,179	80	10	pce	31,20
1153656	770220105	3/4 B	71 69 38 0,252	40	10	pce	32,49
1153660	770220205	3/4 G	71 69 38 0,2635	40	10	pce	49,11
1153657	770220106	1 B	86 83 46 0,405	1080	20	pce	46,11
1153661	770220206	1 G	86 83 46 0,417	1080	20	pce	70,59

GF Malleable Fittings side outlet elbow 221

- Side outlet elbow, ISO/EN Za1
- Corner elbow
- Female/ female/ female

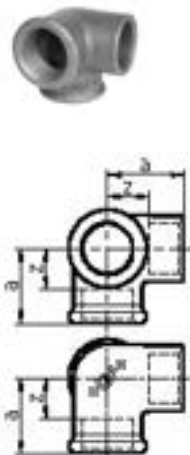

Item No.	Item no. GF	Dimensions	L mm	W mm	H mm	W kg	Pallet/ Pack	Box/M QTY	UOM	Price per m/each
1153662	770221103	3/8 B	39	39	39	0,11	3600	50	pce	20,33
1153669	770221203	3/8 G	39	39	39	0,115	3600	50	pce	30,77
1153663	770221104	1/2 B	44	44	44	0,156	80	10	pce	17,06
1153670	770221204	1/2 G	44	44	44	0,1575	80	10	pce	25,81
1153664	770221105	3/4 B	52	52	52	0,222	50	10	pce	20,40
1153671	770221205	3/4 G	52	52	52	0,2316	50	10	pce	27,47
1153665	770221106	1 B	61	61	61	0,346	1620	30	pce	35,55
1153672	770221206	1 G	61	61	61	0,356	1620	30	pce	53,78
1153666	770221107	1 1/4 B	73	73	73	0,485	810	15	pce	65,58
1153673	770221207	1 1/4 G	73	73	73	0,505	810	15	pce	98,53
1153667	770221108	1 1/2 B	81	81	81	0,62	540	10	pce	95,38
1153674	770221208	1 1/2 G	81	81	81	0,635	540	10	pce	143,22
1153668	770221109	2 B	96	96	96	1,0053	270	5	pce	145,83
1153675	770221209	2 G	96	96	96	1,058	270	5	pce	219,00

Malleable Fittings

GF Malleable Fittings side outlet tee 223

- Side outlet tee, ISO/EN Za2
- Female/ female/ female/ female

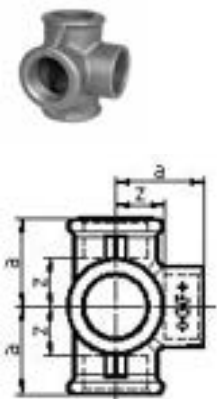

Item No.	Item no. GF	Dimensions	L mm	W mm	H mm	W kg	Pallet/ Pack	Box/M QTY	UOM	Price per m/each
1153676	770223104	1/2 B	44	56	45	0,2101	2160	30	pce	23,00
1153679	770223204	1/2 G	44	56	45	0,22	2160	30	pce	35,21
1153677	770223105	3/4 B	52	66	52	0,297	1080	15	pce	29,05
1153680	770223205	3/4 G	52	66	52	0,3067	1080	15	pce	43,76
1153678	770223106	1 B	61	76	61	0,419	720	10	pce	42,89
1153681	770223206	1 G	61	76	61	0,43	720	10	pce	64,89

GF Malleable Fittings socket reduced 240

- Socket, reducing, ISO/EN M2
- Female/ female

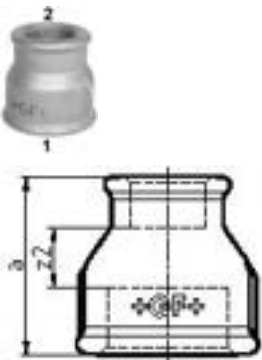

Item No.	Item no. GF	Dimensions	L mm	W mm	H mm	W kg	Pallet/ Pack	Box/M QTY	UOM	Price per m/each
1153682	770240115	1/4 - 1/8 STAB	23	27	23	0,023	100	10	pce	5,53
1153715	770240215	1/4 - 1/8 STAG	23	27	23	0,024	100	10	pce	8,43
1153683	770240116	3/8 - 1/8 STAB	27	30	27	0,034	100	10	pce	7,05
1153716	770240216	3/8 - 1/8 STAG	27	30	27	0,0362	100	10	pce	10,65
1153684	770240117	3/8 - 1/4 STAB	27	30	27	0,038	100	10	pce	5,59
1153717	770240217	3/8 - 1/4 STAG	27	30	27	0,0385	100	10	pce	9,56
1153685	770240118	1/2 - 1/4 B	32	36	32	0,083	180	10	pce	5,34
1153718	770240218	1/2 - 1/4 G	32	36	32	0,088	180	10	pce	9,60
1153686	770240119	1/2 - 3/8 B	32	36	32	0,086	70	10	pce	4,25
1153719	770240219	1/2 - 3/8 G	32	36	32	0,0883	70	10	pce	7,47
1153687	770240120	3/4 - 1/4 B	38	39	38	0,109	50	10	pce	8,29
1153720	770240220	3/4 - 1/4 G	38	39	38	0,114	50	10	pce	13,52
1153688	770240121	3/4 - 3/8 B	38	39	38	0,091	50	10	pce	6,65
1153721	770240221	3/4 - 3/8 G	38	39	38	0,115	50	10	pce	10,83
1153689	770240122	3/4 - 1/2 B	38	39	38	0,116	100	10	pce	5,15
1153722	770240222	3/4 - 1/2 G	38	39	38	0,1212	100	10	pce	8,34
1153690	770240123	1 - 3/8 B	46	45	46	0,164	30	10	pce	11,19
1153723	770240223	1 - 3/8 G	46	45	46	0,168	30	10	pce	17,95
1153691	770240124	1 - 1/2 B	46	45	46	0,173	60	10	pce	6,02
1153724	770240224	1 - 1/2 G	46	45	46	0,171	60	10	pce	10,86
1153692	770240125	1 - 3/4 B	46	45	46	0,189	60	10	pce	6,39
1153725	770240225	1 - 3/4 G	46	45	46	0,198	60	10	pce	10,27

Malleable Fittings

GF Malleable Fittings socket reduced 240

- Malleable cast iron
- Socket reduced
- ISO/EN M2

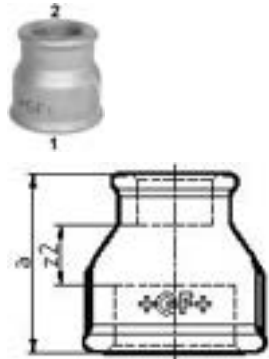

Item No.	Item no. GF	Dimensions	L mm	W mm	H mm	W kg	Pallet/ Pack	Box/M QTY	UOM	Price per m/each
1153693	770240126	1 1/4 - 3/8 B	55	50	55	0,19	1440	20	pce	21,00
1153726	770240226	1 1/4 - 3/8 G	55	50	55	0,194	1440	20	pce	33,48
1153694	770240127	1 1/4 - 1/2 B	55	50	55	0,242	2160	40	pce	11,55
1153727	770240227	1 1/4 - 1/2 G	55	50	55	0,251	2160	40	pce	23,77
1153695	770240128	1 1/4 - 3/4 B	55	50	55	0,253	2160	40	pce	11,83
1153728	770240228	1 1/4 - 3/4 G	55	50	55	0,261	2160	40	pce	23,49
1153696	770240129	1 1/4 - 1 B	55	50	55	0,256	2160	40	pce	11,58
1153729	770240229	1 1/4 - 1 G	55	50	55	0,267	2160	40	pce	18,60
1153697	770240130	1 1/2 - 1/2 B	62	55	62	0,284	2160	40	pce	22,59
1153730	770240230	1 1/2 - 1/2 G	62	55	62	0,292	2160	40	pce	39,98
1153698	770240131	1 1/2 - 3/4 B	62	55	62	0,288	2160	40	pce	19,42
1153731	770240231	1 1/2 - 3/4 G	62	55	62	0,302	2160	40	pce	35,94
1153699	770240132	1 1/2 - 1 B	62	55	62	0,31	1620	30	pce	14,58
1153732	770240232	1 1/2 - 1 G	62	55	62	0,3235	1620	30	pce	26,79
1153700	770240133	1 1/2 - 1 1/4 B	62	55	62	0,332	1620	30	pce	15,09
1153733	770240233	1 1/2 - 1 1/4 G	62	55	62	0,346	1620	30	pce	29,96
1153701	770240134	2 - 1/2 B	75	65	75	0,434	1350	25	pce	30,51
1153702	770240135	2 - 3/4 B	75	65	75	0,448	1350	25	pce	32,49
1153735	770240235	2 - 3/4 G	75	65	75	0,4624	1350	25	pce	57,39
1153703	770240136	2 - 1 B	75	65	75	0,462	1080	20	pce	28,18
1153736	770240236	2 - 1 G	75	65	75	0,4768	1080	20	pce	51,90
1153704	770240137	2 - 1 1/4 B	75	65	75	0,497	810	15	pce	26,24

Malleable Fittings

GF Malleable Fittings socket reduced 240

- 'ST' - these types of fittings are made from steel (galvanised finish = electroplated)
- Not suitable for drinking water installations.
- Steel parts are hexagonal instead of beaded at the end no. 1.

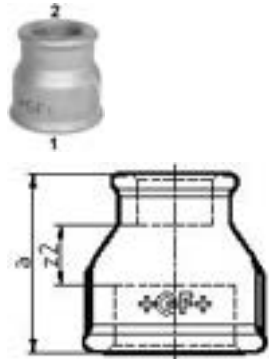

Item No.	Item no. GF	Dimensions	L mm	W mm	H mm	W kg	Pallet/ Pack	Box/M QTY	UOM	Price per m/each
1153737	770240237	2 - 1 1/4 G	75	65	75	0,512	810	15	pce	48,41
1153705	770240138	2 - 1 1/2 B	75	65	75	0,505	810	15	pce	21,15
1153738	770240238	2 - 1 1/2 G	75	65	75	0,53	810	15	pce	38,46
1153706	770240139	2 1/2 - 1 B	92	74	92	0,668	810	15	pce	59,89
1153739	770240239	2 1/2 - 1 G	92	74	92	0,61	810	15	pce	110,85
1153707	770240141	2 1/2 - 1 1/2 B	92	74	92	0,71	540	10	pce	51,46
1153740	770240241	2 1/2 - 1 1/2 G	92	74	92	0,731	540	10	pce	85,69
1153708	770240142	2 1/2 - 2 B	92	74	92	0,795	540	10	pce	44,40
1153741	770240242	2 1/2 - 2 G	92	74	92	0,818	540	10	pce	82,37
1153709	770240143	3 - 1 1/2 B	107	80	107	0,922	540	20	pce	74,05
1153742	770240243	3 - 1 1/2 G	107	80	107	0,95	540	20	pce	118,96
1153710	770240144	3 - 2 B	107	80	107	0,866	540	10	pce	68,70
1153743	770240244	3 - 2 G	107	80	107	0,894	540	10	pce	102,90
1153711	770240145	3 - 2 1/2 B	107	80	107	1,03	405	15	pce	78,66
1153744	770240245	3 - 2 1/2 G	107	80	107	1,13	405	15	pce	106,47
1153712	770240146	4 - 2 B	135	94	135	1,607	270	10	pce	136,49
1153745	770240246	4 - 2 G	135	94	135	1,659	270	10	pce	204,84
1153713	770240147	4 - 2 1/2 B	135	94	135	1,4583	216	4	pce	127,79
1153746	770240247	4 - 2 1/2 G	135	94	135	1,385	216	4	pce	187,70
1153714	770240148	4 - 3 B	135	94	135	1,58	216	4	pce	127,79
1153747	770240248	4 - 3 G	135	94	135	1,6044	216	4	pce	191,84

Malleable Fittings

GF Malleable Fittings reducing bush 241 N4

- Reducing bush, ISO/EN N4
- Forms I, II, III are available only as marked under column "Form"
- Form I can also be supplied with continuous internal thread (=241D).
- 'ST' these types of fittings are made from steel (galvanised finish = electroplated)
- Not suitable for drinking water installations.

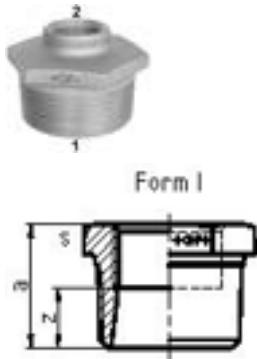

Item No.	Item no. GF	Dimensions	L mm	W mm	H mm	W kg	Pallet/ Pack	Box/M QTY	UOM	Price per m/each
1153760	770241115	1/4 - 1/8 STAB	20	20	17	0,015	100	10	pce	3,91
1153799	770241215	1/4 - 1/8 STAG	20	20	17	0,0155	100	10	pce	5,97
1153761	770241116	3/8 - 1/8 STAB	22	20	19	0,0265	100	10	pce	4,73
1153800	770241216	3/8 - 1/8 STAG	22	20	19	0,0268	100	10	pce	6,46
1153762	770241117	3/8 - 1/4 STAB	22	20	19	0,018	100	10	pce	3,43
1153801	770241217	3/8 - 1/4 STAG	22	20	19	0,0185	100	10	pce	5,21
1153763	770241118	1/2 - 1/8 B	27	24	23	0,039	150	10	pce	3,77
1153802	770241218	1/2 - 1/8 G	27	24	23	0,0408	150	10	pce	5,73
1153764	770241119	1/2 - 1/4 B	27	24	23	0,0381	150	10	pce	2,54
1153803	770241219	1/2 - 1/4 G	27	24	23	0,0396	150	10	pce	3,48
1153765	770241120	1/2 - 3/8 B	27	24	23	0,0316	300	10	pce	2,54
1153804	770241220	1/2 - 3/8 G	27	24	23	0,0326	300	10	pce	3,89
1153766	770241121	3/4 - 1/4 B	35	26	30	0,0746	80	10	pce	4,82
1153805	770241221	3/4 - 1/4 G	35	26	30	0,0765	80	10	pce	7,31
1153767	770241122	3/4 - 3/8 B	35	27	30	0,0682	200	10	pce	3,81
1153806	770241222	3/4 - 3/8 G	35	27	30	0,069	200	10	pce	5,73
1153768	770241123	3/4 - 1/2 B	35	26	30	0,058	200	10	pce	2,92
1153807	770241223	3/4 - 1/2 G	35	26	30	0,06	200	10	pce	4,44
1153769	770241124	1 - 1/4 B	42	29	36	0,1304	100	10	pce	6,39
1153808	770241224	1 - 1/4 G	42	29	36	0,1318	100	10	pce	10,45
1153770	770241125	1 - 3/8 B	42	29	36	0,1099	100	10	pce	6,32
1153809	770241225	1 - 3/8 G	42	29	36	0,11	100	10	pce	10,82
1153771	770241126	1 - 1/2 B	42	29	36	0,115	120	10	pce	3,53
1153810	770241226	1 - 1/2 G	42	29	36	0,115	120	10	pce	6,03
1153772	770241127	1 - 3/4 B	42	29	36	0,0905	120	10	pce	3,75
1153811	770241227	1 - 3/4 G	42	29	36	0,0938	120	10	pce	5,70
1153777	770241132	1 1/2 - 3/8 B	58	31	50	0,21	2880	80	pce	16,74

Malleable Fittings

GF Malleable Fittings reducing bush 241 N4

- Malleable cast iron
- Reducing bush
- ISO/EN N4



Item No.	Item no. GF	Dimensions	L mm	W mm	H mm	W kg	Pallet/ Pack	Box/M QTY	UOM	Price per m/each
1153816	770241232	1 1/2 - 3/8 G	58	31	50	0,245	2880	80	pce	25,46
1153778	770241133	1 1/2 - 1/2 B	58	31	50	0,236	2160	60	pce	9,29
1153817	770241233	1 1/2 - 1/2 G	58	31	50	0,227	2160	60	pce	15,08
1153779	770241134	1 1/2 - 3/4 B	58	31	50	0,214	2880	80	pce	10,05
1153818	770241234	1 1/2 - 3/4 G	58	31	50	0,221	2880	80	pce	16,32
1153780	770241135	1 1/2 - 1 B	58	31	50	0,212	3240	60	pce	7,30
1153819	770241235	1 1/2 - 1 G	58	31	50	0,2075	3240	60	pce	10,70
1153781	770241136	1 1/2 - 1 1/4 B	58	33	50	0,136	3240	60	pce	6,68
1153820	770241236	G 1 1/2 - 1 1/4	58	33	50	0,136	3240	60	pce	11,31
1153773	770241128	1 1/4 - 3/8 B	53	31	46	0,199	2880	40	pce	13,11
1153812	770241228	1 1/4 - 3/8 G	53	31	46	0,208	2880	40	pce	19,81
1153774	770241129	1 1/4 - 1/2 B	53	31	46	0,197	2880	80	pce	7,22
1153813	770241229	1 1/4 - 1/2 G	53	31	46	0,205	2880	80	pce	11,85
1153775	770241130	1 1/4 - 3/4 B	53	31	46	0,176	2880	80	pce	6,54
1153814	770241230	1 1/4 - 3/4 G	53	31	46	0,182	2880	80	pce	10,64
1153776	770241131	1 1/4 - 1 B	53	31	46	0,141	4320	80	pce	4,62
1153815	770241231	1 1/4 - 1 G	53	31	46	0,146	4320	80	pce	7,14
1153782	770241137	2 - 1/2 B	75	48	65	0,464	1620	30	pce	19,10
1153821	770241237	2 - 1/2 G	75	48	65	0,4693	1620	30	pce	31,02
1153783	770241138	2 - 3/4 B	75	48	65	0,42	1620	30	pce	20,00
1153784	770241139	2 - 1 B	75	37	65	0,426	1620	30	pce	15,09
1153822	770241238	2 - 3/4 G	75	48	65	0,432	1620	30	pce	30,33
1153823	770241239	2 - 1 G	75	37	65	0,438	1620	30	pce	22,68
1153785	770241140	2 - 1 1/4 B	75	37	65	0,3636	1620	30	pce	14,59
1153824	770241240	2 - 1 1/4 G	75	37	65	0,3743	1620	30	pce	23,70
1153786	770241141	2 - 1 1/2 B	75	37	65	0,3	1620	30	pce	13,96
1153825	770241241	2 - 1 1/2 G	75	37	65	0,309	1620	30	pce	21,18

Malleable Fittings

GF Malleable Fittings reducing bush 241 N4

- Forms I, II, III are available only as marked under column "Form"
- Form I can also be supplied with continuous internal thread (=241D).
- 'ST' these types of fittings are made from steel (galvanised finish = electroplated)
- Not suitable for drinking water installations.



Item No.	Item no. GF	Dimensions	L mm	W mm	H mm	W kg	Pallet/ Pack	Box/M QTY	UOM	Price per m/each
1153787	770241142	2 1/2 - 1 B	92	54	80	0,6605	810	15	pce	33,56
1153826	770241242	2 1/2 - 1 G	92	54	80	0,669	810	15	pce	52,95
1153788	770241143	2 1/2 - 1 1/4 B	92	54	80	0,624	810	15	pce	33,56
1153827	770241243	2 1/2 - 1 1/4 G	92	54	80	0,64	810	15	pce	52,95
1153789	770241144	2 1/2 - 1 1/2 B	92	40	80	0,65	1080	20	pce	32,11
1153828	770241244	2 1/2 - 1 1/2 G	92	40	80	0,665	1080	20	pce	52,95
1153790	770241145	2 1/2 - 2 B	92	40	80	0,491	1080	20	pce	23,36
1153829	770241245	2 1/2 - 2 G	92	40	80	0,504	1080	20	pce	39,13
1153793	770241148	3 - 1 1/2 B	109	59	95	0,9086	540	10	pce	55,31
1153832	770241248	3 - 1 1/2 G	109	59	95	0,88	540	10	pce	87,30
1153792	770241147	3 - 1 1/4 B	109	59	95	0,915	540	10	pce	55,31
1153831	770241247	3 - 1 1/4 G	109	59	95	0,94	540	10	pce	87,30
1153791	770241146	3 - 1 B	109	59	95	0,955	540	10	pce	56,88
1153830	770241246	3 - 1 G	109	59	95	0,968	540	10	pce	89,82
1153795	770241150	3 - 2 1/2 B	110	44	96	0,592	540	10	pce	42,08
1153834	770241250	3 - 2 1/2 G	110	44	96	0,609	540	10	pce	68,82
1153794	770241149	3 - 2 B	109	44	95	0,895	540	10	pce	37,89
1153833	770241249	3 - 2 G	109	44	95	0,915	540	10	pce	70,15
1153796	770241151	4 - 2 B	138	69	120	1,591	324	6	pce	103,63
1153835	770241251	4 - 2 G	138	69	120	1,586	324	6	pce	163,65
1153797	770241152	4 - 2 1/2 B	138	69	120	1,595	324	6	pce	103,63
1153836	770241252	4 - 2 1/2 G	138	69	120	1,652	324	6	pce	163,65
1153798	770241153	4 - 3 B	138	53	120	1,446	324	6	pce	86,26
1153837	770241253	4 - 3 G	138	53	120	1,48	324	6	pce	136,18

Malleable Fittings

GF Malleable Fittings hexagonal nipple reduced 245

- Hexagon nipple, reducing, ISO/EN N8
- 'ST' these types of fittings are made from steel (galvanised finish = electroplated)
- Not suitable for drinking water installations.

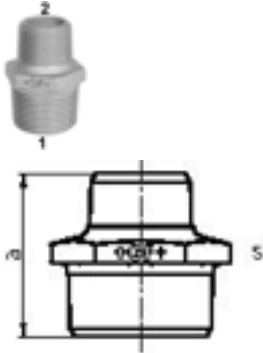

Item No.	Item no. GF	Dimensions	L mm	W mm	H mm	W kg	Pallet/ Pack	Box/M QTY	UOM	Price per m/each
1153865	770245115	1/4 - 1/8 STAB	20	35	17	0,0255	100	10	pce	5,57
1153889	770245215	1/4 - 1/8 STAG	20	35	17	0,0262	100	10	pce	9,02
1153866	770245116	3/8 - 1/8 STAB	22	34	19	0,0315	100	10	pce	7,98
1153890	770245216	3/8 - 1/8 STAG	22	34	19	0,0316	100	10	pce	12,72
1153867	770245117	3/8 - 1/4 STAB	22	38	19	0,0348	100	10	pce	5,57
1153891	770245217	3/8 - 1/4 STAG	22	38	19	0,0354	100	10	pce	9,02
1153868	770245118	1/2 - 1/4 B	31	44	27	0,0498	100	10	pce	7,16
1153892	770245218	1/2 - 1/4 G	31	44	27	0,052	100	10	pce	12,40
1153869	770245119	1/2 - 3/8 B	25	44	22	0,054	100	10	pce	6,40
1153893	770245219	1/2 - 3/8 G	25	44	22	0,056	100	10	pce	11,11
1153870	770245120	3/4 - 1/4 B	34	43	30	0,087	80	10	pce	18,02
1153894	770245220	3/4 - 1/4 G	34	43	30	0,0907	80	10	pce	28,87
1153871	770245121	3/4 - 3/8 B	34	47	30	0,0853	50	10	pce	12,72
1153895	770245221	3/4 - 3/8 G	34	47	30	0,0897	50	10	pce	20,84
1153872	770245122	3/4 - 1/2 B	35	47	31	0,095	120	10	pce	5,89
1153896	770245222	3/4 - 1/2 G	35	47	31	0,0985	120	10	pce	9,46
1153873	770245123	1 - 1/2 B	41	53	36	0,1512	80	10	pce	10,94
1153897	770245223	1 - 1/2 G	41	53	36	0,1555	80	10	pce	17,62
1153874	770245124	1 - 3/4 B	41	53	36	0,159	80	10	pce	5,89
1153898	770245224	1 - 3/4 G	41	53	36	0,1622	80	10	pce	10,15
1153875	770245125	1 1/4 - 1/2 B	53	57	46	0,228	1800	25	pce	19,79
1153899	770245225	1 1/4 - 1/2 G	53	57	46	0,2344	1800	25	pce	31,66

Malleable Fittings

GF Malleable Fittings hexagonal nipple reduced 245

- 'ST' these types of fittings are made from steel (galvanised finish = electroplated)
- Not suitable for drinking water installations.

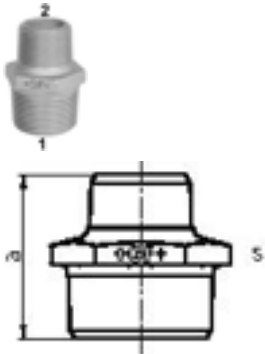

Item No.	Item no. GF	Dimensions	L mm	W mm	H mm	W kg	Pallet/ Pack	Box/M QTY	UOM	Price per m/each
1153876	770245126	1 1/4 - 3/4 B	53	57	46	0,23	3240	60	pce	17,89
1153900	770245226	1 1/4 - 3/4 G	53	57	46	0,235	3240	60	pce	28,95
1153877	770245127	1 1/4 - 1 B	53	57	46	0,236	2700	50	pce	11,09
1153901	770245227	1 1/4 - 1 G	53	57	46	0,246	2700	50	pce	17,83
1153878	770245128	1 1/2 - 3/4 B	58	59	50	0,292	1440	20	pce	22,32
1153902	770245228	1 1/2 - 3/4 G	58	59	50	0,301	1440	20	pce	36,46
1153879	770245129	1 1/2 - 1 B	58	59	50	0,28	2160	40	pce	26,29
1153903	770245229	1 1/2 - 1 G	58	59	50	0,287	2160	40	pce	42,57
1153880	770245130	1 1/2 1 - 1/4 B	58	59	50	0,282	2160	40	pce	14,03
1153904	770245230	1 1/2 1 - 1/4 G	58	59	50	0,29	2160	40	pce	23,60
1153881	770245131	2 - 1 B	73	68	65	0,5075	1350	25	pce	26,82
1153905	770245231	2 - 1 G	73	68	65	0,5194	1350	25	pce	39,81
1153882	770245132	2 - 1 1/4 B	73	68	65	0,396	1080	20	pce	33,58
1153906	770245232	2 - 1 1/4 G	73	68	65	0,418	1080	20	pce	54,42
1153883	770245133	2 - 1 1/2 B	73	68	65	0,53	1080	20	pce	26,75
1153907	770245233	2 - 1 1/2 G	73	68	65	0,55	1080	20	pce	45,02
1153884	770245134	2 1/2 - 1 1/2 B	92	75	80	0,72	540	10	pce	44,75
1153908	770245234	2 1/2 - 1 1/2 G	92	75	80	0,774	540	10	pce	67,24
1153885	770245135	2 1/2 - 2 B	92	75	80	0,726	540	10	pce	45,36
1153909	770245235	2 1/2 - 2 G	92	75	80	0,728	540	10	pce	70,31
1153887	770245137	3 - 2 1/2 B	108	83	95	1,047	432	8	pce	81,15
1153911	770245237	3 - 2 1/2 G	108	83	95	1,091	432	8	pce	126,93
1153886	770245136	3 - 2 B	108	83	95	1,0704	432	8	pce	60,86
1153910	770245236	3 - 2 G	108	83	95	1,0956	432	8	pce	95,20
1153888	770245138	4 - 3 B	137	93	119	1,8208	324	12	pce	265,22
1153912	770245238	4 - 3 G	137	93	119	1,88	324	12	pce	406,51

Malleable Fittings

GF Malleable Fittings socket reduced 246

- Socket, reducing, ISO/EN M4
- 'ST' these types of fittings are made from steel (galvanised finish = electroplated)
- Not suitable for drinking water installations
- Steel parts are hexagonal instead of beaded at the end no. 1.

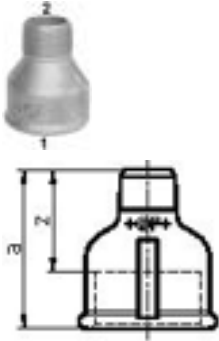

Item No.	Item no. GF	Dimensions	L mm	W mm	H mm	W kg	Pallet/ Pack	Box/M QTY	UOM	Price per m/each
1153923	770246115	1/4 - 1/8 STAB	23	32	23	0,0265	100	10	pce	6,77
1153924	770246116	3/8 - 1/4 STAB	27	35	27	0,045	100	10	pce	5,62
1153945	770246216	3/8 - 1/4 STAG	27	35	27	0,046	100	10	pce	8,50
1153925	770246117	1/2 - 1/4 B	32	43	32	0,061	80	10	pce	7,72
1153946	770246217	1/2 - 1/4 G	32	43	32	0,0635	80	10	pce	11,87
1153926	770246118	1/2 - 3/8 B	32	43	32	0,085	80	10	pce	6,16
1153947	770246218	1/2 - 3/8 G	32	43	32	0,088	80	10	pce	9,36
1153927	770246119	3/4 - 3/8 B	38	48	38	0,107	50	10	pce	9,86
1153948	770246219	3/4 - 3/8 G	38	48	38	0,112	50	10	pce	14,92
1153928	770246120	3/4 - 1/2 B	38	48	38	0,113	100	10	pce	5,70
1153949	770246220	3/4 - 1/2 G	38	48	38	0,118	100	10	pce	8,60
1153929	770246121	1 - 1/2 B	46	55	46	0,1813	30	10	pce	10,68
1153950	770246221	1 - 1/2 G	46	55	46	0,188	30	10	pce	16,14
1153930	770246122	1 - 3/4 B	46	55	46	0,169	60	10	pce	9,06
1153951	770246222	1 - 3/4 G	46	55	46	0,1743	60	10	pce	13,74
1153931	770246123	1 1/4 - 1/2 B	55	60	55	0,239	1440	20	pce	28,31
1153952	770246223	1 1/4 - 1/2 G	55	60	55	0,247	1440	20	pce	43,30
1153932	770246124	1 1/4 - 3/4 B	55	60	55	0,2448	2700	50	pce	22,07
1153953	770246224	1 1/4 - 3/4 G	55	60	55	0,252	2700	50	pce	33,15
1153933	770246125	1 1/4 - 1 B	55	60	55	0,237	2700	50	pce	12,32
1153954	770246225	1 1/4 - 1 G	55	60	55	0,251	2700	50	pce	20,74
1153934	770246126	1 1/2 - 3/4 B	62	60	62	0,267	2160	40	pce	26,54

Malleable Fittings

GF Malleable Fittings socket reduced 246

- 'ST' these types of fittings are made from steel (galvanised finish = electroplated)
- Not suitable for drinking water installations.
- Steel parts are hexagonal instead of beaded at the end no. 1.

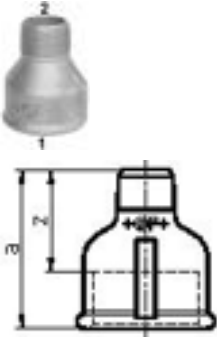

Item No.	Item no. GF	Dimensions	L mm	W mm	H mm	W kg	Pallet/ Pack	Box/M QTY	UOM	Price per m/each
1153955	770246226	1 1/2 - 3/4 G	62	60	62	0,276	2160	40	pce	40,62
1153935	770246127	1 1/2 - 1 B	62	63	62	0,288	2160	40	pce	29,25
1153956	770246227	1 1/2 - 1 G	62	63	62	0,295	2160	40	pce	43,96
1153936	770246128	1 1/2 - 1 1/4 B	62	63	62	0,302	1620	30	pce	22,93
1153957	770246228	1 1/2 - 1 1/4 G	62	63	62	0,312	1620	30	pce	39,12
1153937	770246129	2 - 1 B	75	70	75	0,435	720	10	pce	38,33
1153958	770246229	2 - 1 G	75	70	75	0,449	720	10	pce	58,71
1153938	770246130	2 - 1 1/4 B	75	70	75	0,437	1080	20	pce	41,36
1153959	770246230	2 - 1 1/4 G	75	70	75	0,45	1080	20	pce	62,91
1153939	770246131	2 - 1 1/2 B	75	70	75	0,455	1080	20	pce	42,90
1153960	770246231	2 - 1 1/2 G	75	70	75	0,469	1080	20	pce	64,40
1153940	770246132	2 1/2 - 1 1/2 B	92	83	92	0,76	648	12	pce	82,15
1153961	770246232	2 1/2 - 1 1/2 G	92	83	92	0,792	648	12	pce	127,45
1153941	770246133	2 1/2 - 2 B	92	80	92	0,703	648	12	pce	55,04
1153962	770246233	2 1/2 - 2 G	92	80	92	0,716	648	12	pce	84,31
1153942	770246134	3 - 2 B	107	87	107	0,932	648	12	pce	102,85
1153963	770246234	3 - 2 G	107	87	107	0,96	648	12	pce	176,37
1153943	770246135	3 - 2 1/2 B	107	91	107	0,873	648	12	pce	117,64
1153964	770246235	3 - 2 1/2 G	107	91	107	1,0567	648	12	pce	182,39

GF Malleable Fittings socket eccentric reduced 260

- Socket eccentric, reducing

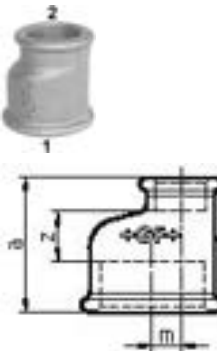

Item No.	Item no. GF	Dimensions	z mm	Pallet/ Pack	Box/M QTY	UOM	Price per m/each
1153978	770260122	3/4 - 1/2 B	13	30	10	pce	9,14
1153971	770260115	1 - 1/2 B	15	30	10	pce	26,21
1153986	770260215	1 - 1/2 G	15	30	10	pce	61,50
1153972	770260116	1 - 3/4 B	13	30	10	pce	29,76
1153973	770260117	1 1/4 - 1/2 B	18	2160	40	pce	38,37
1153988	770260217	1 1/4 - 1/2 G	55 50 55	2160	40	pce	81,27
1153974	770260118	1 1/4 - 3/4 B	16	2160	40	pce	39,01
1153975	770260119	1 1/4 - 1 B	14	1620	30	pce	36,23
1153976	770260120	1 1/2 - 1/2 B	24	2160	40	pce	53,59
1153979	770260123	1 1/2 - 3/4 B	22	1890	35	pce	29,56
1153977	770260121	1 1/2 - 1 B	20	1620	30	pce	44,61
1153980	770260124	1 1/2 - 1 1/4 B	18	1260	35	pce	22,37
1153981	770260125	2 - 1/2 B	28	900	25	pce	28,92
1153982	770260127	2 - 1 B	75 65 75	1080	20	pce	28,92
1153997	770260227	2 - 1 G	24	1080	20	pce	61,97
1153983	770260128	2 - 1 1/4 B	22	1080	20	pce	28,92
1153984	770260129	2 - 1 1/2 B	75 65 75	810	15	pce	26,88
1153985	770260130	2 - 1/2 2 B	23	540	10	pce	54,55

Malleable Fittings

GF Malleable Fittings socket 270

- Socket, ISO/EN M2
- 'ST' these types of fittings are made from steel (galvanised finish = electroplated)
- Not suitable for drinking water installations.
- Steel parts are hexagonal instead of beaded.

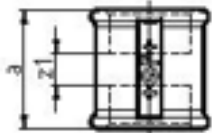

Item No.	Item no. GF	Dimensions	z1 mm			Pallet/ Pack	Box/M QTY	UOM	Price per m/each	
1154005	770270101	1/8 STAB	19	25	19	0,0238	100	10	pce	3,92
1154017	770270201	1/8 STAG	19	25	19	0,0242	100	10	pce	6,03
1154006	770270102	1/4 STAB	23	27	23	0,03	100	10	pce	3,46
1154018	770270202	1/4 STAG	23	27	23	0,0305	100	10	pce	5,23
1154007	770270103	3/8 B	27	30	27	0,0635	100	10	pce	3,46
1154019	770270203	3/8 G	27	30	27	0,0665	100	10	pce	5,25
1154008	770270104	1/2 B	32	36	32	0,1015	120	10	pce	3,21
1154020	770270204	1/2 G	32	36	32	0,109	120	10	pce	4,87
1154009	770270105	3/4 B	38	39	38	0,11	80	10	pce	3,91
1154021	770270205	3/4 G	38	39	38	0,1182	80	10	pce	6,40
1154010	770270106	1 B	46	45	46	0,181	50	10	pce	5,42
1154022	770270206	1 G	46	45	46	0,188	50	10	pce	8,20
1154011	770270107	1 1/4 B	55	50	55	0,287	2160	40	pce	10,47
1154023	770270207	1 1/4 G	55	50	55	0,296	2160	40	pce	17,05
1154012	770270108	1 1/2 B	62	55	62	0,3602	1350	25	pce	15,24
1154024	770270208	1 1/2 G	62	55	62	0,3718	1350	25	pce	22,93
1154013	770270109	2 B	75	65	75	0,57	648	12	pce	22,05
1154025	770270209	2 G	75	65	75	0,587	648	12	pce	33,16
1154014	770270110	2 1/2 B	92	74	92	0,873	540	10	pce	39,99
1154026	770270210	2 1/2 G	92	74	92	0,9	540	10	pce	68,26
1154015	770270111	3 B	107	80	107	1,123	324	12	pce	61,27
1154027	770270211	3 G	107	80	107	1,176	324	12	pce	96,72
1154016	770270112	4 B	135	94	135	1,907	108	4	pce	109,12
1154028	770270212	4 G	135	94	135	1,97	108	4	pce	159,59

GF Malleable Fittings socket 271

- Socket, right and left hand thread, ISO/EN M2 R-L
- 'RT' right hand thread, 'LT' left hand thread

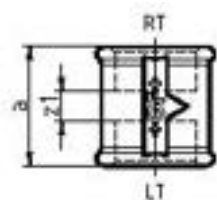

Item No.	Item no. GF	Dimensions	L mm	W mm	H mm	W kg	Pallet/ Pack	Box/M QTY	UOM	Price per m/each
1154040	770271103	3/8 B	27	30	27	0,0645	100	10	pce	6,84
1154047	770271203	3/8 G	27	30	27	0,0672	100	10	pce	10,37
1154041	770271104	1/2 B	32	36	32	0,102	60	10	pce	6,14
1154048	770271204	1/2 G	32	36	32	0,105	60	10	pce	9,35
1154042	770271105	3/4 B	38	39	38	0,115	80	10	pce	8,76
1154049	770271205	3/4 G	38	39	38	0,12	80	10	pce	13,22
1154043	770271106	1 B	46	45	46	0,183	60	10	pce	10,67
1154050	770271206	1 G	46	45	46	0,19	60	10	pce	16,13
1154044	770271107	1 1/4 B	55	50	55	0,2768	2700	50	pce	22,69
1154051	770271207	1 1/4 G	55	50	55	0,289	2700	50	pce	34,10
1154045	770271108	1 1/2 B	62	55	62	0,3533	1620	30	pce	25,24
1154052	770271208	1 1/2 G	62	55	62	0,3646	1620	30	pce	37,90
1154046	770271109	2 B	75	65	75	0,394	810	15	pce	45,91
1154053	770271209	2 G	75	65	75	0,568	810	15	pce	68,95

Malleable Fittings

GF Malleable Fittings hexagonal nipple 280

- Hexagon nipple, ISO/EN N8
- 'ST' these types of fittings are made from steel (galvanised finish = electroplated)
- Not suitable for drinking water installations.

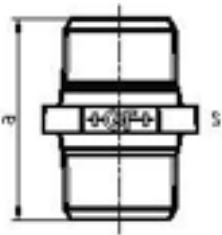

Item No.	Item no. GF	Dimensions	L mm	W mm	H mm	W kg	Pallet/ Pack	Box/M QTY	UOM	Price per m/each
1154054	770280101	1/8 STAB	20	29	17	0,0188	100	10	pce	5,18
1154066	770280201	1/8 STAG	20	29	17	0,019	100	10	pce	8,32
1154055	770280102	1/4 STAB	22	36	19	0,0295	100	10	pce	4,62
1154067	770280202	1/4 STAG	22	36	19	0,0298	100	10	pce	7,52
1154056	770280103	3/8 B	25	38	22	0,0432	100	10	pce	5,42
1154068	770280203	3/8 G	25	38	22	0,0448	100	10	pce	9,34
1154057	770280104	1/2 B	32	44	28	0,076	150	10	pce	3,09
1154069	770280204	1/2 G	32	44	28	0,0778	150	10	pce	5,04
1154058	770280105	3/4 B	37	47	33	0,114	100	10	pce	3,53
1154070	770280205	3/4 G	37	47	33	0,118	100	10	pce	5,72
1154059	770280106	1 B	48	53	42	0,1801	60	10	pce	5,03
1154071	770280206	1 G	48	53	42	0,1883	60	10	pce	8,04
1154060	770280107	1 1/4 B	58	57	50	0,273	2160	40	pce	9,97
1154072	770280207	1 1/4 G	58	57	50	0,281	2160	40	pce	16,02
1154061	770280108	1 1/2 B	63	59	55	0,3251	1620	30	pce	11,58
1154073	770280208	1 1/2 G	63	59	55	0,3342	1620	30	pce	18,42
1154062	770280109	2 B	81	68	70	0,58	810	15	pce	20,94
1154074	770280209	2 G	81	68	70	0,586	810	15	pce	33,63
1154063	770280110	2 1/2 B	99	75	85	0,8	540	20	pce	40,42
1154075	770280210	2 1/2 G	99	75	85	0,835	540	20	pce	57,28
1154064	770280111	3 B	117	83	100	1,108	405	15	pce	58,44
1154076	770280211	3 G	117	83	100	1,141	405	15	pce	93,64
1154065	770280112	4 B	152	95	131	1,87	162	6	pce	107,17
1154077	770280212	4 G	152	95	131	1,9	162	6	pce	166,10

GF Malleable Fittings hexagonal nipple 281

- Hexagon nipple, right and left hand thread, ISO/EN NB R-L
- 'RT' right hand thread, 'LT' left hand thread

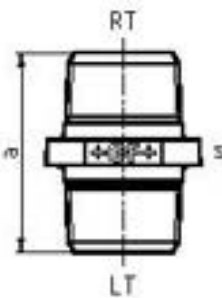

Item No.	Item no. GF	Dimensions	L mm	W mm	H mm	W kg	Pallet/ Pack	Box/M QTY	UOM	Price per m/each
1154093	770281203	3/8 G	24	38	22	0,044	100	10	pce	21,86
1154087	770281104	1/2 B	32	44	28	0,071	80	10	pce	6,84
1154094	770281204	1/2 G	32	44	28	0,0758	80	10	pce	10,38
1154088	770281105	3/4 B	37	47	33	0,1115	100	10	pce	8,51
1154095	770281205	3/4 G	37	47	33	0,115	100	10	pce	12,92
1154089	770281106	1 B	48	53	42	0,181	60	10	pce	14,71
1154096	770281206	1 G	48	53	42	0,1871	60	10	pce	22,20
1154091	770281108	1 1/2 B	63	59	55	0,3188	1620	30	pce	26,70
1154098	770281208	1 1/2 G	63	59	55	0,3288	1620	30	pce	40,11
1154090	770281107	1 1/4 B	58	57	50	0,267	2700	50	pce	22,69
1154097	770281207	1 1/4 G	58	57	50	0,2745	2700	50	pce	34,10
1154092	770281109	2 B	82	68	70	0,52	810	15	pce	50,48
1154099	770281209	2 G	82	68	70	0,535	810	15	pce	75,78

Malleable Fittings

GF Malleable Fittings plug beaded 290

- Plug, beaded, ISO/EN T9
- 'ST' these types of fittings are made from steel (galvanised finish = electroplated)
- Not suitable for drinking water installations.
- * Solid

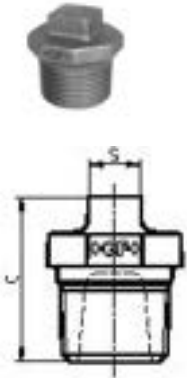

Item No.	Item no. GF	Dimensions	s mm	Pallet/ Pack	Box/M QTY	UOM	Price per m/each
1154100	770290101	1/8 STAB	10 20 7 0,0112	100	10	pce	4,26
1154101	770290102	1/4 STAB	12 24 8 0,022	100	10	pce	2,61
1154113	770290202	1/4 STAG	12 24 8 0,0224	100	10	pce	4,06
1154102	770290103	3/8 B	24 28 22 0,0418	150	10	pce	2,40
1154114	770290203	3/8 G	24 28 22 0,0432	150	10	pce	3,66
1154103	770290104	1/2 B	29 32 27 0,066	200	10	pce	3,21
1154115	770290204	1/2 G	29 32 27 0,0689	200	10	pce	4,89
1154104	770290105	3/4 B	34 37 32 0,106	150	10	pce	3,70
1154116	770290205	3/4 G	34 37 32 0,1085	150	10	pce	5,26
1154105	770290106	1 B	43 41 40 0,154	80	10	pce	4,74
1154117	770290206	1 G	43 41 40 0,157	80	10	pce	7,36
1154106	770290107	1 1/4 B	49 47 45 0,2319	2520	70	pce	8,19
1154118	770290207	1 1/4 G	49 47 45 0,2351	2520	70	pce	12,50
1154107	770290108	1 1/2 B	60 47 55 0,322	1800	50	pce	10,14
1154119	770290208	1 1/2 G	60 47 55 0,326	1800	50	pce	15,51
1154108	770290109	2 B	70 54 65 0,492	1080	30	pce	17,50
1154120	770290209	2 G	70 54 65 0,5	1080	30	pce	31,66
1154109	770290110	2 1/2 B	86 64 80 0,77	810	15	pce	41,10
1154121	770290210	2 1/2 G	86 64 80 0,766	810	15	pce	63,68
1154110	770290111	3 B	103 71 95 1,2	432	8	pce	53,30
1154122	770290211	3 V	36	432	8	pce	82,67
1154111	770290112	4 B	130 81 120 2,04	216	6	pce	93,92
1154123	770290212	4 G	130 81 120 2,09	216	6	pce	145,63

Malleable Fittings

GF Malleable Fittings plug plain 291

- Plug, plain, ISO/EN TB
- 'ST' these types of fittings are made from steel (galvanised finish = electroplated)
- Not suitable for drinking water installations
- Steel parts are made solid.

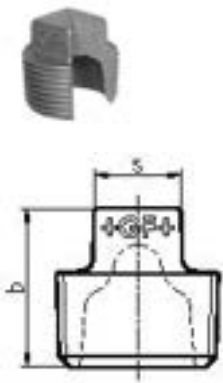

Item No.	Item no. GF	Dimensions	L mm	W mm	H mm	W kg	Pallet/ Pack	Box/M QTY	UOM	Price per m/each
1154132	770291101	1/8 STAB	11	16	11	0,0078	100	10	pce	2,01
1154144	770291201	1/8 STAG	11	16	11	0,008	100	10	pce	2,57
1154133	770291102	1/4 STAB	14	18	14	0,0136	100	10	pce	2,06
1154145	770291202	1/4 STAG	14	18	14	0,014	100	10	pce	2,56
1154134	770291103	3/8 STAB	18	20	18	0,0232	100	10	pce	2,12
1154146	770291203	3/8 STAG	18	20	18	0,0239	100	10	pce	2,98
1154135	770291104	1/2 B	22	24	22	0,0329	200	10	pce	2,25
1154147	770291204	1/2 G	22	24	22	0,0335	200	10	pce	3,89
1154136	770291105	3/4 B	27	26	27	0,05	100	10	pce	2,92
1154148	770291205	3/4 G	27	26	27	0,0517	100	10	pce	4,92
1154137	770291106	1 B	34	33	34	0,098	60	10	pce	3,92
1154149	770291206	1 G	34	33	34	0,102	60	10	pce	6,03
1154138	770291107	1 1/4 B	43	36	43	0,132	4320	80	pce	5,32
1154150	770291207	1 1/4 G	43	36	43	0,136	4320	80	pce	9,74
1154139	770291108	1 1/2 B	49	37	49	0,165	3780	70	pce	9,97
1154151	770291208	1 1/2 G	49	37	49	0,169	3780	70	pce	15,11
1154140	770291109	2 B	60	44	60	0,2492	2700	50	pce	13,96
1154152	770291209	2 G	60	44	60	0,2573	2700	50	pce	21,18
1154141	770291110	2 1/2 B	76	52	76	0,462	1350	25	pce	22,79
1154153	770291210	2 1/2 G	76	52	76	0,475	1350	25	pce	41,00
1154142	770291111	3 B	88	59	88	0,62	1080	20	pce	42,08
1154154	770291211	3 G	88	59	88	0,628	1080	20	pce	66,35
1154143	770291112	4 B	113	66	113	1,378	540	10	pce	84,27
1154155	770291212	4 G	113	66	113	1,36	540	10	pce	122,24

GF Malleable Fittings plug plain 291a

- Plug, plain, solid
- Square nut

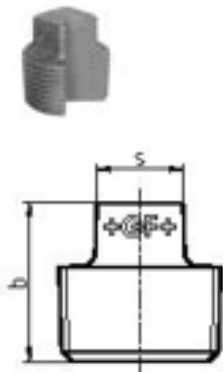

Item No.	Item no. GF	Dimensions	L mm	W mm	H mm	W kg	Pallet/ Pack	Box/M QTY	UOM	Price per m/each
1154156	770292105	3/4 B	27	28	27	0,088	100	10	pce	6,83
1154161	770292205	3/4 G	27	28	27	0,086	100	10	pce	11,76
1154157	770292106	1 B	34	33	34	0,147	50	10	pce	10,16
1154162	770292206	1 G	34	33	34	0,151	50	10	pce	15,51
1154158	770292107	1 1/4 B	43	36	43	0,251	2880	40	pce	15,31
1154163	770292207	1 1/4 G	43	36	43	0,257	2880	40	pce	24,49
1154159	770292108	1 1/2 B	49	38	49	0,327	2160	30	pce	19,79
1154164	770292208	1 1/2 G	49	38	49	0,337	2160	30	pce	33,01
1154160	770292109	2 B	60	44	60	0,608	720	10	pce	28,37
1154165	770292209	2 G	60	44	60	0,611	720	10	pce	43,36

Malleable Fittings

GF Malleable Fittings plug 294

- Plug
- Square nut with pre-drilled hole

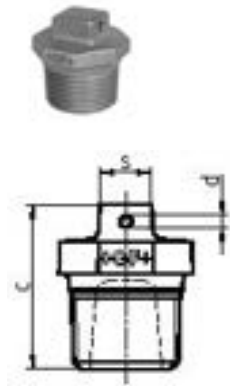

Item No.	Item no. GF	Dimensions	s mm	Pallet/ Pack	Box/M QTY	UOM	Price per m/each
1154166	770294104	1/2 B	11	250	10	pce	9,50
1154172	770294204	1/2 G	29 32 27 0,066	250	10	pce	14,35
1154167	770294105	3/4 B	34 37 32 0,103	100	10	pce	11,64
1154173	770294205	3/4 G	34 37 32 0,11	100	10	pce	17,57
1154168	770294106	1 B	43 41 40 0,152	40	10	pce	14,93
1154174	770294206	1 G	43 41 40 0,154	40	10	pce	22,55
1154169	770294107	1 1/4 B	22	2520	70	pce	20,19
1154175	770294207	1 1/4 G	49 47 45 0,2377	2520	70	pce	30,32
1154170	770294108	1 1/2 B	22	1800	50	pce	21,42
1154176	770294208	1 1/2 G	60 47 55 0,327	1800	50	pce	32,17
1154171	770294109	2 B	27	1080	30	pce	34,31
1154177	770294209	2 G	70 54 65 0,512	1080	30	pce	51,53

GF Malleable Fittings cap 300

- Cap, ISO/EN T1
- 'ST' these types of fittings are made from steel (galvanised finish = electroplated)
- Not suitable for drinking water installations.

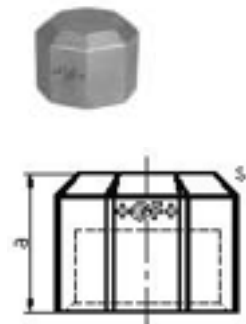

Item No.	Item no. GF	Dimensions	L mm	W mm	H mm	W kg	Pallet/ Pack	Box/M QTY	UOM	Price per m/each
1154179	770300101	1/8 STAB	17	14	14	0,015	100	10	pce	7,58
1154180	770300102	1/4 STAB	20	17	17	0,02	100	10	pce	2,96
1154192	770300202	1/4 STAG	20	17	17	0,02	100	10	pce	5,13
1154181	770300103	3/8 STAB	26	18	22	0,035	100	10	pce	4,21
1154193	770300203	3/8 STAG	26	18	22	0,036	100	10	pce	5,22
1154182	770300104	1/2 B	29	24	26	0,055	100	10	pce	3,27
1154194	770300204	1/2 G	29	24	26	0,057	100	10	pce	5,32
1154183	770300105	3/4 B	36	26	32	0,088	150	10	pce	3,75
1154195	770300205	3/4 G	36	26	32	0,091	150	10	pce	6,11
1154184	770300106	1 B	41	29	38	0,109	100	10	pce	4,70
1154196	770300206	1 G	41	29	38	0,115	100	10	pce	8,14
1154185	770300107	1 1/4 B	50	34	47	0,178	2880	80	pce	7,84
1154197	770300207	1 1/4 G	50	34	47	0,186	2880	80	pce	13,26
1154186	770300108	1 1/2 B	57	34	53	0,219	2700	50	pce	9,29
1154198	770300208	1 1/2 G	57	34	53	0,226	2700	50	pce	16,79
1154187	770300109	2 B	73	39	68	0,406	1620	30	pce	19,42
1154199	770300209	2 G	73	39	68	0,411	1620	30	pce	31,15
1154188	770300110	2 1/2 B	90	44	86	0,7025	1080	20	pce	35,33
1154200	770300210	2 1/2 G	90	44	86	0,728	1080	20	pce	68,92
1154189	770300111	3 B	101	50	96	0,798	432	12	pce	46,62
1154201	770300211	3 G	101	50	96	0,835	432	12	pce	78,03
1154190	770300112	4 B	135	54	128	1,78	432	8	pce	102,09
1154202	770300212	4 G	135	54	128	1,82	432	8	pce	170,86

Malleable Fittings

GF Malleable Fittings backnut 310

- Backnut, ISO/EN P4
- 'ST' these types of fittings are made from steel (galvanised finish = electroplated).

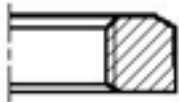
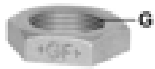

Item No.	Item no. GF	Dimensions	s mm	Pallet/ Pack	Box/M QTY	UOM	Price per m/each
1154227	770310101	1/8 STAB	22 7 19 0,012	200	10	pce	7,33
1154238	770310201	1/8 STAG 19		200	10	pce	11,11
1154228	770310102	1/4 STAB	26 8 22 0,016	100	10	pce	4,05
1154239	770310202	1/4 STAG	26 8 22 0,017	100	10	pce	6,09
1154229	770310103	3/8 STAB	32 8 27 0,026	100	10	pce	4,53
1154240	770310203	3/8 STAG	32 8 27 0,027	100	10	pce	6,78
1154230	770310104	1/2 B	37 9 32 0,035	150	10	pce	3,54
1154241	770310204	1/2 G	37 9 32 0,036	150	10	pce	5,36
1154231	770310105	3/4 B	42 10 36 0,043	100	10	pce	3,77
1154242	770310205	3/4 G	42 10 36 0,044	100	10	pce	5,73
1154232	770310106	1 B	54 12 46 0,088	150	10	pce	4,99
1154243	770310206	1 G	54 12 46 0,092	150	10	pce	7,51
1154244	770310207	1 1/4 G	64 13 56 0,126	3600	50	pce	12,50
1154234	770310108	1 1/2 B	69 14 60 0,1285	2880	40	pce	9,62
1154245	770310208	1 1/2 G	69 14 60 0,1325	2880	40	pce	14,38
1154235	770310109	2 B	86 16 73 0,222	2700	50	pce	19,16
1154246	770310209	2 G	86 16 73 0,23	2700	50	pce	28,78
1154236	770310110	2 1/2 B	107 19 95 0,417	1350	25	pce	42,04
1154247	770310210	2 1/2 G	107 19 95 0,43	1350	25	pce	65,23
1154237	770310111	3 B	118 22 105 0,505	720	20	pce	49,85
1154248	770310211	3 G	118 22 105 0,522	720	20	pce	77,35

GF Malleable Fittings backnut 310a

- Backnut, with one machined face, ISO/EN P4

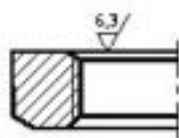
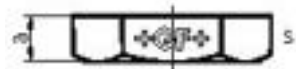

Item No.	Item no. GF	Dimensions	s mm	Pallet/ Pack	Box/M QTY	UOM	Price per m/each
1154215	770309104	1/2 B	32	10800	150	pce	10,90
1154221	770309204	1/2 G	37 9 32 0,0309	10800	150	pce	16,50
1154216	770309105	3/4 B	36	10800	150	pce	6,84
1154222	770309205	3/4 G	42 10 36 0,0357	10800	150	pce	10,37
1154217	770309106	1 B	46	8100	150	pce	12,76
1154223	770309206	1 G	53 12 46 0,079	8100	150	pce	19,37
1154218	770309107	1 1/4 B	56	3600	50	pce	14,86
1154224	770309207	1 1/4 G	64 13 56 0,115	3600	50	pce	22,32
1154219	770309108	1 1/2 B	69 14 60 0,1188	3600	50	pce	15,36
1154225	770309208	1 1/2 G	69 14 60 0,1264	3600	50	pce	23,11
1154220	770309109	2 B	86 16 73 0,203	2700	50	pce	34,31
1154226	770309209	2 G	73	2700	50	pce	51,53

Malleable Fittings

GF Malleable Fittings screwed flange 321

- Screwed flange, undrilled
- Plain flange for bespoke patterns or fabrication

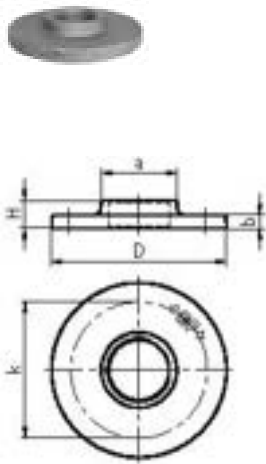

Item No.	Item no. GF	Dimensions	k mm	Pallet/ Pack	Box/M QTY	UOM	Price per m/each
1154265	770320104	1/2 B	55	2160	30	pce	19,98
1154271	770320204	1/2 G	55	2160	30	pce	31,57
1154266	770320105	3/4 B	65	1800	25	pce	24,67
1154272	770320205	3/4 G	65	1800	25	pce	35,74
1154267	770320106	1 B	75	1440	20	pce	27,52
1154273	770320206	1 G	75	1440	20	pce	41,73
1154268	770320107	1 1/4 B	90	720	10	pce	39,34
1154274	770320207	1 1/4 G	120 21 120 0,77	720	10	pce	59,11
1154269	770320108	1 1/2 B	100	720	20	pce	49,79
1154275	770320208	1 1/2 G	130 21 130 0,9782	720	20	pce	71,63
1154270	770320109	2 B	110	540	15	pce	57,70
1154276	770320209	2 G	110	540	15	pce	86,63

GF Malleable Fittings screwed flange 326

- Screwed flange, drilled, 2 holes

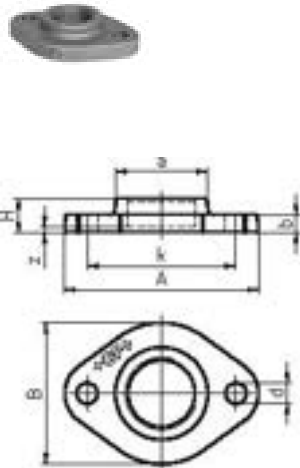

Item No.	Item no. GF	Dimensions	z mm	k mm	Pallet/ Pack	Box/M QTY	UOM	Price per m/each
1154277	770326104	1/2 B	80	17 45 0,183	2160	30	pce	32,45
1154283	770326204	1/2 G	80	17 45 0,191	2160	30	pce	49,08
1154278	770326105	3/4 B	90	19 64 0,314	2160	30	pce	41,93
1154284	770326205	3/4 G	90	19 64 0,322	2160	30	pce	63,47
1154279	770326106	1 B	100	20 72 0,404	1440	20	pce	43,13
1154285	770326206	1 G	100	20 72 0,416	1440	20	pce	65,24
1154280	770326107	1 1/4 B	3 90		864	12	pce	57,00
1154286	770326207	1 1/4 G	120	22 85 0,615	864	12	pce	85,62
1154281	770326108	1 1/2 B	130	23 95 0,71	720	10	pce	63,58
1154287	770326208	1 1/2 G	130	23 95 0,737	720	10	pce	95,48
1154282	770326109	2 B	140	24 100 0,835	720	10	pce	66,59
1154288	770326209	2 G	140	24 100 0,853	720	10	pce	99,99

Malleable Fittings

GF Malleable Fittings screwed flange 329

- Screwed flange, drilled, 4 holes
- Diameter of pitch circle and sealing face compatible to BS EN 1092-2 and DIN 2566.
- * 4 holes

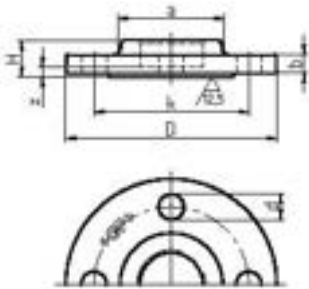

Item No.	Item no. GF	Dimensions	z mm	k mm	Pallet/ Pack	Box/M QTY	UOM	Price per m/each
1154289	770329104	1/2 B	95	20 95	720	10	pce	83,45
1154299	770329204	1/2 G	95	20 95	720	10	pce	126,20
1154290	770329105	3/4 B	9	75	720	10	pce	91,01
1154300	770329205	3/4 G	105	24 105	720	10	pce	137,67
1154291	770329106	1 B	7	85	360	5	pce	104,81
1154301	770329206	1 G	115	24 115	360	5	pce	158,45
1154292	770329107	1 1/4 B	140	26 140	540	10	pce	143,29
1154302	770329207	1 1/4 G	140	26 140	540	10	pce	215,20
1154293	770329108	1 1/2 B	150	26 150	360	10	pce	152,88
1154303	770329208	1 1/2 G	150	26 150	360	10	pce	229,58
1154294	770329109	2 B	165	29 165	288	8	pce	177,15
1154304	770329209	2 G	165	29 165	288	8	pce	265,98
1154295	770329110	2 1/2 B	185	32 185	216	6	pce	201,08
1154305	770329210	2 1/2 G	185	32 185	216	6	pce	311,73
1154296	770329111	3 4L B	200	36 200	216	4	pce	232,41
1154306	770329211	3 4L G	200	36 200	216	4	pce	360,28

GF Malleable Fittings screwed flange 329

- Screwed flange, drilled
- Diameter of pitch circle and sealing face compatible to BS EN 1092-2 and DIN 2566.
- * 8 holes

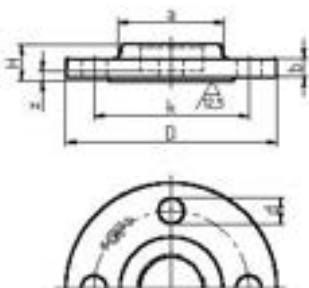

Item No.	Item no. GF	Dimensions	z mm	k mm	Pallet/ Pack	Box/M QTY	UOM	Price per m/each
1154298	770329115	3 8L B	6	160	216	4	pce	243,61
1154308	770329215	3 8L G	200	36 200	216	4	pce	377,72
1154297	770329112	4 B	220	38 220	108	3	pce	280,79
1154307	770329212	4 G	220	38 220	108	3	pce	435,32

Malleable Fittings

GF Malleable Fittings union flat seat 330

- Union flat seat, ISO/EN U1
- Supplied without sealing gaskets
- a and z1 include the seal thickness as per table "Sealing Gasket Dimension".
- '374 G' refers to the thread size 'G' according to ISO 228 of the union nut 374
- * Inside hexagon

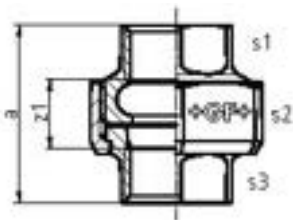

Item No.	Item no. GF	Dimensions	L mm	W mm	H mm	W kg	Pallet/ Pack	Box/M QTY	UOM	Price per m/each
1154309	770330102	1/4 B	31	42	28	0,0785	4320	60	pce	26,00
1154320	770330202	1/4 G	31	42	28	0,0808	4320	60	pce	39,31
1154310	770330103	3/8 B	35	47	32	0,109	40	10	pce	19,09
1154321	770330203	3/8 G	35	47	32	0,112	40	10	pce	28,87
1154311	770330104	1/2 B	45	48	41	0,181	70	10	pce	14,04
1154322	770330204	1/2 G	45	48	41	0,186	70	10	pce	21,70
1154312	770330105	3/4 B	53	52	48	0,263	50	10	pce	16,49
1154323	770330205	3/4 G	53	52	48	0,267	50	10	pce	25,38
1154313	770330106	1 B	59	59	55	0,363	1620	30	pce	19,08
1154324	770330206	1 G	59	59	55	0,372	1620	30	pce	29,23
1154314	770330107	1 1/4 B	74	65	67	0,6152	1080	20	pce	34,50
1154325	770330207	1 1/4 G	74	65	67	0,63	1080	20	pce	52,64
1154315	770330108	1 1/2 B	81	70	74	0,751	810	15	pce	43,75
1154326	770330208	1 1/2 G	81	70	74	0,762	810	15	pce	66,04
1154316	770330109	2 B	99	80	90	1,152	540	10	pce	65,22
1154327	770330209	2 G	99	80	90	1,162	540	10	pce	99,63
1154317	770330110	2 1/2 B	117	85	111	1,7079	270	5	pce	169,68
1154328	770330210	2 1/2 G	117	85	111	1,7292	270	5	pce	263,10
1154318	770330111	3 B	138	96	131	2,364	216	8	pce	253,91
1154329	770330211	3 G	138	96	131	2,377	216	8	pce	393,67
1154319	770330112	4 B	160	111	151	3,084	108	4	pce	584,31
1154330	770330212	4 G	160	111	151	3,07	108	4	pce	918,49

Malleable Fittings

GF Malleable Fittings union flat seat 331

- Union flat seat, ISO/EN U2
- Supplied without sealing gaskets
- b and z2 include the seal thickness as per table "Sealing Gasket Dimension".
- '374 G' refers to the thread size 'G' according to ISO 228 of the union nut 374

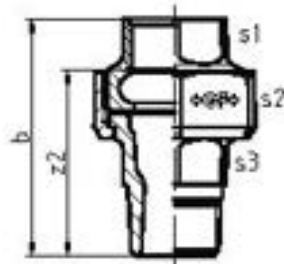

Item No.	Item no. GF	Dimensions	L mm	W mm	H mm	W kg	Pallet/ Pack	Box/M QTY	UOM	Price per m/each
1154331	770331102	1/4 B	31	55	28	0,0915	5400	150	pce	27,28
1154341	770331202	1/4 G	31	55	28	0,0945	5400	150	pce	41,20
1154332	770331103	3/8 B	35	58	32	0,12	40	10	pce	22,75
1154342	770331203	3/8 G	35	58	32	0,123	40	10	pce	34,42
1154333	770331104	1/2 B	45	66	41	0,221	70	10	pce	17,31
1154343	770331204	1/2 G	45	66	41	0,223	70	10	pce	26,16
1154334	770331105	3/4 B	53	72	48	0,305	40	10	pce	19,47
1154344	770331205	3/4 G	53	72	48	0,31	40	10	pce	29,47
1154335	770331106	1 B	59	80	55	0,4166	1620	30	pce	23,69
1154345	770331206	1 G	59	80	55	0,4326	1620	30	pce	35,88
1154336	770331107	1 1/4 B	74	90	67	0,7358	810	15	pce	46,37
1154346	770331207	1 1/4 G	74	90	67	0,7522	810	15	pce	69,68
1154337	770331108	1 1/2 B	81	95	74	0,9035	540	10	pce	56,01
1154347	770331208	1 1/2 G	81	95	74	0,899	540	10	pce	84,08
1154338	770331109	2 B	99	107	90	1,417	432	8	pce	87,79
1154348	770331209	2 G	99	107	90	1,412	432	8	pce	131,86
1154339	770331110	2 1/2 B	117	118	111	2,135	216	4	pce	195,68
1154349	770331210	2 1/2 G	117	118	111	2,2552	216	4	pce	303,36
1154340	770331111	3 B	138	131	131	2,871	162	6	pce	286,55
1154350	770331211	3 G	138	131	131	2,947	162	6	pce	443,72

GF Malleable Fittings union flat seat 332

- Union flat seat
- Supplied without sealing gaskets
- b and z include the seal thickness as per table "Sealing Gasket Dimension".
- '374 G' refers to the thread size 'G' according to ISO 228 of the union nut 374

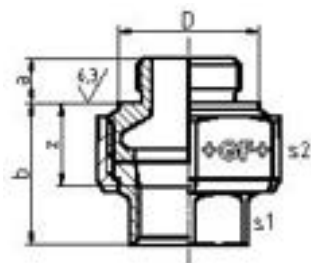

Item No.	Item no. GF	Dimensions	s1 mm	s2 mm	z mm	Pallet/ Pack	Box/M QTY	UOM	Price per m/each
1154351	770332105	3/4 B	31	48	24	2700	50	pce	31,29
1154354	770332205	3/4 G			53 51 48	2700	50	pce	47,33
1154352	770332106	1 B	38	55	25	2160	40	pce	34,13
1154355	770332206	1 G			59 56 55	2160	40	pce	51,61
1154353	770332107	1 1/4 B	48	67	31	1080	20	pce	51,48
1154356	770332207	1 1/4 G			74 66 67	1080	20	pce	77,31

Malleable Fittings

GF Malleable Fittings union flat seat 335

- Union flat seat
- Supplied without sealing gaskets
- c + z2 include the seal thickness as per table "Sealing Gasket Dimension".
- '374 G' refers to the thread size 'G' according to ISO 228 of the union nut 374

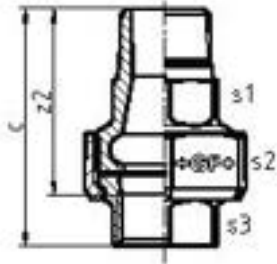

Item No.	Item no. GF	Dimensions	s1 mm	s2 mm	s3 mm	z2 mm	Pallet/ Pack	Box/M QTY	UOM	Price per m/each
1154357	770335104	1/2 B	26	41	26	53	2880	80	pce	27,01
1154362	770335204	1/2 G				45 66 41 0,2217	2880	80	pce	40,85
1154358	770335105	3/4 B	32	48	31	57	1800	50	pce	27,01
1154363	770335205	3/4 G				53 72 48 0,3335	1800	50	pce	40,85
1154359	770335106	1 B				59 82 55 0,4588	1350	25	pce	30,10
1154364	770335206	1 G				59 82 55 0,4728	1350	25	pce	45,56
1154360	770335107	1 1/4 B	48	67	48	71	1080	20	pce	49,01
1154365	770335207	1 1/4 G				74 90 67 0,74	1080	20	pce	73,56
1154361	770335108	1 1/2 B				81 95 74 0,891	540	10	pce	61,58
1154366	770335208	1 1/2 G				81 95 74 0,896	540	10	pce	92,44

GF Malleable Fittings union flat seat 336

- Union flat seat
- Supplied without sealing gaskets
- c includes the seal thickness as per table "Sealing Gasket Dimension".
- '374 G' refers to the thread size 'G' according to ISO 228 of the union nut 374

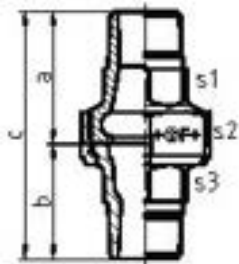

Item No.	Item no. GF	Dimensions	L mm	W mm	H mm	W kg	Pallet/ Pack	Box/M QTY	UOM	Price per m/each
1154367	770336104	1/2 B	45	85	41	0,2533	3240	60	pce	29,04
1154372	770336204	1/2 G	45	85	41	0,2587	3240	60	pce	43,56
1154368	770336105	3/4 B	53	92	48	0,365	2160	40	pce	30,10
1154373	770336205	3/4 G	53	92	48	0,3772	2160	40	pce	45,56
1154369	770336106	1 B	59	103	55	0,5186	1080	20	pce	34,90
1154374	770336206	1 G	59	103	55	0,5366	1080	20	pce	52,70
1154370	770336107	1 1/4 B	74	114	67	0,8318	810	15	pce	58,08
1154375	770336207	1 1/4 G	74	114	67	0,8622	810	15	pce	87,12
1154371	770336108	1 1/2 B	81	120	74	0,984	540	10	pce	69,59
1154376	770336208	1 1/2 G	81	120	74	1,052	540	10	pce	105,87

Malleable Fittings

GF Malleable Fittings union taper seat 340

- Union taper seat, ISO/EN U11
- Torque and notes for installation please find in "Technical Product Notes".
- '374 G' refers to the thread size 'G' according to ISO 228 of the union nut 374
- * Inside hexagon
- ** Version

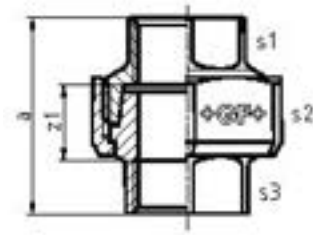

Item No.	Item no. GF	Dimensions	s1 mm	s2 mm	s3 mm	z1 mm	Pallet/ Pack	Box/M QTY	UOM	Price per m/each
1154380	770340101	1/8 B	29	38	26	0,0684	5760	80	pce	54,06
1154393	770340201	1/8 G	29	38	26	0,0702	5760	80	pce	81,74
1154381	770340102	1/4 B	31	42	28	0,0807	4320	60	pce	18,77
1154394	770340202	1/4 G	31	42	28	0,0833	4320	60	pce	33,76
1154382	770340103	3/8 B	35	48	32	0,1155	2880	40	pce	15,59
1154395	770340203	3/8 G	35	48	32	0,1189	2880	40	pce	30,09
1154383	770340104	1/2 B	45	48	41	0,2	70	10	pce	13,38
1154396	770340204	1/2 G	45	48	41	0,204	70	10	pce	22,65
1154384	770340105	3/4 B	53	52	48	0,262	50	10	pce	14,64
1154397	770340205	3/4 G	53	52	48	0,266	50	10	pce	24,83
1154385	770340106	1 B	59	58	55	0,3773	1620	30	pce	17,12
1154398	770340206	1 G	59	58	55	0,3856	1620	30	pce	29,09
1154386	770340107	1 1/4 B	74	65	67	0,6132	1080	20	pce	30,91
1154399	770340207	1 1/4 G	74	65	67	0,629	1080	20	pce	46,87
1154387	770340108	1 1/2 B	81	70	74	0,776	810	15	pce	34,89
1154400	770340208	1 1/2 G	81	70	74	0,8	810	15	pce	52,91
1154388	770340109	2 B	99	78	90	1,203	540	10	pce	57,80
1154401	770340209	2 G	99	78	90	1,197	540	10	pce	78,88
1154389	770340110	2 1/2 B	117	90	111	1,963	270	5	pce	124,67
1154402	770340210	2 1/2 G	117	90	111	2,009	270	5	pce	222,64
1154390	770340111	3 B	138	101	131	2,454	216	4	pce	195,68
1154403	770340211	3 G	138	101	131	2,476	216	4	pce	346,02
1154391	770340112	4 B	160	114	151	3,155	108	4	pce	372,54
1154404	770340212	4 G	160	114	151	3,208	108	4	pce	658,72

Malleable Fittings

GF Malleable Fittings union taper seat 341

- Union taper seat, ISO/EN U12
- Torque and notes for installation please find in "Technical Product Notes".
- '374 G' refers to the thread size 'G' according to ISO 228 of the union nut 374

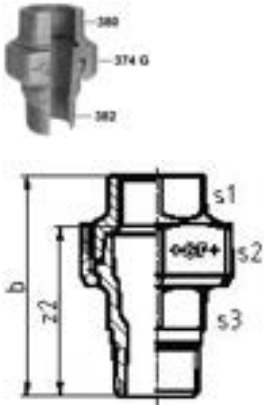

Item No.	Item no. GF	Dimensions	L mm	W mm	H mm	W kg	Pallet/ Pack	Box/M QTY	UOM	Price per m/each
1154414	770341102	1/4 B	31	55	28	0,094	3600	50	pce	22,45
1154425	770341202	1/4 G	31	55	28	0,101	3600	50	pce	36,29
1154415	770341103	3/8 B	35	59	32	0,1345	3600	100	pce	17,87
1154416	770341104	1/2 B	45	66	41	0,231	70	10	pce	15,29
1154427	770341204	1/2 G	45	66	41	0,233	70	10	pce	25,39
1154417	770341105	3/4 B	53	72	48	0,313	40	10	pce	18,74
1154428	770341205	3/4 G	53	72	48	0,32	40	10	pce	30,96
1154418	770341106	1 B	59	80	55	0,4436	1620	30	pce	23,38
1154429	770341206	1 G	59	80	55	0,4606	1620	30	pce	36,17
1154419	770341107	1 1/4 B	74	90	67	0,7367	810	15	pce	37,28
1154430	770341207	1 1/4 G	74	90	67	0,76	810	15	pce	74,14
1154420	770341108	1 1/2 B	81	96	74	0,922	540	10	pce	47,66
1154431	770341208	1 1/2 G	81	96	74	0,945	540	10	pce	94,21
1154421	770341109	2 B	99	106	90	1,419	324	6	pce	75,11
1154432	770341209	2 G	99	106	90	1,446	324	6	pce	148,31
1154422	770341110	2 1/2 B	117	122	111	2,455	216	4	pce	199,73
1154433	770341210	2 1/2 G	117	122	111	2,47	216	4	pce	334,16
1154423	770341111	3 B	138	134	131	2,967	162	6	pce	274,58
1154434	770341211	3 G	138	134	131	3,001	162	6	pce	459,45
1154424	770341112	4 B	160	153	151	4,085	54	2	pce	574,41
1154435	770341212	4 G	160	153	151	4,153	54	2	pce	948,68

GF Malleable Fittings union CuSn/Fe seat 342

- Union, spherical seat/taper seat Bronze to Iron, ISO/EN U11
- Torque and notes for installation please find in "Technical Product Notes".
- Not suitable for drinking water installation!
- '374 G' refers to the thread size 'G' according to ISO 228 of the union nut 374

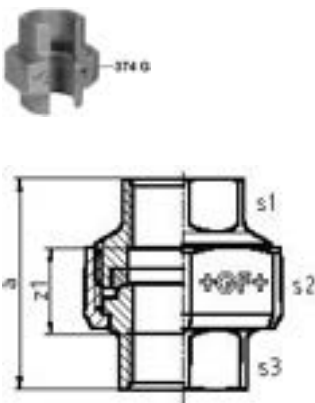

Item No.	Item no. GF	Dimensions	L mm	W mm	H mm	W kg	Pallet/ Pack	Box/M QTY	UOM	Price per m/each
1154442	770342104	1/2 B	48	48	44	0,216	3780	70	pce	27,76
1154448	770342204	1/2 G	48	48	44	0,2253	3780	70	pce	55,21
1154443	770342105	3/4 B	53	52	48	0,2622	2700	50	pce	31,02
1154449	770342205	3/4 G	53	52	48	0,285	2700	50	pce	64,96
1154444	770342106	1 B	59	58	55	0,3726	1620	30	pce	40,92
1154450	770342206	1 G	59	58	55	0,3846	1620	30	pce	67,15
1154445	770342107	1 1/4 B	74	65	67	0,6272	1080	20	pce	59,70
1154451	770342207	1 1/4 G	74	65	67	0,6495	1080	20	pce	121,16
1154446	770342108	1 1/2 B	81	70	74	0,805	810	15	pce	77,91
1154452	770342208	1 1/2 G	81	70	74	0,828	810	15	pce	147,12
1154447	770342109	2 B	99	78	90	1,195	540	10	pce	91,72
1154453	770342209	2 G	99	78	90	1,224	540	10	pce	178,10

Malleable Fittings

GF Malleable Fittings union 2x CuSn seat 342a

- Union, spherical seat/taper seat Bronze to Bronze, ISO/ENU11
- Torque and notes for installation please find in "Technical Product Notes".
- Not suitable for drinking water installation!
- '374 G' refers to the thread size 'G' according to ISO 228 of the union nut 374

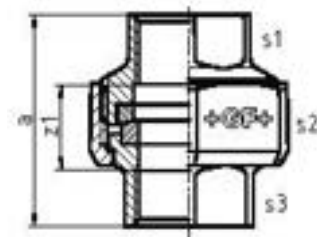

Item No.	Item no. GF	Dimensions	L mm	W mm	H mm	W kg	Pallet/ Pack	Box/M QTY	UOM	Price per m/each
1154470	770345104	1/2 B	48	48	44	0,22	3780	70	pce	38,07
1154476	770345204	1/2 G	48	48	44	0,2292	3780	70	pce	55,34
1154471	770345105	3/4 B	53	52	48	0,2565	2700	50	pce	39,30
1154477	770345205	3/4 G	53	52	48	0,259	2700	50	pce	65,73
1154472	770345106	1 B	59	58	55	0,3491	1620	30	pce	55,55
1154478	770345206	1 G	59	58	55	0,3596	1620	30	pce	80,19
1154473	770345107	1 1/4 B	74	65	67	0,637	1080	20	pce	76,27
1154479	770345207	1 1/4 G	74	65	67	0,5925	1080	20	pce	137,94
1154474	770345108	1 1/2 B	81	75	74	0,761	810	15	pce	92,18
1154480	770345208	1 1/2 G	81	75	74	0,743	810	15	pce	152,88
1154475	770345109	2 B	99	85	90	1,123	540	10	pce	117,09
1154481	770345209	2 G	99	85	90	1,089	540	10	pce	180,70

GF Malleable Fittings union taper seat 344

- Union taper seat
- Torque and notes for installation please find in "Technical Product Notes".
- '374 G' refers to the thread size 'G' according to ISO 228 of the union nut 374.

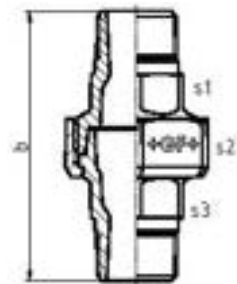

Item No.	Item no. GF	Dimensions	L mm	W mm	H mm	W kg	Pallet/ Pack	Box/M QTY	UOM	Price per m/each
1154454	770344102	1/4 B	31	69	28	0,1	5040	70	pce	43,74
1154462	770344202	1/4 G	31	69	28	0,106	5040	70	pce	66,16
1154455	770344103	3/8 B	35	75	32	0,1478	5400	100	pce	34,68
1154463	770344203	3/8 G	35	75	32	0,1535	5400	100	pce	52,44
1154456	770344104	1/2 B	45	85	41	0,2628	50	10	pce	36,69
1154464	770344204	1/2 G	45	85	41	0,2669	50	10	pce	55,46
1154457	770344105	3/4 B	53	93	48	0,363	1440	40	pce	42,21
1154465	770344205	3/4 G	53	93	48	0,373	1440	40	pce	63,91
1154458	770344106	1 B	59	103	55	0,538	900	25	pce	49,78
1154466	770344206	1 G	59	103	55	0,5486	900	25	pce	75,27
1154460	770344108	1 1/2 B	81	123	74	1,047	360	10	pce	103,21
1154468	770344208	1 1/2 G	81	123	74	1,0555	360	10	pce	155,02
1154459	770344107	1 1/4 B	74	114	67	0,8587	540	15	pce	90,39
1154467	770344207	1 1/4 G	74	114	67	0,8895	540	15	pce	135,74
1154461	770344109	2 B	99	136	90	1,616	216	6	pce	188,80
1154469	770344209	2 G	99	136	90	1,665	216	6	pce	287,07

Malleable Fittings

GF Malleable Fittings union angular deviator 346 max. 6deg

- Union, spherical seat angular deviation max. 6°, ISO/EN U11
- Torque and notes for installation please find in "Technical Product Notes".
- '374 G' refers to the thread size 'G' according to ISO 228 of the union nut 374.

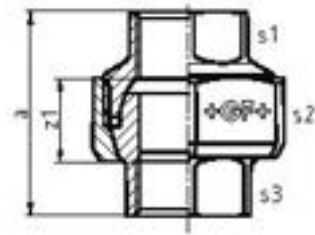

Item No.	Item no. GF	Dimensions	s1 mm	s2 mm	s3 mm	z1 mm	Pallet/ Pack	Box/M QTY	UOM	Price per m/each
1154482	770346104	1/2 B	26	44	26	22	3780	70	pce	31,24
1154488	770346204	1/2 G	26	44	26	22	3780	70	pce	47,29
1154483	770346105	3/4 B				53 52 48 0,259	2700	50	pce	38,24
1154489	770346205	3/4 G	31	48	31	23	2700	50	pce	53,95
1154484	770346106	1 B				59 58 55 0,362	1620	30	pce	47,20
1154490	770346206	1 G				59 58 55 0,373	1620	30	pce	66,53
1154491	770346207	1 1/4 G				74 65 67 0,6245	1080	20	pce	98,85
1154486	770346108	1 1/2 B				81 75 74 0,771	810	15	pce	86,36
1154492	770346208	1 1/2 G	54	73	54	32	810	15	pce	129,77
1154487	770346109	2 B				99 85 90 1,168	540	10	pce	121,84
1154493	770346209	2 G				99 85 90 1,0885	540	10	pce	185,36

GF Malleable Fittings union bush flat seat 370

- Union bush flat seat
- * Is usually not supplied as a separate piece.
- ** Version

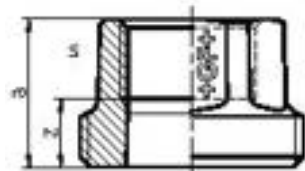

Item No.	Item no. GF	Dimensions	s mm	z mm	Pallet/ Pack	Box/M QTY	UOM	Price per m/each
1154517	770370119	1/2 B	34	25 34 0,0596	7200	100	pce	6,15
1154529	770370219	1/2 G	34	25 34 0,06	7200	100	pce	9,36
1154509	770370105	3/4 B	42	28 42 0,0962	5400	100	pce	6,36
1154519	770370205	3/4 G	42	28 42 0,0985	5400	100	pce	9,69
1154510	770370106	1 B	48	31 48 0,124	5400	100	pce	8,76
1154520	770370206	1 G	48	31 48 0,127	5400	100	pce	13,22
1154511	770370107	1 1/4 B	60	33 60 0,227	2700	50	pce	13,07
1154521	770370207	1 1/4 G	60	33 60 0,231	2700	50	pce	19,66
1154512	770370108	1 1/2 B	66	36 66 0,263	2160	40	pce	17,17
1154522	770370208	1 1/2 G	66	36 66 0,259	2160	40	pce	25,78
1154513	770370109	2 B	60	42 60 0,45	1080	20	pce	31,28
1154523	770370209	2 G	60	42 60 0,4636	1080	20	pce	46,97
1154524	770370210	2 1/2 G	85	14	810	30	pce	94,00

Malleable Fittings

GF Malleable Fittings union end flat seat 371

- Union end flat seat, reducing
- Union end for 374 1 d=42.5
- 'G' refers to the thread size 'G' of the union nut 374, which can be combined with the union end.

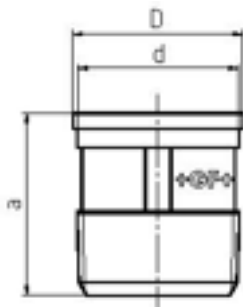

Item No.	Item no. GF	Dimensions	L mm	W mm	H mm	W kg	Pallet/ Pack	Box/M QTY	UOM	Price per m/each
1154541	770371115	1 - 1 1/4 B	44	47	44	0,157	3240	60	pce	23,49

GF Malleable Fittings union end flat seat 371

- Union end flat seat, equal
- 'G' refers to the thread size G of the union nut 374, which can be combined with the union end.
- * Is usually not supplied as a separate piece.

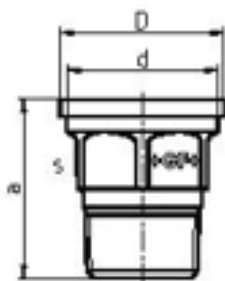

Item No.	Item no. GF	Dimensions	s mm	L mm	W mm	H mm	W kg	Pallet/ Pack	Box/M QTY	UOM	Price per m/each
1154533	770371104	1/2 B		30	40	30	0,0735	10800	200	pce	10,20
1154544	770371204	1/2 G		30	40	30	0,0747	10800	200	pce	15,44
1154534	770371105	3/4 B		39	42	39	0,1125	6480	120	pce	9,50
1154545	770371205	3/4 G	30					6480	120	pce	14,35
1154535	770371106	1 B		44	47	44	0,155	3780	70	pce	11,64
1154546	770371206	1 G		44	47	44	0,162	3780	70	pce	17,57
1154536	770371107	1 1/4 B		56	57	56	0,286	2700	50	pce	21,42
1154547	770371207	1 1/4 G		56	57	56	0,295	2700	50	pce	32,17
1154537	770371108	1 1/2 B		62	57	62	0,346	1620	30	pce	23,94
1154548	770371208	1 1/2 G		62	57	62	0,35	1620	30	pce	35,97
1154538	770371109	2 B		78	62	78	0,573	810	15	pce	35,07
1154549	770371209	2 G		78	62	78	0,584	810	15	pce	52,67

Malleable Fittings

GF Malleable Fittings union end flat seat 372

- Union end flat seat, equal
- 'G' refers to the thread size 'G' of the union nut 374, which can be combined with the union end.
- * Is usually not supplied as a separate piece.
- ** Version
- I hex = Internal hexagon

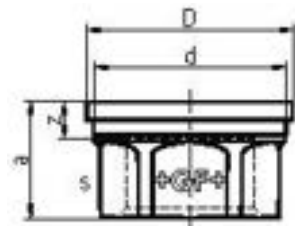

Item No.	Item no. GF	Dimensions	s mm	z mm	d mm	s mm	Pallet/ Pack	Box/M QTY	UOM	Price per m/each
1154563	770372119	1/2 B	30	22	30	0,0383	7200	100	pce	6,14
1154552	770372104	1/2 S B	35	22	35	0,051	7200	100	pce	6,14
1154578	770372219	1/2 G	30	22	30	0,0395	7200	100	pce	9,35
1154567	770372204	1/2 S G	35	22	35	0,053	7200	100	pce	9,35
1154553	770372105	3/4 B	39	22	39	0,073	8100	150	pce	6,63
1154568	770372205	3/4 G	39	22	39	0,075	8100	150	pce	10,02
1154554	770372106	1 B	44	26	44	0,097	6480	120	pce	6,13
1154569	770372206	1 G	44	26	44	0,0957	6480	120	pce	10,38
1154555	770372107	1 1/4 B	56	31	56	0,1734	3780	70	pce	11,10
1154570	770372207	1 1/4 G	56	31	56	0,1748	3780	70	pce	16,68
1154556	770372108	1 1/2 B	62	33	62	0,208	2700	50	pce	15,64
1154571	770372208	1 1/2 G	62	33	62	0,2148	2700	50	pce	21,02
1154557	770372109	2 B	78	35	78	0,335	1620	30	pce	25,24
1154572	770372209	2 G	78	35	78	0,3318	1620	30	pce	37,90
1154558	770372110	2 1/2 B	85	12,0			945	35	pce	53,52
1154573	770372210	2 1/2 G	97	39	97	0,544	945	35	pce	83,03

GF Malleable Fittings union end reducer flat seat 372

- Union end flat seat, reducing
- 'G' refers to the thread size G of the union nut 374, which can be combined with the union end.

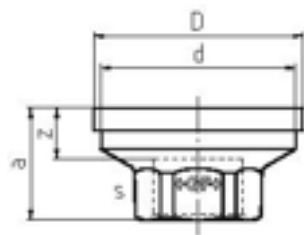

Item No.	Item no. GF	Dimensions	s mm	z mm	Pallet/ Pack	Box/M QTY	UOM	Price per m/each		
1154561	770372115	1 - 3/4 B	44	25	44	0,092	6480	120	pce	10,67
1154576	770372215	1 - 3/4 G	44	25	44	0,093	6480	120	pce	16,13
1154562	770372116	1 B	56	31	56	0,159	5400	100	pce	15,36
1154577	770372216	1 G	56	31	56	0,1599	5400	100	pce	24,76

Malleable Fittings

GF Malleable Fittings union bush flat seat 373

- Union bush flat seat
- Sealing gaskets for sealing surface as per table "Sealing Gasket Dimension" (catalogue no. 332, symbol).

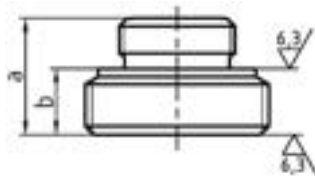

Item No.	Item no. GF	Dimensions	L mm	W mm	H mm	W kg	Pallet/ Pack	Box/M QTY	UOM	Price per m/each
1154582	770373105	3/4 B	42	27	42	0,074	8100	150	pce	17,31
1154585	770373205	3/4 G	42	27	42	0,0775	8100	150	pce	26,16
1154583	770373106	1 B	48	29	48	0,101	5400	100	pce	19,46
1154586	770373206	1 G	48	29	48	0,1111	5400	100	pce	29,35
1154584	770373107	1 1/4 B	60	33	60	0,175	3780	70	pce	28,01
1154587	770373207	1 1/4 G	60	33	60	0,179	3780	70	pce	42,03

GF Malleable Fittings union nut 374

- Union nut
- * Is usually not supplied as a separate piece.
- ** Version
- *** Union nut for 371 1 - 1 1/4

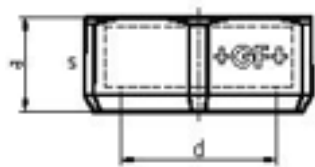

Item No.	Item no. GF	Dimensions	s mm	d mm	s mm	Pallet/ Pack	Box/M QTY	UOM	Price per m/each	
1154598	770374116	3/8 G3/4 B	35	16	32	0,0415	10800	150	pce	4,53
1154613	770374216	3/8 G3/4 G	35	16	32	0,0425	10800	150	pce	6,78
1154599	770374119	1/2 G1 B	45	18	41	0,0865	8100	150	pce	4,73
1154600	770374120	1/2 G1 1/8 S B	48	19	44	0,087	8100	150	pce	5,20
1154614	770374219	1/2 G1 G	45	18	41	0,0882	8100	150	pce	7,18
1154615	770374220	1/2 G1 1/8 S G	48	19	44	0,0892	8100	150	pce	7,88
1154589	770374105	3/4 B	53	20	48	0,0941	5400	100	pce	5,22
1154603	770374135	3/4 3/4 B	53	20	48	0,094	5400	100	pce	6,14
1154605	770374205	3/4 G	53	20	48	0,095	5400	100	pce	8,95
1154590	770374106	1 S B	62	22	55	0,1405	4860	90	pce	5,88
1154601	770374121	1 425 B	62	22	55	0,138	4050	150	pce	5,91
1154606	770374206	1 S G	62	22	55	0,1446	4860	90	pce	10,03
1154592	770374108	1 1/2 B	81	25	74	0,28	2160	40	pce	13,87
1154608	770374208	1 1/2 G	81	25	74	0,283	2160	40	pce	21,07
1154591	770374107	1 1/4 B	74	24	67	0,224	2700	50	pce	9,87
1154607	770374207	1 1/4 G	74	24	67	0,223	2700	50	pce	16,68
1154593	770374109	2 B	99	27	90	0,3776	1350	50	pce	20,65
1154609	770374209	2 G	99	27	90	0,387	1350	50	pce	31,08
1154594	770374110	2 1/2 B	117	30	111	0,515	810	15	pce	48,92
1154610	770374210	2 1/2 G	117	30	111	0,52	810	15	pce	97,43
1154595	770374111	3 B	138	31	131	0,905	648	12	pce	64,58
1154611	770374211	3 G	138	31	131	0,91	648	12	pce	100,11

Malleable Fittings

GF Malleable Fittings union bush flat seat 376

- Union bush flat seat
- ** Version

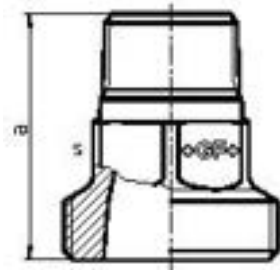

Item No.	Item no. GF	Dimensions	s mm	Pallet/ Pack	Box/M QTY	UOM	Price per m/each
1154622	770376105	1/2 B	26	8100	150	pce	17,11
1154629	770376205	1/2 G	26	8100	150	pce	20,09
1154623	770376106	3/4 B	32	3600	100	pce	20,15
1154630	770376206	3/4 G	32	3600	100	pce	23,64
1154624	770376107	1 B	38	2160	60	pce	20,43
1154631	770376207	1 G	38	2160	60	pce	23,99
1154625	770376108	1 1/4 B	48	1440	40	pce	32,10
1154632	770376208	1 1/4 G	48	1440	40	pce	37,13
1154626	770376109	1 1/2 B	54	1080	30	pce	39,95
1154633	770376209	1 1/2 G	54	1080	30	pce	46,20

GF Malleable Fittings distribution union bush flat seat 378

- Distributed union bush, flat seat

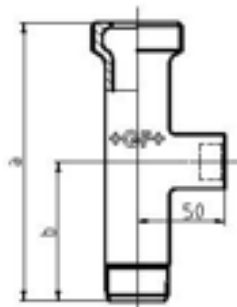

Item No.	Item no. GF	Dimensions	L mm	W mm	H mm	W kg	Pallet/ Pack	Box/M QTY	UOM	Price per m/each
1154637	770378221	1 G	75	146	49	0,548	540	10	pce	102,72
1154638	770378222	1 1/4 G	80	141	60	0,6875	540	10	pce	141,09

GF Malleable Fittings bracket elbow 471

- Bracket elbow

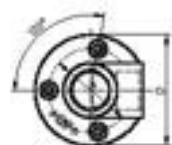
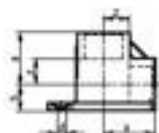

Item No.	Item no. GF	Dimensions	z mm	k mm	Pallet/ Pack	Box/M QTY	UOM	Price per m/each
1154716	770471203	3/8 G	15	41,5	30	10	pce	55,86
1154717	770471204	1/2 G	15	44,5	60	10	pce	35,55
1154718	770471205	3/4 G	18	53,5	30	10	pce	68,89

Malleable Fittings

GF Malleable Fittings extension tube 526

- Extension tube
- * Due to overall fitting length, the length of the external thread does not comply with the standard.

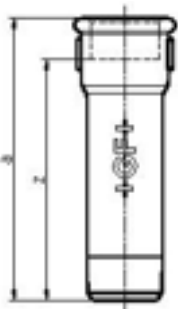

Item No.	Item no. GF	Dimensions	l mm	z mm	Pallet/ Pack	Box/M QTY	UOM	Price per m/each
1154719	770526119	3/8 100 B	100	90	50	10	pce	20,18
1154736	770526219	3/8 100 G	100	90	50	10	pce	30,50
1154720	770526120	1/2 30 B	30	17	100	10	pce	8,95
1154737	770526220	1/2 30 G	30	17	100	10	pce	13,67
1154721	770526121	1/2 50 B	50	37	60	10	pce	8,51
1154738	770526221	1/2 50 G	50	37	60	10	pce	12,91
1154722	770526122	1/2 60 B	60	47	50	10	pce	11,64
1154739	770526222	1/2 60 G	60	47	50	10	pce	17,57
1154723	770526123	1/2 70 B	70	57	40	10	pce	15,42
1154740	770526223	1/2 70 G	70	57	40	10	pce	23,31
1154724	770526124	1/2 80 B	80	67	40	10	pce	11,86
1154741	770526224	1/2 80 G	80	67	40	10	pce	17,90
1154725	770526125	1/2 100 B	100	87	80	10	pce	16,10
1154742	770526225	1/2 100 G	100	87	80	10	pce	24,35
1154726	770526126	1/2 120 B	120	107	30	10	pce	24,92
1154743	770526226	1/2 120 G	120	107	30	10	pce	38,17
1154727	770526127	3/4 30 B	30	15	60	10	pce	9,96
1154744	770526227	3/4 30 G	30	15	60	10	pce	15,03
1154728	770526128	3/4 40 B	40	25	50	10	pce	11,14
1154745	770526228	3/4 40 G	40	25	50	10	pce	16,85
1154729	770526129	3/4 60 B	60	45	80	10	pce	15,89
1154746	770526229	3/4 60 G	60	45	80	10	pce	23,99
1154730	770526130	3/4 70 B	70	55	60	10	pce	20,40
1154747	770526230	3/4 70 G	70	55	60	10	pce	30,81
1154731	770526131	3/4 80 B	80	65	60	10	pce	19,68
1154748	770526231	3/4 80 G	80	65	60	10	pce	29,77
1154732	770526132	3/4 100 B	100	85	50	10	pce	21,18
1154749	770526232	3/4 100 G	100	85	50	10	pce	30,14
1154733	770526133	1 40 B	40	23	40	10	pce	15,63
1154750	770526233	1 40 G	40	23	40	10	pce	23,64
1154734	770526134	1 80 B	80	63	40	10	pce	24,92
1154751	770526234	1 80 G	80	63	40	10	pce	37,65
1154735	770526135	1 100 B	100	83	1620	30	pce	37,48
1154752	770526235	1 100 G	100	83	1620	30	pce	56,66

Malleable Fittings

GF Malleable Fittings socket 529a

- Socket, internal and external thread, ISO/EN M4
- 'ST' these types of fittings are made from steel (galvanised finish = electroplated)
- Not suitable for drinking water installations
- Steel parts are hexagonal instead of beaded.

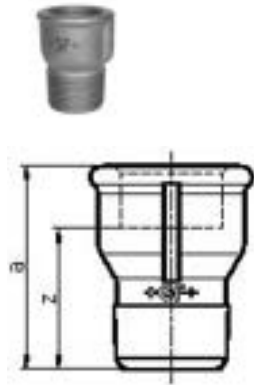

Item No.	Item no. GF	Dimensions	s mm	z mm	Pallet/ Pack	Box/M QTY	UOM	Price per m/each
1154753	770529102	1/4 STAB	17	18	100	10	pce	15,42
1154761	770529202	1/4 STAG	17	18	100	10	pce	23,31
1154754	770529103	3/8 STAB	22	25	100	10	pce	7,12
1154762	770529203	3/8 STAG	22	25	100	10	pce	10,77
1154755	770529104	1/2 B		30	60	10	pce	7,79
1154763	770529204	1/2 G		30	60	10	pce	11,83
1154756	770529105	3/4 B		33	100	10	pce	11,37
1154764	770529205	3/4 G		33	100	10	pce	17,23
1154757	770529106	1 B		38	60	10	pce	18,02
1154765	770529206	1 G		38	60	10	pce	27,58
1154758	770529107	1 1/4 B		41	2160	40	pce	24,95
1154766	770529207	1 1/4 G		41	2160	40	pce	37,49
1154759	770529108	1 1/2 B		44	1890	35	pce	34,81
1154767	770529208	1 1/2 G		44	1890	35	pce	52,26
1154760	770529109	2 B		46	1080	20	pce	57,00
1154768	770529209	2 G		46	1080	20	pce	85,62

GF Malleable Fittings longscrew hexagonal nipple 534

- Longscrew hexagon nipple
- Hot dip galvanised, thread electroplated.

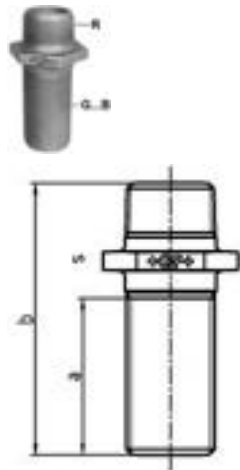

Item No.	Item no. GF	Dimensions	s mm	Pallet/ Pack	Box/M QTY	UOM	Price per m/each
1154769	770534204	1/2 G	32	2880	40	pce	51,61
1154770	770534205	3/4 G	36	2700	50	pce	68,21
1154771	770534206	1 G	46	1890	35	pce	97,99

Malleable Fittings

GF Malleable Fittings longcrew 535

- Longscrew hexagon nipple, complete
- * Large chamfer (gasket chamber)



Item No.	Item no. GF	Dimensions	s mm	Pallet/ Pack	Box/M QTY	UOM	Price per m/each
1154772	770535204	1/2 G	32	2700	50	pce	54,84
1154773	770535205	3/4 G	36	1800	50	pce	65,70
1154774	770535206	1 G	46	1620	30	pce	97,64

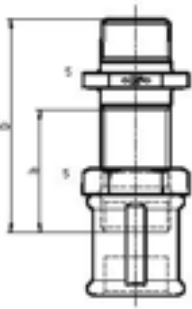

GF Malleable Fittings longcrew 536

- Longscrew socket
- Hot dip galvanised, thread electroplated.



Item No.	Item no. GF	Dimensions	l mm	Pallet/ Pack	Box/M QTY	UOM	Price per m/each
1154775	770536204	1/2 80 G	80	4320	80	pce	55,32
1154776	770536205	3/4 90 G	90	3240	60	pce	75,62
1154777	770536206	1 102 G	100	2160	40	pce	106,02
1154779	770536208	1 1/2 125 G	125	810	15	pce	214,33
1154780	770536209	2 143 G	143	540	10	pce	354,59

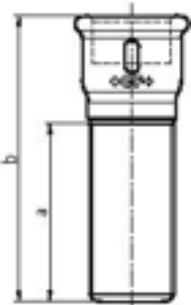

Malleable Fittings

GF Malleable Fittings longscrow 537

- Longscrew socket, complete
- * Large chamfer (gasket chamber)

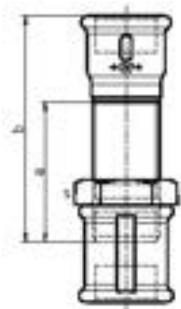

Item No.	Item no. GF	Dimensions	s mm	Pallet/ Pack	Box/M QTY	UOM	Price per m/each
1154781	770537204	1/2 80 G	32	3240	60	pce	56,92
1154782	770537205	3/4 90 G	36	1800	50	pce	70,68
1154783	770537206	1 102 G	46	1350	25	pce	103,53
1154784	770537207	1 1/4 116 G	55	1080	20	pce	171,36
1154785	770537208	1 1/2 125 G	60	540	15	pce	197,72

GF Malleable Fittings plug 595

- Plug with one machined face

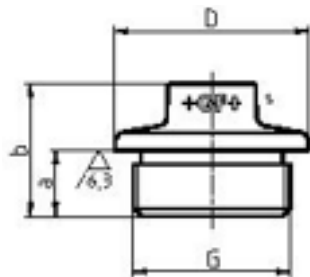

Item No.	Item no. GF	Dimensions	s mm	Pallet/ Pack	Box/M QTY	UOM	Price per m/each
1154791	770595104	1/2 B	11	100	10	pce	13,86
1154794	770595204	1/2 G	11	100	10	pce	20,97
1154792	770595105	3/4 B	17	7200	100	pce	15,49
1154795	770595205	3/4 G	17	7200	100	pce	23,36
1154793	770595106	1 B	19	50	10	pce	16,53
1154796	770595206	1 G	19	50	10	pce	25,00

Malleable Fittings

GF Malleable Fittings plug 596

- Plug, hexagon/square inside, ISO/EN T11
- 'ST' these types of fittings are made from steel (galvanised finish = electroplated)
- Not suitable for drinking water installations.

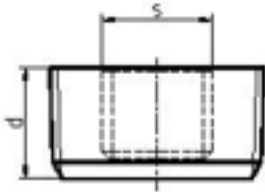

Item No.	Item no. GF	Dimensions	s mm	Pallet/ Pack	Box/M QTY	UOM	Price per m/each
1154797	770596101	1/8 STAB	5	500	10	pce	5,52
1154806	770596201	1/8 STAG	5	500	10	pce	8,36
1154798	770596102	1/4 STAB	7	500	10	pce	5,05
1154807	770596202	1/4 STAG	7	500	10	pce	7,75
1154799	770596103	3/8 STAB	8	500	10	pce	5,73
1154808	770596203	3/8 STAG	8	500	10	pce	8,83
1154800	770596104	1/2 B	10	200	10	pce	4,05
1154809	770596204	1/2 G	10	200	10	pce	6,51
1154801	770596105	3/4 B	12	150	10	pce	5,11
1154810	770596205	3/4 G	12	150	10	pce	8,11
1154802	770596106	1 B	16	150	10	pce	6,18
1154811	770596206	1 G	16	150	10	pce	9,92
1154803	770596107	1 1/4 B	22	4320	60	pce	9,10
1154812	770596207	1 1/4 G	22	4320	60	pce	15,36
1154804	770596108	1 1/2 B	22	1800	25	pce	19,75
1154813	770596208	1 1/2 G	22	1800	25	pce	33,93
1154805	770596109	2 B	27	1440	20	pce	30,32

GF Malleable Fittings stopcock spanner 901

- Stopcock spanner

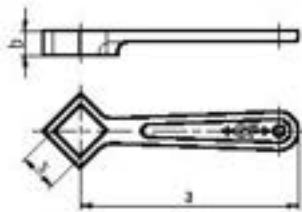

Item No.	Item no. GF	Dimensions	L mm	W mm	H mm	W kg	Pallet/ Pack	Box/M QTY	UOM	Price per m/each
1154854	770901215	10 10 G	101	25	10	0,0314	7200	100	pce	14,27

Tools

Cutting and Preparation



Cutting and Preparation



Benefits

- Reduces installation errors and leaks
- Ensures correct fitting insertion and alignment
- Improves joint reliability and durability
- Saves time during installation

The Cutting and Preparation range includes Uponor tools for cutting, deburring, bevelling and bending pipes, ensuring correct pipe geometry and clean ends before connection. Proper preparation improves joint quality and installation reliability.

Application

- Cutting MLC, PEX and plastic pipes
- Deburring and bevelling pipe ends before pressing
- Manual and guided pipe bending
- Preparation of pipes for press and expansion systems

Specification

- Compatible with MLC, PEX and plastic pipes
- Supports multiple diameter ranges
- Manual and mechanical tool options
- Designed for precise, clean pipe preparation

Uponor Multi pipe & conduit cutting tool

- Easy cutting with a special triangle blade
- Outside diameters 12-25 mm



Item No.	Dimensions	L mm	W mm	H mm	W kg	Pallet/ Pack	Box/M QTY	UOM	Price per m/each
1089674	12-25	187	65	28	0,303	36	1	pce	44,72

Uponor Multi cutting tool blade

- for Multi pipe cutting tool



Item No.	Dimensions	L mm	W mm	H mm	W kg	Pallet/ Pack	Box/M QTY	UOM	Price per m/each
1089776	12-25	39	32	2	0,019	150	1	pce	13,87

Uponor Multi pipe cutting tool

- For PEX pipes OD 32-40 mm



Item No.	Dimensions	L mm	W mm	H mm	W kg	Pallet/ Pack	Box/M QTY	UOM	Price per m/each
1089677	32-40	241	107	35	0,44	12	1	pce	46,88

Cutting and Preparation

Uponor Multi cutting tool blade

- Outside diameters 32-40 mm



Item No.	Dimensions	L mm	W mm	H mm	W kg	Pallet/ Pack	Box/M QTY	UOM	Price per m/each
1089779	32-40	100	61	3	0,073	50	1	pce	18,63

Uponor Multi pipe cutting tool

- For OD 25-63 mm



Item No.	Dimensions	L mm	W mm	H mm	W kg	Pallet/ Pack	Box/M QTY	UOM	Price per m/each
1089675	25-63	246	102	41	0,9	12	1	pce	57,94

Uponor Multi cutting tool blade

- outside diameters 25-63 mm



Item No.	Dimensions	L mm	W mm	H mm	W kg	Pallet/ Pack	Box/M QTY	UOM	Price per m/each
1089777	25-63	33.5	6.2	33.5	0,009	50	1	pce	6,59

Uponor Multi pipe cutting tool

- outside diameters 50-125 mm



Item No.	Dimensions	L mm	W mm	H mm	W kg	Pallet/ Pack	Box/M QTY	UOM	Price per m/each
1089676	50-125	345	155	46	1,62	8	1	pce	108,26

Uponor Multi cutting tool blade

- for Multi pipe cutting tool



Item No.	Dimensions	L mm	W mm	H mm	W kg	Pallet/ Pack	Box/M QTY	UOM	Price per m/each
1089778	50-125	50.8	11	50.8	0,015	50	1	pce	9,32

Uponor MLC pipe cutting

- for MLC pipes



Item No.	Dimensions	L mm	W mm	H mm	W kg	Pallet/ Pack	Box/M QTY	UOM	Price per m/each
1014334	63-110	205	330	135	3,6		1	pce	694,20

Cutting and Preparation

Uponor MLC pipe cutting tool disk

- for MLC pipes



Item No.	Dimensions	L mm	W mm	H mm	W kg	Pallet/ Pack	Box/M QTY	UOM	Price per m/each
1014320	63-110	41	41	6	0,014		1	pce	76,62

Uponor MLC bevelling tool

- For bevelling the Uponor Uni-Pipe PLUS and MLC pipes.
- Supplied with sturdy handle.



Item No.	Dimensions	L mm	W mm	H mm	W kg	Pallet/ Pack	Box/M QTY	UOM	Price per m/each
1006952	14	109	109	24	0,11	50	1	pce	22,93
1006830	16	11	25	11	0,12	50	1	pce	19,06
1015749	20	115	110	34	0,136	1200	1	pce	19,77
1015756	25	120	110	38	0,21	960	1	pce	22,73
1015762	32	110	35	115	0,2	900	1	pce	31,32

Uponor MLC bevelling tool

- for MLC pipes



Item No.	Dimensions	L mm	W mm	H mm	W kg	Pallet/ Pack	Box/M QTY	UOM	Price per m/each
1006638	40	110	40	70	0,183	600	1	pce	46,73
1015808	50	109	36	68	0,23	600	1	pce	53,14
1014339	63	110	65	70	0,24	600	1	pce	65,38
1014344	75	109	79	64	0,39	600	1	pce	78,91

Uponor MLC bevelling tool

- For bevelling the Uponor Uni-Pipe PLUS and MLC pipes.



Item No.	Dimensions	L mm	W mm	H mm	W kg	Pallet/ Pack	Box/M QTY	UOM	Price per m/each
1015739	16/20/25	104	99	29	0,13	60	1	pce	24,39

Uponor MLC deburring tool universal

- for MLC pipes



Item No.	Dimensions	L mm	W mm	H mm	W kg	Pallet/ Pack	Box/M QTY	UOM	Price per m/each
1060167	25 25 150	25	25	150	0,03	50	1	pce	21,61

Cutting and Preparation

Uponor MLC bending spring inside

- Bending spring for Uponor Uni-Pipe PLUS and MLC pipes.
- For heating pipe systems



Item No.	Dimensions	L mm	W mm	H mm	W kg	Pallet/ Pack	Box/M QTY	UOM	Price per m/each
1013727	14	620	6	8	0,175	1000	1	pce	4,44
1013729	16	600	10	10	0,21	100	1	pce	4,44
1013734	20	620	7	7	0,3304	75	1	pce	5,02
1013737	25	620	17	17	0,63	50	1	pce	7,51
1013739	32	620	25	25	0,63	40	1	pce	9,28

Uponor MLC bending spring outside

- Bending spring for Uponor Uni-Pipe PLUS and MLC pipes
- For heating and drinking water pipe systems



Item No.	Dimensions	L mm	W mm	H mm	W kg	Pallet/ Pack	Box/M QTY	UOM	Price per m/each
1006640	16	500	20	20	0,428	55	1	pce	6,29
1013792	20	500	25	25	0,5163	45	1	pce	6,96
1013794	25	500	30	30	0,646	45	1	pce	8,04

Uponor Uni Pipe PLUS bending tool

- Producing evenly formed bends in Uponor Uni-Pipe PLUS pipes with outer diameters up to 32 mm.
- Delivered complete in tool case with bending segments.



Item No.	Dimensions	L mm	W mm	H mm	W kg	Pallet/ Pack	Box/M QTY	UOM	Price per m/each
1071925	16-32	320	230	38	1,827	100	1	pce	340,29

Uponor Flex pipe cutting tool PEX

- Pipe cutting tool for Uponor flexible pipes, outside diameters 12-25 mm.
- Blades not compatible with Uponor pipe cutter 1001369



Item No.	Dimensions	L mm	W mm	H mm	W kg	Pallet/ Pack	Box/M QTY	UOM	Price per m/each
1089673	12-25	187	65	23	0,22	36	1	pce	26,63

Uponor Flex cutting tool blade PEX

- for Flex pipe cutting tool

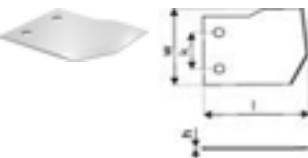

Item No.	Dimensions	L mm	W mm	H mm	W kg	Pallet/ Pack	Box/M QTY	UOM	Price per m/each
1089780	12-25	40	35.5	1	0,009	150	1	pce	14,18

Cutting and Preparation

Uponor MLC pipe cutting tool blade

- for MLC pipes



Item No.	Dimensions	L mm	W mm	H mm	W kg	Pallet/ Pack	Box/M QTY	UOM	Price per m/each
1006635	25-63	24	24	7	0,004		1	pce	4,43
1014173	50-110	45	45	11	0,014	20	1	pce	7,23

Uponor MLC pipe cutting tool blade

- for MLC pipes



Item No.	L mm	W mm	H mm	W kg	Pallet/ Pack	Box/M QTY	UOM	Price per m/each
1013721	90	70	2	0,073	10	1	pce	16,95

Uponor S-Press PLUS pressure testing plug

- Reuseable pressure test plug
- 1/2" female thread to attach [pressure test equipment

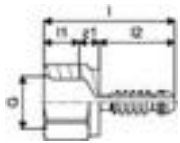

Item No.	Dimensions	G inch	l1 mm	l2 mm	l mm	z1 mm	Pallet/ Pack	Box/M QTY	UOM	Price per m/each
1013754	14	0,5	14	30	52	8	7680	20	pce	5,51
1013756	16	1/2	14	30	52	8	7680	20	pce	3,94
1013760	20	1/2	14	30	52	8	3840	20	pce	4,12
1013762	25	1/2	14	35	57	8	3840	10	pce	4,25
1013764	32	1/2	14	42	64	8	3840	10	pce	9,54
1013765	40	1/2	14	45	67	8	960	5	pce	22,98

Uponor S-Press PLUS pressure test plug O-ring

- spare sealing O-ring for pressure testing plug

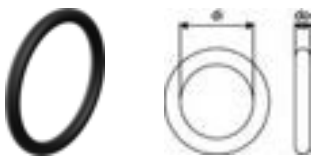

Item No.	Dimensions	di mm	do mm	Pallet/ Pack	Box/M QTY	UOM	Price per m/each
1013798	14	7,1	1,6	10000	10	pce	0,12
1013799	16	9,1	1,6	1000	10	pce	0,25
1013801	20	12	1,8	1000	10	pce	0,28
1013802	25	16	2	500	10	pce	0,32
1013803	32	21,3	2,3	500	10	pce	0,53
1013804	40	27,3	2		10	pce	0,52

Pressing



Benefits

- Fast and repeatable press connections
- Consistent joint quality independent of user
- Reduced installation time compared to threaded joints
- High safety and long-term reliability

The Pressing range includes Uponor manual and electric pressing tools, jaws, chains and accessories designed for secure, fast and repeatable press connections. The system supports a wide diameter range and enables consistent joint quality across residential and commercial installations.

Specification

- Manual and battery-powered pressing tools
- Interchangeable jaws and pressing chains
- Suitable for small to large pipe diameters
- Controlled pressing force and cycle time

Application

- Pressing of MLC press fittings
- Battery-powered or manual pressing on site
- Large-diameter pressing using chains and base units
- Pressure testing and commissioning support

Uponor S-Press manual tool w/o inserts

- For use in combination with exchangeable inserts
- Supplied in case without exchangeable inserts



Item No.	Dimensions	L mm	W mm	H mm	W kg	Pallet/ Pack	Box/M QTY	UOM	Price per m/each
1015764	14-20	505	125	27	1,8	100	1	pce	338,72

Uponor S-Press manual tool insert

- Press inserts for manual pressing tool



Item No.	Dimensions	L mm	W mm	H mm	W kg	Pallet/ Pack	Box/M QTY	UOM	Price per m/each
1015776	14	30	30	17	0,079	400	1	pce	57,79
1015777	16	30	30	16	0,072	50	1	pce	74,20
1015780	20	35	28	20	0,06	50	1	pce	74,20

Pressing

Uponor S-Press tool UP110 without jaws

- supplied in carrying case, complete with battery and charger unit
- without pressing jaws.
- Range of application up to 110 mm.

- Technical specifications:
- Quick pressing due to short pressing cycle
- Crimping force: linear thrust of approx. 32 kN
- Battery capacity: High-power Makita 3.0 Ah Li-Ion battery
- Charging time: 22 min
- Weight incl. battery: without jaw 3.5 kg
- Dimensions tool: 366 x 81 x 317 mm
- Revolving/rotatable: approx. 350° rotating pressing jaw holder



Item No.	L mm	W mm	H mm	W kg	Pallet/ Pack	Box/M QTY	UOM	Price per m/each
1083612	500	255	82	4,4	20	1	set	1 615,85

Uponor S-Press battery UP110

- Akku 18 V / 3,0 Ah, Li-Ion (54 Wh)
- Battery voltage: 18 V
- Battery capacity: 3.0 Ah
- Charging time: With SPI S-PRESS BATTERY CHARGER: 22 min
- Cell technology: Li-ion
- Weight: 0,6 kg



Item No.	L mm	W mm	H mm	W kg	Pallet/ Pack	Box/M QTY	UOM	Price per m/each
1083608	110	75	62	0,602	10	1	pce	131,70

Uponor S-Press battery charger

- Quick-charger for 18V Li-Ion batteries, 230 V
- Charging time: 1.3 Ah 15 min, 3.0 Ah 22 min
- Mains supply: 230 V AC
- Voltage range: 18 V
- Weight: 1,0 kg



Item No.	Dimensions	L mm	W mm	H mm	W kg	Pallet/ Pack	Box/M QTY	UOM	Price per m/each
1083610	Mini2, UP110	155	180	110	0,829		1	pce	138,51

Pressing

Uponor S-Press jaw UPP1

- Pressing jaws for Uponor S-Press and S-Press PLUS press fittings



Item No.	Dimensions	L mm	W mm	H mm	W kg	Pallet/ Pack	Box/M QTY	UOM	Price per m/each
1007083	14	150	105	32	1,91	280	1	pce	106,02
1007084	16	15	105	40	1,91	216	1	pce	106,02
1007086	20	150	120	30	1,9		1	pce	106,02
1007087	25	150	100	35	2,16		1	pce	110,69
1007088	32	152	105	35	2,0		1	pce	110,69
1015768	40	170	110	35	2,89	108	1	pce	188,87
1015792	50	175	118	32	2,6	108	1	pce	201,32

Uponor S-Press base unit for chain

- Base unit for the pressing chain to press Uponor MLC press fittings 63 - 110
- For use in combination with pressing tool UP 110, UP 75 and UP 75 EL



Item No.	Dimensions	L mm	W mm	H mm	W kg	Pallet/ Pack	Box/M QTY	UOM	Price per m/each
1046545	63-110	140	130	50	2,43		1	pce	320,21

Uponor S-Press chain

- Pressing chain to be used in combination with base unit
- Press Uponor MLC press fittings 63 - 110
- For use with pressing tool UP 110, UP 75 and UP 75 EL



Item No.	Dimensions	L mm	W mm	H mm	W kg	Pallet/ Pack	Box/M QTY	UOM	Price per m/each
1046541	63	125	120	58	2,297	72	1	pce	811,19
1046542	75	145	135	60	2,64	72	1	pce	824,36
1046543	90	155	155	60	3,29	72	1	pce	1 066,18
1046544	110	170	170	59	3,88	54	1	pce	1 154,23

Uponor S-Press battery Mini2

- Battery 18 V / 1.5 Ah, Li-Ion (27 Wh)
- Battery voltage: 18 V
- Battery capacity: 1.5 Ah
- Charging time: With SPI S-Press Battery Charger: 15 min
- Cell technology: Li-ion
- Weight: 0,4 kg



Item No.	L mm	W mm	H mm	W kg	Pallet/ Pack	Box/M QTY	UOM	Price per m/each
1083605	114	72	43	0,352		1	pce	136,74

Pressing

Uponor S-Press jaw Mini KSP0

- Mini KSP0 jaws for Mini 32 tool
- Uponor pressing jaws for Uponor S-Press and S-Press PLUS fittings



Item No.	Dimensions	L mm	W mm	H mm	W kg	Pallet/ Pack	Box/M QTY	UOM	Price per m/each
1007090	14	127	95	17	1,01	5	1	pce	130,08
1007091	16	125	95	17	1,02	5	1	pce	130,08
1007093	20	155	95	17	1	5	1	pce	130,08
1007094	25	125	94	16	1,017	5	1	pce	138,51
1007095	32	125	95	17	0,94	5	1	pce	138,51

Uponor S-Press tool Mini2 without jaws UK

- Uponor S-Press tool Mini² supplied in carrying case, complete with battery and charger unit.
- Pressing range of up to 32 mm.

- Technical specifications:
- Very quick pressing thanks to short pressing cycle of 3-4 seconds
- Crimping force: linear thrust of approx. 15 kN
- Battery capacity: High-power Makita 1.5 Ah Li-Ion battery (3.0 Ah optional)
- Charging time: 1.5 Ah 15 min. 3.0 Ah 22 min
- Weight incl. battery: without jaws 1.7 kg
- Dimensions tool: 377 x 75 x 116 mm
- Revolving/rotatable: approx. 350° rotating pressing jaw holder



Item No.	L mm	W mm	H mm	W kg	Pallet/ Pack	Box/M QTY	UOM	Price per m/each
1083674	355	325	78	2,6	25	1	set	1 304,30

Uponor S-Press tool case blue Mini2

- Made of plastic
- For Uponor S-Press tool Mini².
- Blue.



Item No.	L mm	W mm	H mm	W kg	Pallet/ Pack	Box/M QTY	UOM	Price per m/each
1083599	485	390	120	2,3	25	1	pce	99,40

Uponor S-Press spare battery UP75

- For the battery powered pressing machine UP 75
- Not compatible to the Ni-Cd charger unit.



Item No.	L mm	W mm	H mm	W kg	Pallet/ Pack	Box/M QTY	UOM	Price per m/each
1006949	115	80	83	0,64	12	1	pce	110,69

Pressing

Uponor S-Press battery Mini

- Battery: 9.6V for Uponor battery pressing tool Mini KSP0.



Item No.	L mm	W mm	H mm	W kg	Pallet/ Pack	Box/M QTY	UOM	Price per m/each
1015703	85	75	57	0,421		1	pce	97,09

Uponor S-Press spare charger Mini UP75

- For the re-charging battery of pressing machine UP 110 and Mini KSP0



Item No.	L mm	W mm	H mm	W kg	Pallet/ Pack	Box/M QTY	UOM	Price per m/each
1006950	190	90	80	0,476	10	1	pce	138,56

Uponor S-Press tool set A

- Tool kit consists of:
- UPONOR MLC PIPE CUTTING TOOL 25-63
- UPONOR MLC BENDING SPRING OUTSIDE 16
- UPONOR S-PRESS JAW UPP1 16
- UPONOR S-PRESS JAW UPP1 20
- UPONOR S-PRESS JAW UPP1 25
- UPONOR SPI S-PRESS TOOL CASE
- UPONOR MLC BENDING SPRING OUTSIDE 20
- UPONOR MLC BENDING SPRING OUTSIDE 25
- UPONOR MLC PIPE CUTTING TOOL 14-25
- UPONOR MULTI PIPE & CONDUIT CUTTING TOOL 12-25
- UPONOR MULTI PIPE CUTTING TOOL 25-63



Item No.	L mm	W mm	H mm	W kg	Pallet/ Pack	Box/M QTY	UOM	Price per m/each
1013782	430	200	540	17,6		1	pce	537,34

Uponor Smart Aqua pressure test plug WW

- For mounting at termination wall box during tightness test of the installation



Item No.	Dimensions	G inch	L mm	Pallet/ Pack	Box/M QTY	UOM	Price per m/each
1135499	1/2"MT	1/2	85	360	20	pce	4,17

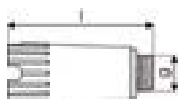

Pressing

Uponor Smart Aqua pressure test plug

- For mounting at termination wall box during tightness test of the installation



Item No.	Dimensions	G inch	l mm	Pallet/ Pack	Box/M QTY	UOM	Price per m/each
1135501	1/2"MT	1/2	85	360	20	pce	4,17

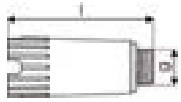

Uponor Ecoflex pressing tool

- Tool for clamping the pipe and bringing the ends together for connection
- Helps to press the fitting on the pipe ends



Item No.	In/Out	Dimensions	di mm	l mm	Pallet/ Pack	Box/M QTY	UOM	Price per m/each
1135553	01.24	125	125	1200		1	pce	479,98
1135554	01.24	140	140	1200		1	pce	494,12
1135555	01.24	160	160	1200		1	pce	512,18

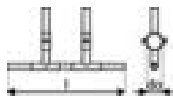

Uponor Wipex sleeve plier

- Expansion tool for the WIPEX coupling sleeve
- Used to open Wipex sleeve to allow easier assembly



Item No.	Dimensions	L mm	W mm	H mm	W kg	Pallet/ Pack	Box/M QTY	UOM	Price per m/each
1046407	1 - 1 1/2	187	15	42	0,177	25	1	pce	30,96

Expanding



Benefits

- Secure, leak-tight connections
- No O-rings or additional seals required
- Uniform joint quality
- Long service life of connections

The Expanding range provides Uponor tools for expanding plastic pipes prior to fitting insertion, ensuring tight, permanent connections without additional sealing elements. It supports fast installation with controlled expansion and reliable dimensional accuracy.

Specification

- Designed for PEX expansion systems
- Controlled expansion geometry
- Compatible with standard expansion fittings
- Manual and powered tool options

Uponor Q&E expansion tool with heads M12/

- Electromechanical driving machine, delivered in a plastic case including two 12V Li-ion rechargeable batteries and one quick charger 220-240V/50-60Hz and lubricant (Mo).
- Metal gearbox and metal housing. Incl. LED working light.
- Instruction manual in the case. Automatic rotation with M12 / M12 Rapid Seal expanding heads.
- Dim 9,9 and 16 Rapid seal heads
- Heads for 6 bar pipes in dimensions up to 32 mm.
- Heads for 10 bar pipes in dimensions up to 25 mm.

- Technical data:

- Charging voltage: 12 V
- Charge level display: Optical display
- Battery charging time: approx. 0.5 hrs.
- For dimensions: <= 32 mm (AK5/6 bar), <= 25 mm (AK2/10 bar)



Item No.	Dimensions	L mm	W mm	H mm	W kg	Pallet/ Pack	Box/M QTY	UOM	Price per m/each
1119377	16RS/20/25 6bar UK	270	215	100	3,26		1	set	394,90

Expanding

Uponor Q&E expansion tool M12 fuel

- Electromechanical driving machine
- Metal gearbox and metal housing. Incl. LED working light.
- Instruction manual in the case. Automatic rotation with M12/M 12 FUEL expanding heads.
- Technical data:
- Charging voltage: 12 V
- Charge level display: Optical display
- Battery charging time: approx. 0.5 hrs.
- For dimensions: <= 32 mm (AK5/6 bar), <= 25 mm (AK2/10 bar)



Item No.	L mm	W mm	H mm	W kg	Pallet/ Pack	Box/M QTY	UOM	Price per m/each
1121157	270	180	85	1,784		1	pce	279,22

Uponor Q&E expansion head M12/Rapid Seal

- Suitable for Q&E expanding tool M12 / M12 FUEL



Item No.	Dimensions	L mm	W mm	H mm	W kg	Pallet/ Pack	Box/M QTY	UOM	Price per m/each
1119380	9,9x1.1	50	50	67	0,223		1	pce	68,88

Uponor Q&E expansion head M12/M18

- Suitable for Q&E expanding tool M12 / M12 FUEL - M18/M18 FUEL



Item No.	Dimensions	s mm	p bar	Pallet/ Pack	Box/M QTY	UOM	Price per m/each
1057171	12x1,1/1,7/1,8/2,0	6	+10		1	pce	68,88

Uponor Q&E expansion head M12/M18/Rapid Seal

- Suitable for Q&E expander tool M12 / M12 FUEL and M18 / M18 FUEL
- Rapid Seal technology for faster water-tight connections



Item No.	Dimensions	L mm	W mm	H mm	W kg	Pallet/ Pack	Box/M QTY	UOM	Price per m/each
1119381	16x1,8/2,0/2,2	50	50	68.5	0,19		1	pce	68,88
1119382	20x1,9/2,0	48	48	69	0,202		1	pce	68,88
1119384	25x2,3	46	46	77	0,237		1	pce	68,88
1119386	32x2,9	45	45	75	0,359		1	pce	72,89

Uponor Q&E expansion tool with heads M18 6bar

- in suitcase



Item No.	Dimensions	p bar	Pallet/ Pack	Box/M QTY	UOM	Price per m/each
1063908	16/20/25/32	6		1	set	852,89
1095324	16/20/25/32 UK	335		1	set	897,60

Expanding

Uponor Q&E expansion head M18 H

- for expansion tool M18



Item No.	Dimensions	s mm	p bar	Pallet/ Pack	Box/M QTY	UOM	Price per m/each
1057183	40x3,7	3,7	6		1	pce	221,83

Uponor Q&E expansion tool M18 VLD PEX

- for Q&E pipes



Item No.	Dimensions	L mm	W mm	H mm	W kg	Pallet/ Pack	Box/M QTY	UOM	Price per m/each
1085099	40-75	700	195	535	15		1	pce	2 492,66

Uponor Q&E expansion head VLD

- for Q&E expansion tool



Item No.	Dimensions	s mm	p bar	Pallet/ Pack	Box/M QTY	UOM	Price per m/each
1085095	40x3,7/5,5	3,7/5,5	6+10		1	pce	398,57
1085096	50x4,6/6,9	4,6/6,9	6+10		1	pce	434,09
1085097	63x5,8/8,6	5,8/8,6	6+10		1	pce	398,57

Uponor Q&E expansion tool spare battery M12

- for Q&E expansion tool



Item No.	Dimensions	L mm	W mm	H mm	W kg	Pallet/ Pack	Box/M QTY	UOM	Price per m/each
1061185	4Ah	125	80	80	0,467	12	1	pce	129,94

Uponor Minitec expansion tool

- Hand expander
- Expander head for PE-Xa pipe 9.9 x 1.1 mm
- Tube of lubricant
- Case



Item No.	Dimensions	L mm	W mm	H mm	W kg	Pallet/ Pack	Box/M QTY	UOM	Price per m/each
1006247	9,9x1,1	384	99	48	0,6	11	1	set	201,55

Uponor Minitec expansion head

- For hand expander



Item No.	Dimensions	s mm	p bar	Pallet/ Pack	Box/M QTY	UOM	Price per m/each
1006250	9,9x1,1	1,1	6		1	pce	69,36

Fixing



Benefits

- Ensures stable and secure pipe installation
- Prevents pipe movement and noise
- Improves installation quality and appearance
- Supports long-term system durability

The Fixing range includes fastening and support solutions for securing Uponor pipes during installation. It ensures correct pipe positioning, spacing and stability, contributing to long-term system performance and a clean installation layout.

Application

- Fixing pipes to walls, floors or ceilings
- Securing pipes in heating and plumbing installations
- Maintaining correct pipe alignment and spacing
- Supporting pipes before and after connection

Specification

- Suitable for plastic and multilayer pipes
- Compatible with multiple pipe diameters
- Designed for wall, floor and ceiling installation
- Mechanical fixing and support solutions

Uponor Tacker stapling tool

- Full metal
- Lightweight
- For max 125 clips



Item No.	Dimensions	L mm	W mm	H mm	W kg	Pallet/ Pack	Box/M QTY	UOM	Price per m/each
1119039	14-20mm	900	230	75	2,59	50	1	pce	258,44

Uponor Siccus 14 PS cutter, groove

- Thermal cutting tool for EPS
- 230V, 50/60Hz
- With tool to cut grooves for 14mm pipes



Item No.	Dimensions	L mm	W mm	H mm	W kg	Pallet/ Pack	Box/M QTY	UOM	Price per m/each
1006290	14mm 230V	235	60	70	1,01		1	pce	169,11

Uponor Klett gloves for hauling



Item No.	Dimensions	L mm	W mm	H mm	W kg	Pallet/ Pack	Box/M QTY	UOM	Price per m/each
1048675	BLUE	250	110	15	0,087		1	pce	4,82

Uncoiling



Benefits

- Prevents kinks and pipe damage
- Improves installation ergonomics
- Faster and cleaner pipe layout
- Reduces material waste

The Uncoiling range supports controlled and safe handling of Uponor coiled pipes during installation. It helps prevent kinks, twisting and pipe damage, improving ergonomics and speeding up pipe layout on site.

Specification

- Suitable for coiled plastic and multilayer pipes
- Stable and controlled uncoiling support
- Designed for on-site installation use

Application

- Uncoiling pipes during floor or wall installation
- Straightening pipes before fixing
- Controlled pipe handling on site

Uponor MLC pipe straightening tool

- Pipe straightener is not compatible with the Uponor uncoiler
- Tool must be clamped to enable coil to be drawn through the guide rollers



Item No.	Dimensions	L mm	W mm	H mm	W kg	Pallet/ Pack	Box/M QTY	UOM	Price per m/each
1010512	14-25	230	195	77	3,2		1	pce	302,10

Uponor Magna uncoiler

- For laying of all Uponor UFHC pipes up to 25 mm.
- With telescopic adjustment, laterally flexible slide protection.
- Load-bearing capacity: max. 100 kg by full extension
- Made of galvanized steel



Item No.	l mm	h mm	w mm	Pallet/ Pack	Box/M QTY	UOM	Price per m/each
1135500	700	150	300	18	1	pce	382,68

Uponor Multi uncoiler telescope

- For laying of all Uponor UFHC pipes up to 25 mm.
- Four arms uncoiler with telescopic adjustment for save standing, laterally flexible slide protection, jump over protection, break and with adjustable pipe guide ring.
- Load-bearing capacity: max. 100 kg by full extension, max. 170 kg not extended
- Made of galvanized steel
- Weight: ca. 15 kg, partly assembled



Item No.	L mm	W mm	H mm	W kg	Pallet/ Pack	Box/M QTY	UOM	Price per m/each
1058662	228	930	255	14,65		1	pce	382,68

Others



Benefits

- Enhances overall installation efficiency
- Supports consistent installation quality
- Improves on-site usability and safety
- Complements core installation tools

The Others category groups complementary installation tools and accessories that support efficient Uponor pipe handling, system preparation and on-site workflows. These tools enhance usability, safety and overall installation quality.

Application

- Support tasks during pipe installation
- Handling and preparation assistance
- Commissioning and testing activities

Specification

- Installation-support accessories
- Compatible with multiple pipe systems
- Designed for professional use

Uponor Vario PLUS valve tool

- Tool for mounting and de-mounting the valves



Item No.	L mm	W mm	H mm	W kg	Pallet/ Pack	Box/M QTY	UOM	Price per m/each
1009216	75	30	30	0,03	10	1	pce	6,46

Uponor Ecoflex heating blanket

- Heating blanket to heat up pipe ends to help assembly during cooler weather conditions



Item No.	In/Out	Dimensions	di mm	l mm	Pallet/ Pack	Box/M QTY	UOM	Price per m/each
1135550		125	125	200		1	pce	806,44
1135551	01.24	140	140	200		1	pce	842,91
1135552	01.24	160	160	200		1	pce	866,22



Uponor - Conditions of Sale

1. Interpretation

- In these conditions–Buyer; means the company, firm, body or person buying the Goods and/or services or whose order for the Goods and/or Services is accepted by the Supplier; **Conditions** - means the terms and conditions set out in this document and include any special terms and conditions agreed in writing between the Buyer and the Supplier; any special terms shall prevail; **Contract** - means the contract for the sale of the Goods and/or Services to be provided by the Supplier pursuant to the Contract; **Goods** - mean the goods the Supplier agrees to supply; Services means the Services the Supplier agrees to supply; **Supplier** - means Uponor Limited or any other Uponor Group Company Writing includes fax, e-mail and other comparable means of communication
- 1.2 Any reference in these conditions to any provision of a statute shall be construed as a reference to that provision as amended, re-enacted or extended at the relevant time.
- 1.3 Any reference to any English legal concept or term shall, where relevant, be deemed to apply to the nearest analogous concept or term in any other jurisdiction.

2. Basis of the Sale

- 2.1 The Supplier shall sell the Goods and/or Services in accordance with any written quotation of the Supplier which is accepted by the Buyer or written order of the Buyer which is accepted by the Supplier, subject in either case to these Conditions, which shall govern the Contract to the exclusion of any other terms and conditions.
- 2.2 No variation to these Conditions shall be binding unless agreed in Writing by an authorised representative (Director / Company Secretary) of the Supplier.
- 2.3 Any typographical, clerical or other error or omission in any sales literature, quotation, price list, acceptance of offer, invoice or other document or information issued by the Supplier shall be subject to correction without any liability on the part of the Supplier.

3. Orders and Specifications

- 3.1 No order submitted by the Buyer is accepted by the Supplier unless confirmed in Writing by the Supplier's authorised representative or delivery of the Goods and/ or Services by the Supplier.
- 3.2 The Buyer is responsible for ensuring the accuracy of the terms of any order (including any applicable specification) and for giving the Supplier any necessary information relating to the Goods and/or Services within a sufficient time to enable the Supplier to perform the Contract in accordance with its terms.
- 3.3 The quantity, quality and description of and any specification for the Goods and/ or Services are those set out in the Supplier's quotation or the Buyer's order (to the extent accepted by the Supplier).
- 3.4 If the Goods are to be manufactured or any process is to be applied to the Goods by the Supplier in accordance with a specification submitted by the Buyer, the Buyer shall indemnify the Supplier against all loss, damages, costs and expenses incurred by the Supplier in connection with any claim for infringement of any patent, copyright, design, trade mark or other intellectual property rights. The Supplier gives no warranty that any Goods based on the specification of the Buyer will be fit for their intended purpose.
- 3.5 The Supplier may make any changes in the specification of the Goods and/ or Services which are required to conform to any applicable statutory or EC requirements or which do not materially affect their quality or performance.
- 3.6 No order which has been accepted by the Supplier may be cancelled by the Buyer, except with the agreement in Writing of the Supplier and on terms that the Buyer indemnifies the Supplier in full against all loss (including loss of profit), costs (including the cost of all labour and materials used), damages, charges and expenses incurred by the Supplier as a result of cancellation.
- 3.7 All drawings, designs, specifications and other information provided by the Supplier are confidential and all rights of copyright ownership and other intellectual property rights in respect of them shall remain vested in the Supplier and shall not pass to the Buyer.

4. Price of Goods

- 4.1 The price of the Goods and/or Services shall be the price specified on the Supplier's confirmation of order or, if none, the price specified in the Supplier's quotation or, if none, the Supplier's published price list current at the date of supply of the Goods and/or Services shall apply.
- 4.2 The Supplier may vary the price of the Goods and/or Services at any time before delivery to reflect any change in the cost to the Supplier which is due to any factor beyond the control of the Supplier (including, without limitation, foreign exchange fluctuation, currency regulation, increase in the costs of labour, materials or other costs of manufacture). any change in delivery dates, quantities or specifications for the Goods and/or Services which is requested by the Buyer, or any delay caused by any instructions of the Buyer or failure of the Buyer to give the Supplier adequate information or instructions.
- 4.3 All prices are given by the Supplier on an ex works basis and exclude VAT and other duties and the Buyer shall be liable to pay those duties and (subject to condition 6.6) the Supplier's charges for transport, packaging and insurance.
- 4.4 The Supplier may sue the Buyer for the price of the Goods, notwithstanding that title to them has not passed to the Buyer.

5. Terms of Payment

- 5.1 The Supplier may invoice the Buyer at any time for the price of the Goods and/or Services or part of it and, without limitation, may invoice the Buyer in respect of any instalment of an order. Unless the Supplier specifies otherwise (in writing) the Buyer shall pay the invoice (in full without any set off, deduction or counterclaim) within 30 days of the end of the calendar month in which the invoice is dated. Time of payment of the price shall be of the essence of the Contract.
- 5.2 If the Buyer fails to make any payment by the due date or the Supplier has reasonable grounds for believing that the Buyer will not make any payment then, without prejudice to any other right or remedy available to the Supplier, the Supplier may cancel the Contract or suspend any further deliveries to the Buyer.
- 5.3 If the Buyer fails to make any payment on the due date then without prejudice to any other right or remedy available to the Company the Company shall be entitled to charge the Buyer interest (both before and after any judgment) on the amount unpaid at the rate of 8% per annum above Bank of England base rate from time to time until payment is made (a part of a month being treated as a full month for the purpose of calculating interest).

6. Delivery, Returns and Performance

- 6.1 Unless otherwise agreed in writing by the parties, delivery of the Goods shall be made by the Supplier "ex works" as that term is defined in "Incoterms" -the international rules for the interpretation of trade terms of the International Chamber of Commerce sales dated 2000. A cost for delivery will be provided by the supplier to the buyer in each and every instance.
- 6.2 Any dates quoted for delivery of the Goods and/or Services are approximate only, and the Supplier shall not be liable for any delay in delivery of the Goods and/or Services.
- 6.3 If the Buyer fails to take delivery of the Goods or fails to give the Supplier adequate delivery instructions then, without prejudice to any other right or remedy available to the Supplier, the Supplier may store the Goods until actual delivery and charge the Buyer for the reasonable costs (including insurance) of storage and/or sell the Goods at the best price readily obtainable and (after deducting all reasonable storage and selling expenses) account to the Buyer for the excess over the price under the Contract or charge the Buyer for any shortfall below the price under the Contract.
- 6.4 The Buyer shall comply with all laws governing the importation of the Goods into the country of destination.
- 6.5 Minimum individual order value to include free delivery is £1000 net (or currency equivalent & excluding VAT). Please contact the supplier for any orders below this value for delivery costs. This term excludes Ecoflex pipe systems (see item 6.9 below) and any other items not included within our price guide.
- 6.6 Delivery of the goods that are requested direct to site or another third party address, will be subject to additional surcharges over and above delivery costs.
- 6.7 Where a next day service is required, customers should contact the supplier for a delivery charge quotation for each and every order.
- 6.8 For deliveries of Ecoflex pipe systems, no returns are allowed and the buyer needs to request a delivery cost from the supplier for each and every order
- 6.9 Retention to title: Goods remain the property of Uponor Limited until paid for in full. Any query regarding this delivery should be notified in writing to Uponor Limited within 3 working days of receipt of the goods. As signed for proof of delivery (from whomever signs) will be deemed as acceptance of the goods as listed and in good condition.
- 6.10 No returns will be allowed without prior approval from the supplier.
- 6.11 All prices are based on ex-works Worcester. UK and delivery costs will be additional to prices quoted.

7. Risk and Property

- 7.1 Risk of damage to or loss of the Goods shall pass to the Buyer at the time of delivery or, if the Buyer wrongfully fails to take delivery the time when the Supplier has tendered delivery of the Goods. The Buyer should insure the Goods accordingly.
- 7.2 Notwithstanding delivery and the passing of risk in the Goods, or any other provision of these Conditions, the property in the Goods shall not pass to the Buyer until the Supplier has received in cash or cleared funds payment in full of the price of the Goods and all other goods and services agreed to be sold by the Supplier to the Buyer for which payment is then due.
- 7.3 Until such time as the property in the Goods passes to the Buyer, the Buyer shall hold the Goods as the Supplier's fiduciary agent and bailee, and shall keep the Goods separate from those of the Buyer and third parties and properly stored, protected and insured and identified as the Supplier's property, and shall not be entitled to dispose of the Goods.
- 7.4 Until such time as the property in the Goods passes to the Buyer, the Supplier may at any time require the Buyer to deliver up the Goods to the Supplier and, if the Buyer fails to do so forthwith, enter upon any premises of the Buyer or any third party where the Goods are stored and repossess the Goods.

Uponor - Conditions of Sale

8. Warranties and Liability

Warranties

- 8.1 Subject to the conditions set out below, the Supplier warrants that the Goods will correspond with their specification at the time of delivery and will be free from defects in material and workmanship for a period of 12 months from purchase (with accompanying proof of purchase).
- 8.2 This warranty is given by the Supplier subject to the following conditions:
- 8.2.1 the Supplier shall be under no liability in respect of any defect arising from any drawing, design or specification supplied by the Buyer;
- 8.2.2 the Supplier shall be under no liability in respect of any defect arising from fair wear and tear, wilful damage, negligence, abnormal working conditions, failure to follow the Supplier's instructions (whether oral or in Writing), misuse or alteration or repair of the Goods without the Supplier's approval;
- 8.2.3 this warranty does not extend to parts, materials or equipment not manufactured by the Supplier, in respect of which the Buyer shall only be entitled to the benefit of any such warranty or guarantee as is given by the manufacturer to the Supplier.
- 8.3 Subject as expressly provided in these Conditions, all warranties, conditions or other terms implied by statute or common law are excluded to the fullest extent permitted by law. Without limitation, the Supplier does not warrant the accuracy or otherwise of any design, drawing, specification, instructions, other information or advice that it provides as part of the Services and/or as ancillary information in relation to the Goods.
- 8.4 Any claim by the Buyer which is based on any defect in the quality or condition of the Goods or their failure to correspond with specification shall be notified in writing to the Supplier within 7 days of delivery or (where the defect or failure was not apparent on reasonable inspection) within a reasonable time after discovery of the defect or failure, but, in any event, within 12 months of purchase (with accompanying proof of purchase). If delivery is not refused, and the Buyer does not notify the Supplier accordingly, the Buyer may not reject the Goods and the Supplier shall have no liability and the Buyer shall pay the price as if the Goods had been delivered in accordance with the Contract.
- 8.5 Where any valid claim is made in accordance with this Clause 8, the Supplier may replace or repair the Goods (or the part in question) or re-supply the Services (or the part in question) free of charge or, at the Supplier's sole discretion, refund to the Buyer the price of the Goods or Services (or part of it), but the Supplier shall have no further liability to the Buyer.

General Liability

- 8.6 Notwithstanding anything else in this Contract, neither party's liability in respect of death or personal injury caused by that party's negligence shall be limited.
- 8.7 The Supplier shall not be liable to the Buyer for loss of contracts, profits, anticipated savings, revenue, business, stoppage to other work or indirect or consequential loss (whether caused by the negligence of the Supplier, its employees or agents or otherwise) in connection with this Contract.
- 8.8 Notwithstanding any other provision in the Contract except Condition 8.5, the entire liability of the Supplier under or in connection with the Contract shall not exceed the sum paid to the Supplier by the Buyer for the Goods or the Services (or both, where both Goods and Services are to be supplied) which are the subject of the claim in question by the Buyer.
- 8.9 The Supplier shall not be liable for any breach of its obligations to the extent that the Supplier is prevented or hindered from complying with them by "Force Majeure".
- 8.10 "Force Majeure" means any cause beyond the reasonable control of the Supplier including (without limitation) strikes, lock-outs, labour.

9. Insolvency of Buyer

- 9.1 Without prejudice to any other right or remedy available to the Supplier, the Supplier may cancel the Contract or suspend any further deliveries without any liability to the Buyer, if:
- 9.1.1 the Buyer is unable to pay its debts, makes any voluntary arrangement with its creditors or (being an individual or firm) becomes bankrupt or (being a company) becomes subject to an administration order or goes into liquidation; or
- 9.1.2 an encumbrancer takes possession, or a receiver is appointed, of any of the property or assets of the Buyer; or
- 9.1.3 the Buyer ceases, or threatens to cease, to carry on business; or
- 9.1.4 the Supplier reasonably believes that any of the foregoing events is about to occur in relation to the Buyer and notifies the Buyer accordingly.
- 9.2 If the Goods and/or Services have been delivered but not paid for and the Supplier cancels the Contract under Conditions 5.2 and/or 9, the price shall become immediately due and payable notwithstanding any previous agreement or arrangement to the contrary.

10. Non-standard Orders

- 10.1 Where the Buyer orders Goods or materials of a type, size or quality not normally produced by the Supplier or Services not normally performed by the Supplier, the Supplier shall use all reasonable endeavours to execute the order but, without prejudice to any other provision limiting the Supplier's liability, if it proves impossible, impracticable or uneconomical to carry out or complete the order, the Supplier may cancel the Contract or the uncompleted balance of it without penalty and the Buyer shall only be liable to pay for the part of it actually delivered or performed.

11. Export Sales

- 11.1 Subject to Condition 6.1, where Goods are sold on the basis of international trade terms, they shall be defined in accordance with "Incoterms" -the international rules for the interpretation of trade terms of the International Chamber of Commerce sales dated 2000.
- 11.2 Where Goods are sold FOB, the Supplier shall not be required to give the Buyer the notice specified in Section 32(3) of the Sale of Goods Act 1979.
- 11.3 Unless otherwise agreed by the Supplier in Writing, the price of the Goods and/ or Services shall be secured by an irrevocable letter of credit satisfactory to the Supplier and established by the Buyer in favour of the Supplier immediately upon receipt of the Supplier's confirmation of order form and confirmed by a United Kingdom bank acceptable to the Supplier. The letter of credit shall be for the price payable plus any duties and taxes payable to the Supplier and shall be valid for the longer of six (6) months or any period estimated by the Supplier for delivery of the Goods and/or Services.

12. Packing

- 12.1 Unless otherwise agreed in Writing by the parties, the price specified by the Supplier excludes the cost of packing cases and packing materials, for which the Buyer shall be additionally liable. If the Supplier notifies the Buyer that packing cases and/or materials are returnable, then the full cost of these is payable by the Buyer if the Buyer does not return them in good condition to the Supplier either (at the Supplier's option) carriage paid or in the Supplier's vehicle within three (3) months of their delivery to the Buyer. Where not returnable, the Buyer will dispose of all packing in accordance with the regulations (whether statutory or otherwise) relating to the protection of the environment.
- 12.2 The Supplier shall use all reasonable endeavours to ensure, where necessary, the appropriateness of packing before despatch, but the Supplier shall not be liable for any damage to or loss of Goods between despatch from the Supplier and delivery in accordance with this Contract.

13. General

- 13.1 The Supplier may perform any of its obligations or exercise any of its rights under this Contract through any other member of its group.
- 13.2 The Buyer may not assign any of its rights or obligations or mortgage, charge (otherwise than by floating charge) any of its rights under this Agreement without the prior written consent of the Supplier.
- 13.3 Each party acknowledges that, in entering into this Contract, it does not do so on the basis of and does not rely on any representation, warranty or other provision except as expressly provided in this Contract and all conditions, warranties or other terms implied by statute or common law are excluded. This condition shall only apply to the extent permitted by law.
- 13.4 Any notice required or permitted to be given by either party to the other shall be in Writing addressed to that other party at its registered office or principal place of business or such other address as may at the relevant time have been notified pursuant to this provision to the party giving the notice.
- 13.5 No waiver by the Supplier of any breach of the Contract by the Buyer shall be considered as a waiver of any subsequent breach of the same or any other provision.
- 13.6 If any provision of the Contract is held by any competent authority in UK law to be invalid or unenforceable in whole or in part the validity of the other provisions of the Contract and the remainder of the provision in question shall not be affected.
- 13.7 A person who is not a party to the Contract has no rights under the Contracts (Rights of Third Parties) Act 1999 to enforce any term of the Contract.
- 13.8 The Contract shall be governed by and construed in accordance with the laws of England, and the parties submit to the non-exclusive jurisdiction of the English courts.
- 13.9 When supplied as B2B EEE the producer invokes regulation 9.2 and passes all WEEE obligations to the end user.

Uponor Limited ("Uponor") guarantees [to the original purchaser/customer] that pipes and fittings sold by it are free of defects in materials or manufacture under normal conditions of use for a period of 25 years and in case of electrical and mechanical products for 2 years from the date of installation. This guarantee only applies to the products stored, installed, tested and operated in accordance with the fitting instructions issued by Uponor and valid at the time the products were installed.

Where a claim is made during the guarantee period and products are proven to be defective in materials and/or manufacture at the time of delivery. Uponor will supply replacement products free of charge. This is the exclusive remedy under this guarantee.

Uponor disclaims any warranty or guarantee not expressly provided for herein, including any implied warranties of merchantability or fitness for a particular purpose. Uponor further disclaims any and all responsibility or liability for losses, damages and expenses, including special, direct, indirect, incidental and consequential damages, whether foreseeable or not, including without limitation any loss of time or use or any inconvenience arising from the ownership, installation or use of the products sold hereunder.

This guarantee does not affect the statutory rights of the consumer.

Copyright © Uponor (Uponor Limited.)

Reproduction of any part of this publication for any purpose is not permitted without the prior written permission of Uponor Limited.

The contents of this brochure are provided for guideline only. Please consult our technical manuals for full up-to-date information.

Uponor reserves the right to alter specifications and operating parameters for all their Underfloor Heating and Plumbing & Heating Systems at any time as part of its policy of continuous product development.

Care has been taken to ensure that the information in this price guide is correct at the time of going to press. Uponor Limited reserve the right to alter prices and the details of designs and performance of products without notice. E&OE.

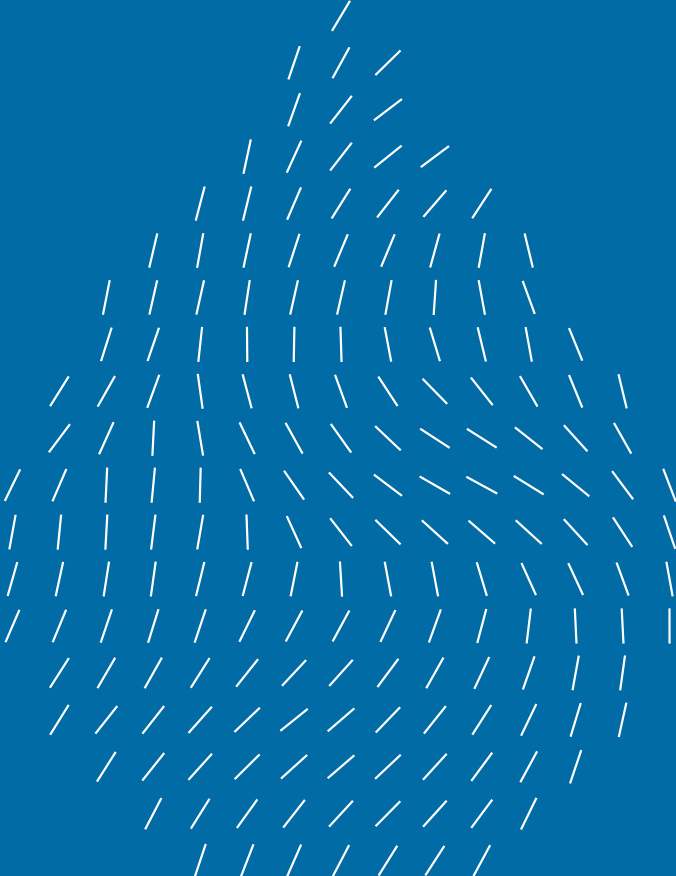

The Pavilion
Blackmoor Lane
Watford
Hertfordshire
WD18 8GA

T 01923 381212
E customerservice.uk@uponor.com
W www.uponor.com

GF Building Flow Solutions, a division of GF,
is a leading global provider of sustainable and
innovative solutions, making water flow in buildings.

