

# Uponor Smatrix Actuator Retrofit Compatibility

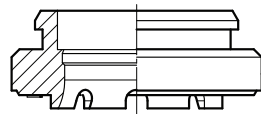

**VA 26**

**Giacomini** (is standard by LK),  
**LK** manifolds

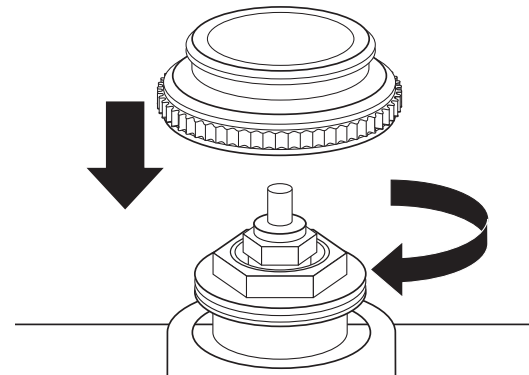
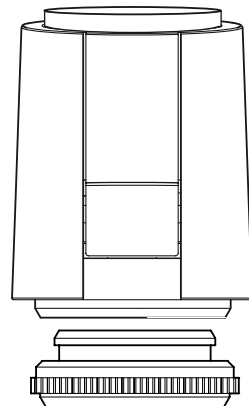
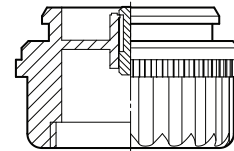

**VA 16 H**  
M28x1.5 mm

**Herz:**  
Thermostatic Valve series 'TS 98 V',  
FB – Stangenverteiler,  
3-way-valve type 'Calis TS RD'  
Control Valve type 'TS 99 FV' (H)  
Control Valve type 'TS V'

**Buderus,**  
**KAN-Therm** (brass),  
**Polytherm** (H),  
**Thermoval**

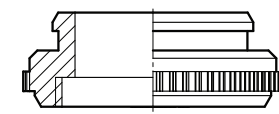

**VA 50**  
M30x1.5 mm

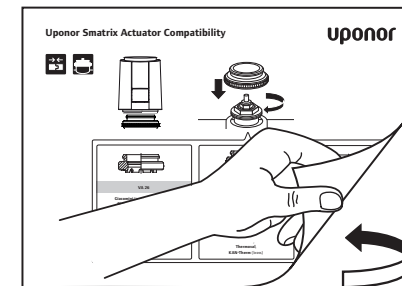

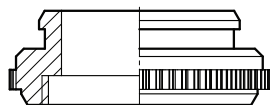
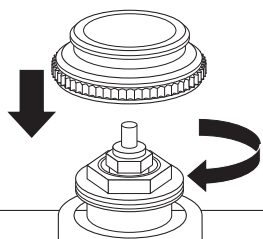

**VA 50**  
M30x1.5 mm

**Uponor:**

**Cronatherm:** EV-I 1993–2004, DV-I 1994–2004  
**Polytherm:** Stainless steel 2005–2013  
**Unicor Unipipe** Brass series MF, F, FBH 1997–2001  
**Uponor** all ECO Stainless steel manifolds, Profi brass manifolds > 2004, Stainless steel > 2008

**Acome** (Strawa); **Afriso** pro Calida EF1 (plastic);  
**Aquatechnik** Italy (Multirapid, < 2007, > 2009);  
**Aquatherm** (brass); **Artiga**, **Athe-Therm** (Stainless Steel); **Athe-Therm** (Brass > 02/2005); **Athe-Therm** (Brass > 02/2005); **ATS** Stainless Steel; **Bell & Gossett** (Zone-valve); **Beulco** (> 2005); **BHS**; **Bianchi** 4-way-valve, 662 (1-way), 663 & 664 (3-way); **Bianchi** Brass (Series 332T, 401T, 403T); **Böhnisch/SBK** (> 1998), **Broen** (Ballorex Dynamic); **Brugmann**; **Caleffi** (with threads) & Series 670 (plastic); **Cazzaniga**; **Chemidro**; **Comap** HKV Modul (H); **Cosmo** (Objekt-Line) + (CMV manifold); **CronaTech**; **Cufix**; **Cuprotherm**;

**Delphis-Therm**; **Dumser**; **Emcal** (Stainless Steel > 03/2013); **Emmeti**; **EQ-Therm** FAR (> 2007); **Formare** (No. 80); **Frank** (> 2003); **Fränkische**; **Frasa**; **Frese** Optima (2,5 mm & 4,5 mm); **Gampper** (Typ: Vario C); **GC-Verteiler**; **Gomacal**; **Heimeier**; **Herb**; **Herz** (1 7762 xx, 1 7763 xx, 1 7760 xx, Series 'TS 98 VH'); **Hesag**/Herb (Verteiler Profi-Line); **Honeywell & Braukmann**; **Honeywell** (H) (Typ: V9050), V2020 (MNG), VSMF; **IVAR**; **Jaga**; **Johnson Controls** VG6210EC, VG6510EC, V5210KC, V5510KC; **Jupiter**; **KaMo** > 09/2005, Inox; **KAN-Therm** (Stainless Steel); **Kermi**; **KWH Pipe**; **Landis & Gyr**; **Luxor** CD; **Mair** (> 1998); **Multibeton** HKV (Strawa), > 1997; **Multiblock**; **Nereus** (Valves DN 10, DN20); **Onda**; **Oventrop** (Cocon, Cocon 4, Hycocon TM (DN25), Tri-D, Tri-M, QTZ, Q, uni LH, V3K; Stainless Steel, Hycocon TM (DN32); **Pantherm**; **Prandelli** HKV; **Purmo**; **RBM**; **RDZ** Brass; **Reich**; **Reliance** Stainless Steel; **Remo**;

**Roth** DE (H) (Typ: Universal HK2); **SAS** Brass; **Sauter** BUT010 F400, BUT015 F210, BUT010 F410, VUT010 F200, F210, F220, VUT015 F210, VUL010 F330 & F340, VXL F200, F210, BXL F200 & F210, VXL F220, BUT015 F410; **Schlösser** (> 1993); **Schütz**; **Seppelfricke**; **sht Siegmund**; **Siemens** (Landis & Steafa) VPD 115A, VD 115CLC, VDN 215, VPI46, VPP46, VVI46, VXI46, VVP47, VXP47, VMP47; **Simplex**; **SKV**; **Spartan** V240; **Strasshofer**; **Strawa**; **Taco** (Vogel & Noot, Cosmo Stainless Steel); **TECE** Plastic, Stainless Steel (Strawa); **Thermotech** SE; **Therموال**; **Thermtec**; **Tiemme** Series 'Floor' TKM; **Tour & Andersson** (> 1999), TBV-CM, TBV-CMP; **Valvex** Brass; **Vescal** (Metaplast); **Viega** Stainless Steel Fonterra, pro Radiant; **VIR** Series 9520; **Vogel & Noot** (Cosmo Brassverteiler); **Watts** (HKV-T, Vogel & Noot, Cosmo Objektline Finimetall, Myson); **Wieland**; **Wittingsthal**; **Zehnder**