

Uponor Fluvia Move Pumpgroup PUSH-23-A-AC

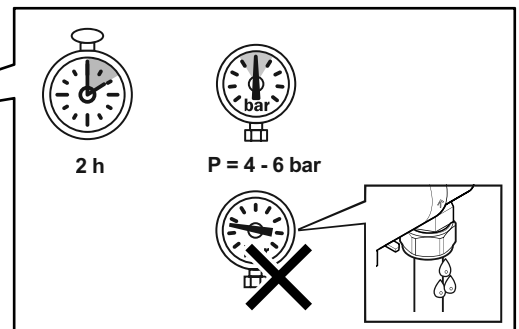

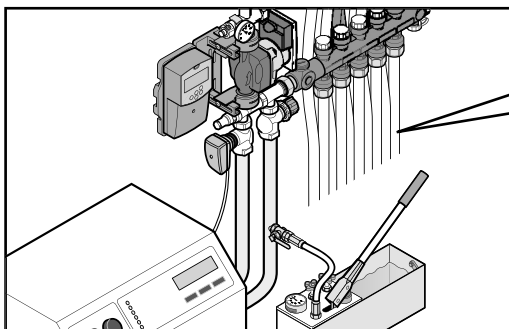
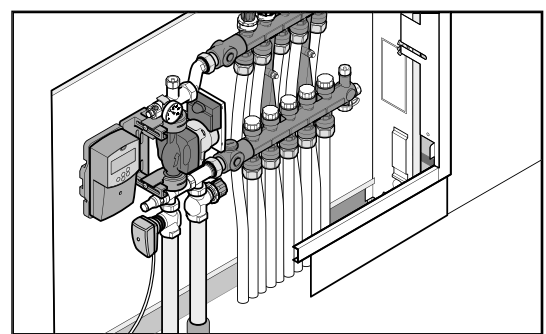
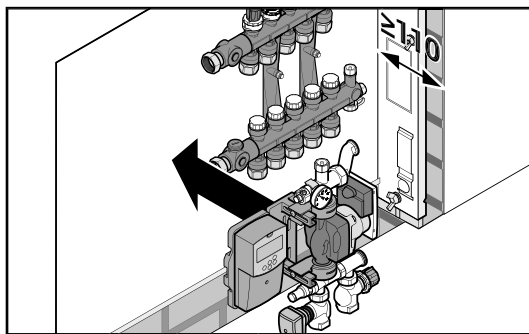
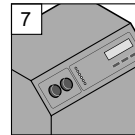
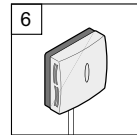
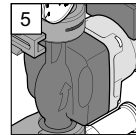
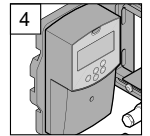
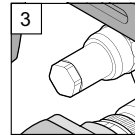
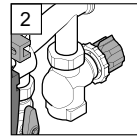
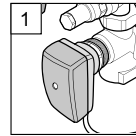
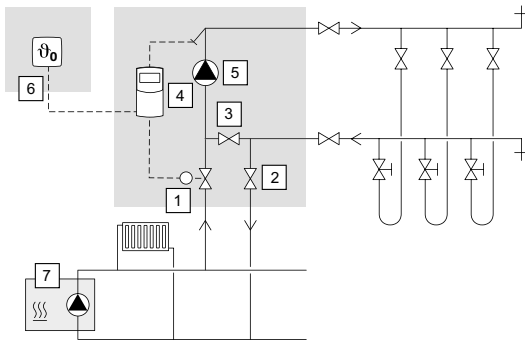
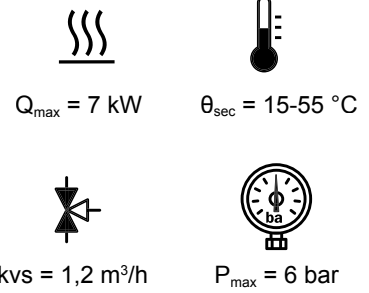
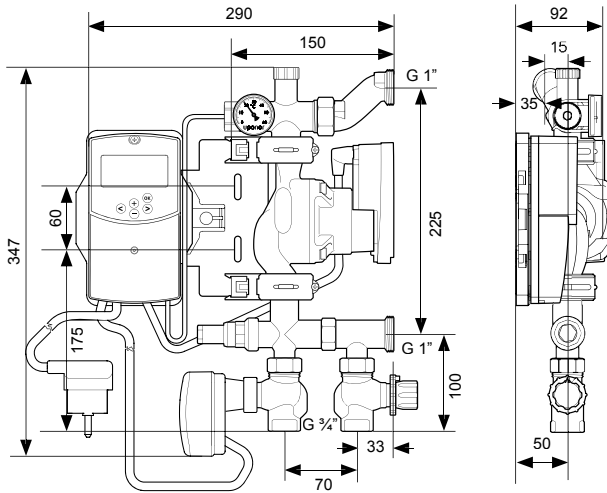
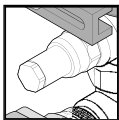
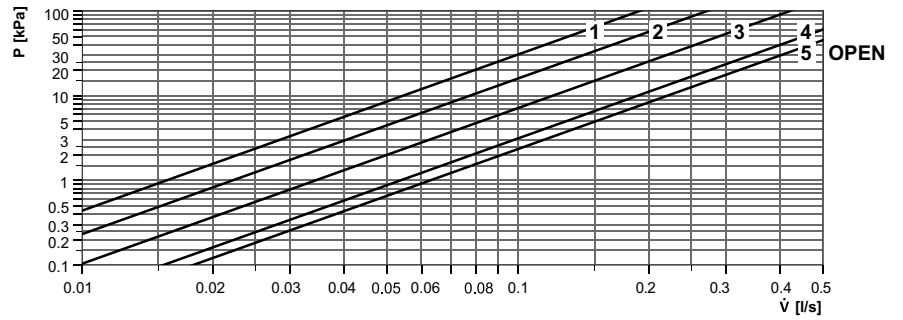
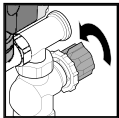
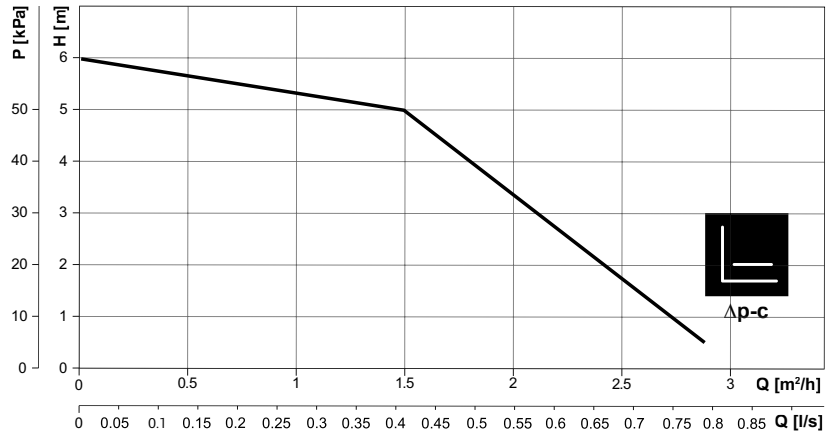
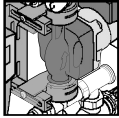

A
OPEN = Standard

B
CLOSE = Flush

C
CLOSE 100%
0

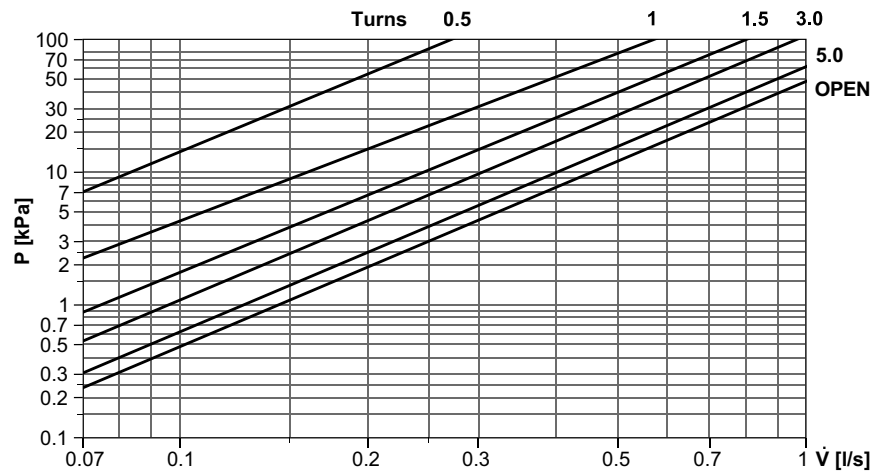

Uponor Vario PLUS manifold

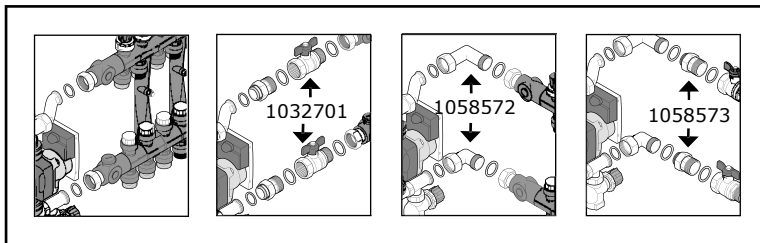

Uponor Vario B manifold

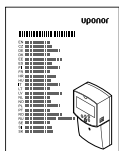
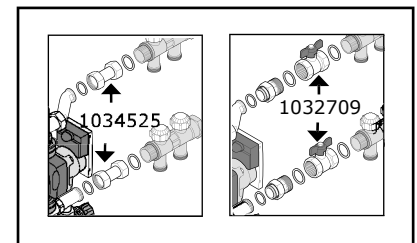

Uponor Corporation

1085121 10_2015_EN
Production: Uponor AB, EL, Virsbo; SE

Uponor reserves the right to make changes, without prior notification, to the specification of incorporated components in line with its policy of continuous improvement and development.



www.uponor.com