

Uponor Fluvia T pumpgroup Push-12

EN Technical information



Table of contents

1	Safe and easy water temperature control.....	3
1.1	Underfloor heating in individual rooms.....	3
1.2	Flexible heating solution.....	3
1.3	Advantages.....	3
1.4	Components.....	4
1.5	Temperature regulation.....	5
2	Uponor Fluvia T pumpgroup Push-12 at a glance.....	6
2.1	Heating capacity.....	6
3	Technical information.....	7
3.1	Measurements.....	7
3.2	Technical data.....	8
3.3	Diagrams.....	9

1 Safe and easy water temperature control

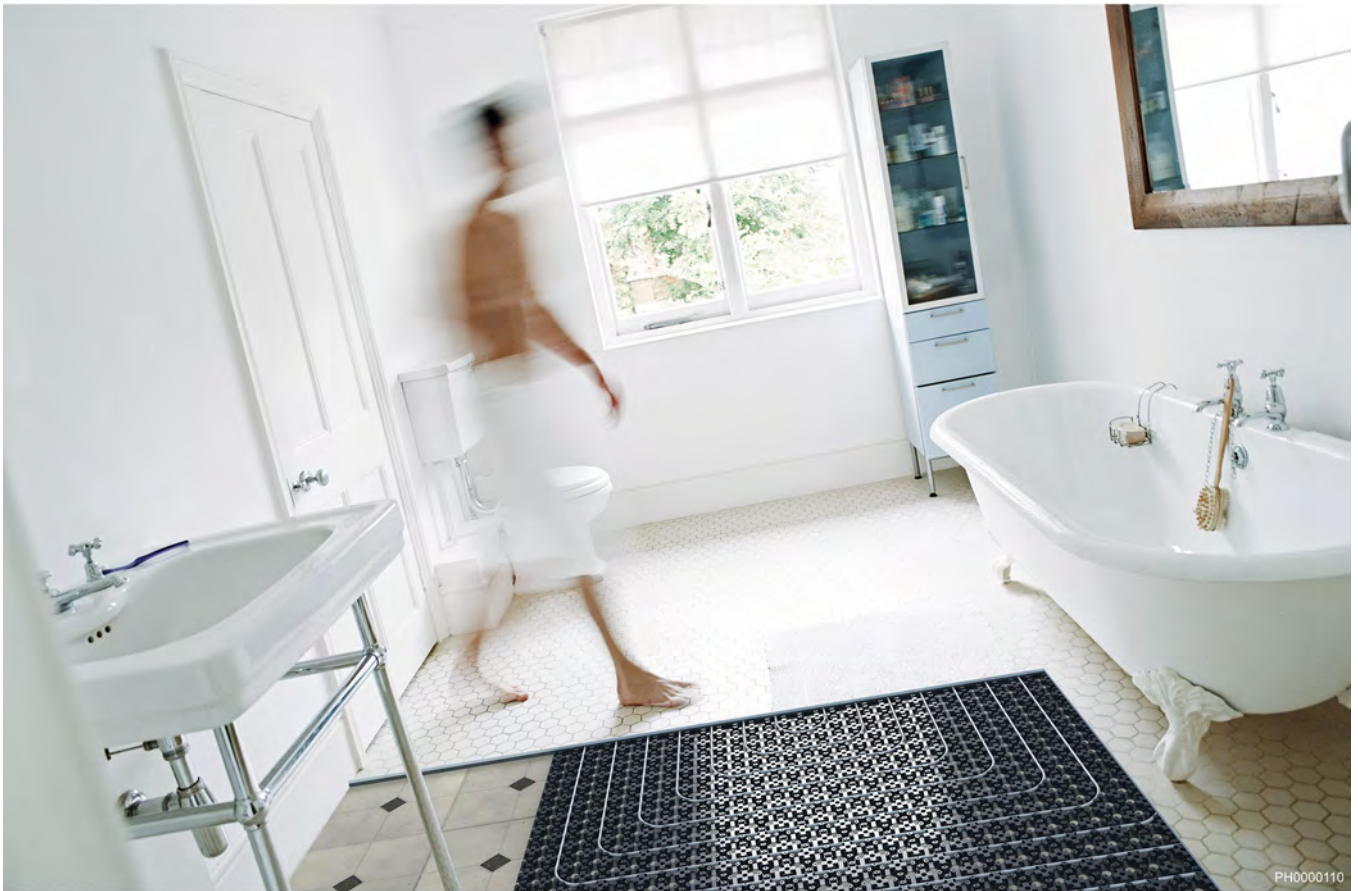

1.1 Underfloor heating in individual rooms

Uponor offers a wide variety of supply temperature control units that are fast and easy to install. They reduce energy consumption and optimise energy efficiency.

The Uponor Fluvia T pumpgroup Push-12 is a control unit specially designed for small areas of underfloor heating in individual rooms.

1.2 Flexible heating solution

The Uponor Fluvia T pumpgroup Push-12 is used for hydronic heating. It controls room temperature and at the same time prevents inadmissibly high water temperatures in the floor construction.

It is ideal for underfloor heating in relatively small areas - single rooms of approx. 6-30 m² - and designed to connect directly to existing radiator systems, for example during renovation work.

Supply water temperature is maintained at levels that are safe for the floor construction and that suit the requirements of the room. For optimal room temperature regulation several versions are available: with thermostat, wired or wireless.

1.3 Advantages

- Pump group for one room of around 30 m² maximum
- Three control types: with thermostat, wired or wireless
- Limiter for floor/water temperature ensuring protection of floor construction
- Insulation included

1.4 Components



Uponor Fluvia T pumpgroup Push-12 TH-G with thermostat



Uponor Fluvia T pumpgroup Push-12 AC-G with actuator



Uponor Fluvia T pumpgroup Push-12 WL-G with wireless control

System accessories

The Uponor Fluvia T pumpgroup Push-12 can be used for a single pipe - or a two pipe heating system: two-port branch connectors are available enabling the extension to two heating loops.



RP0000040

1034416 Uponor Fluvia branch with valve 2x G $\frac{3}{4}$ "



PF0000112

1005675 Uponor Fluvia Y compression adapter 2x G $\frac{3}{4}$ " - $\frac{3}{4}$ "

For faster filling and venting, valves are available as an additional option. These are recommended in particular for use with wall heating.



PH0000113

1061802 Uponor Vario fill and drain valve $\frac{3}{4}$ " - $\frac{3}{4}$ "

1.5 Temperature regulation

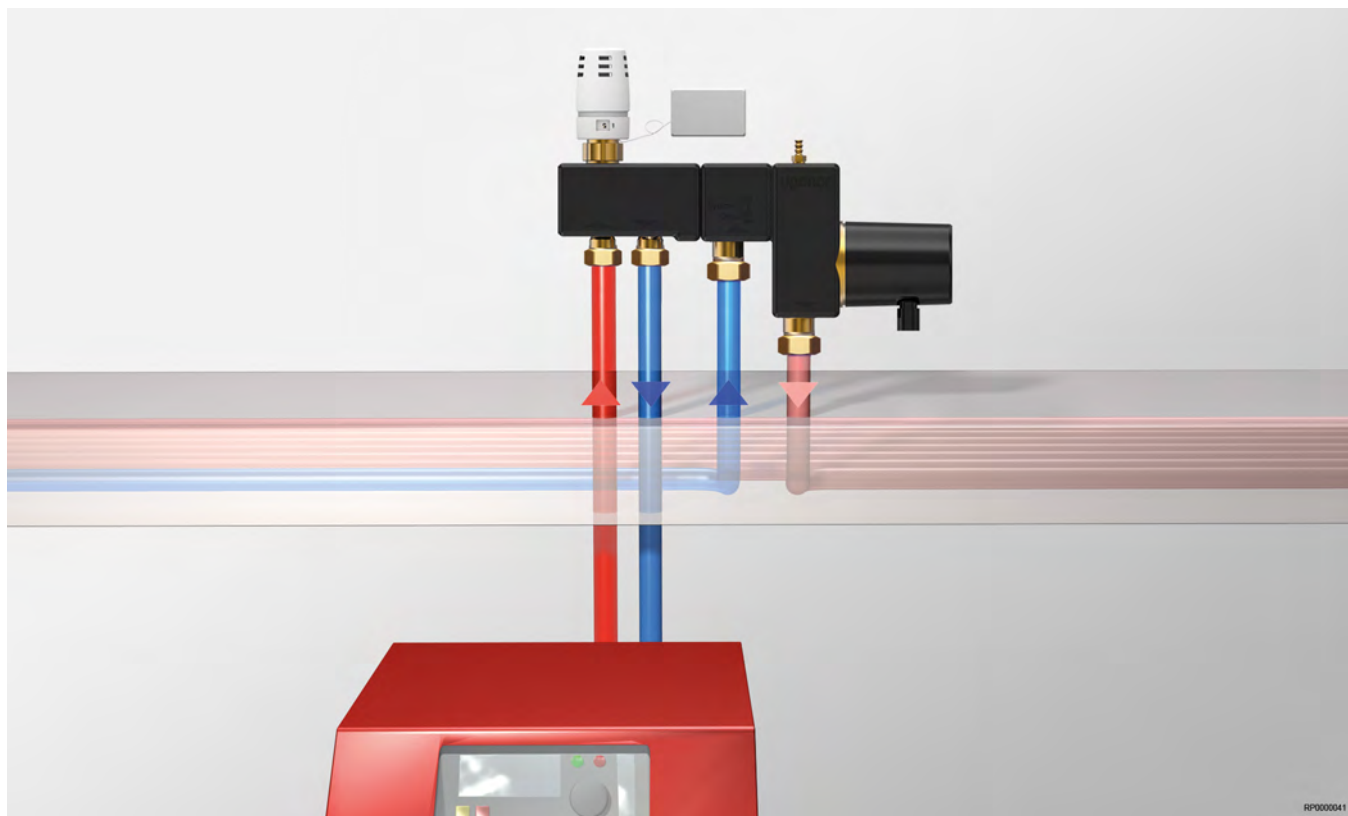

Temperature regulation by the Uponor Fluvia T pumpgroup Push-12.

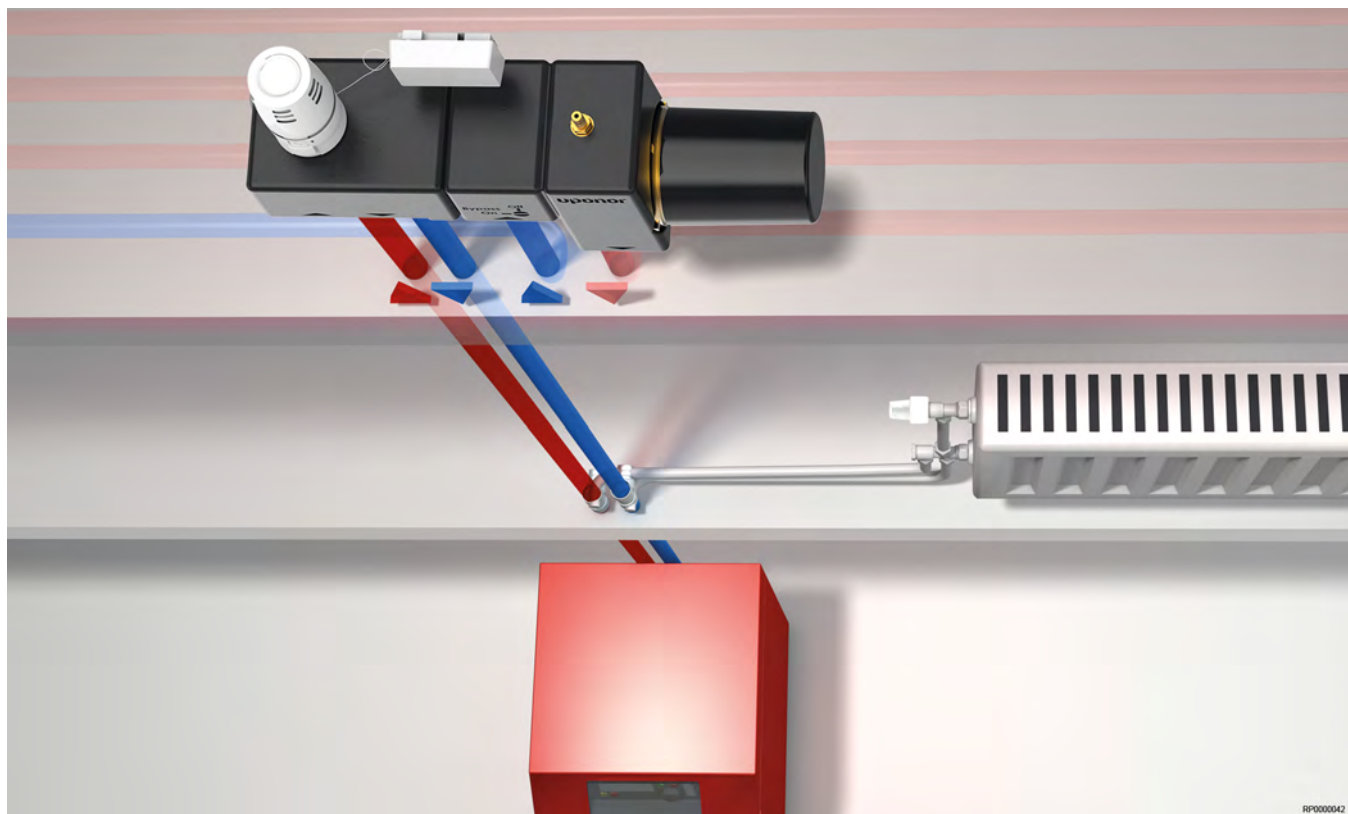

2 Uponor Fluvia T pumpgroup Push-12 at a glance

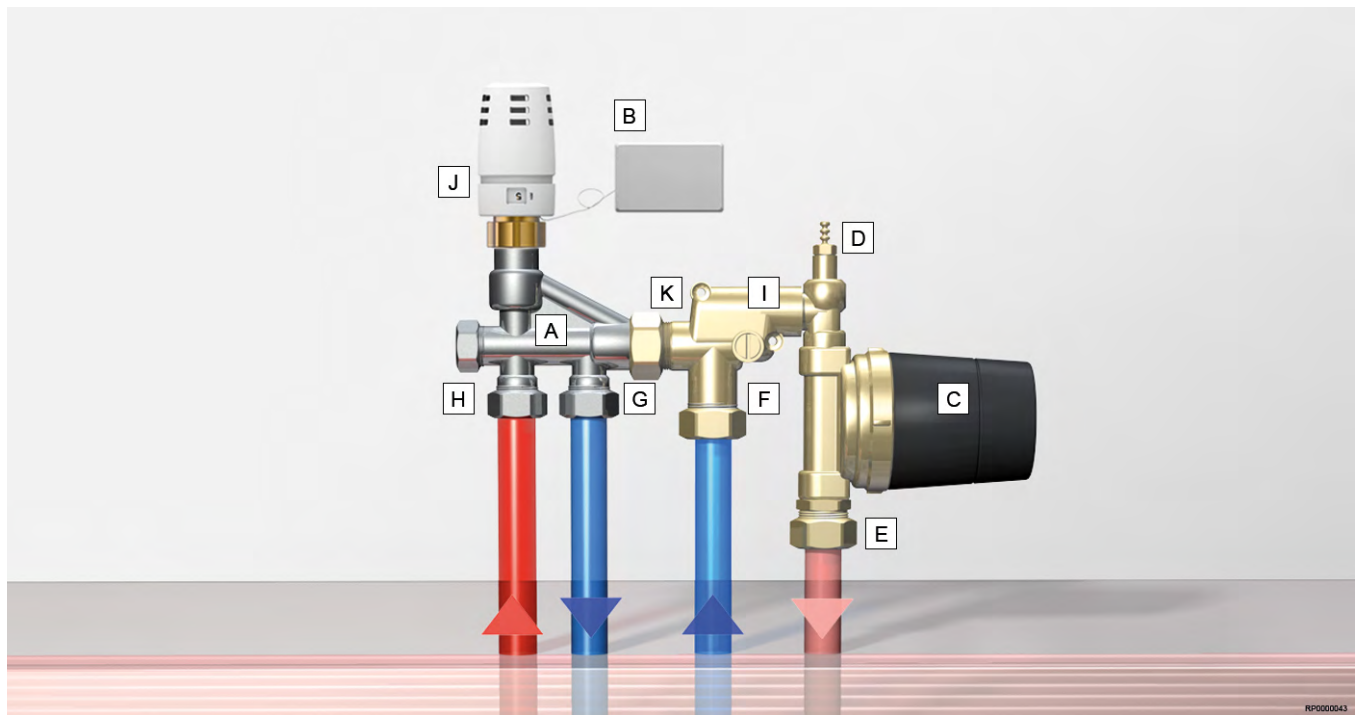

- A Valve
- B Room temperature sensor
- C Pump
- D Air vent valve
- E Supply floor heating
- F Return floor heating
- G Return primary
- H Supply primary
- I Mixing channel
- J Thermostat with capillary 2 m
- K Supply temperature limiter

2.1 Heating capacity

Heating capacity [kW]	1	1.4	1.8	2.2	2.8	3.2
Area [m ²] (loops)	12 (2 x 6 m ²)	14 (2 x 7 m ²)	18 (2 x 9 m ²)	22 (2 x 11 m ²)	28 (2 x 14 m ²)	32 (2 x 16 m ²)
Pipe dimension [mm]	9.9	12	14	16	17	20

3 Technical information

3.1 Measurements

A few measurements given for the Uponor Fluvia T pumpgroup Push-12 variants.

Uponor Fluvia T pumpgroup Push-12 TH-G

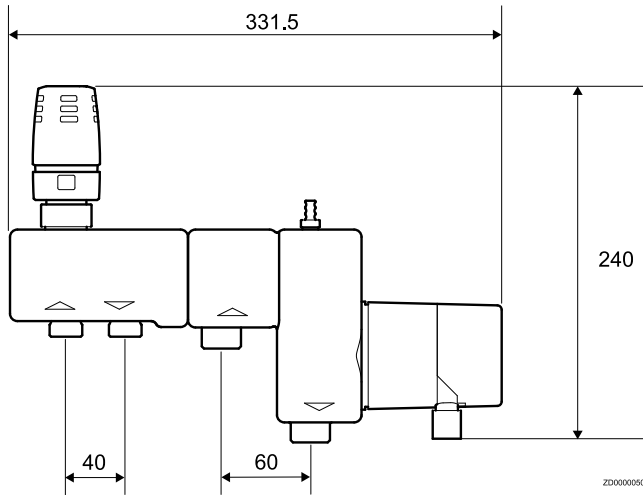

Uponor Fluvia T pumpgroup Push-12 AC-G

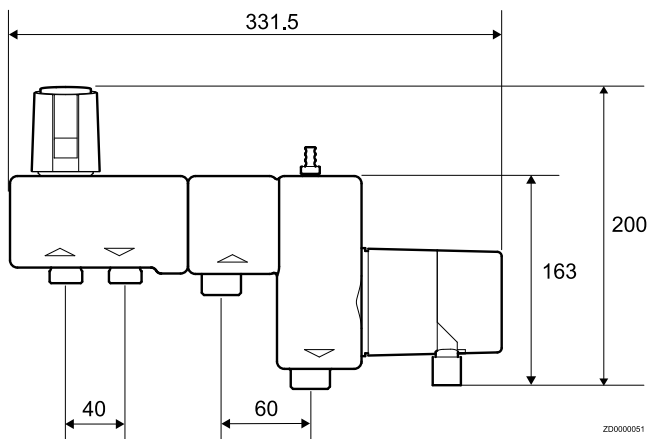

Uponor Fluvia T pumpgroup Push-12 WL-G

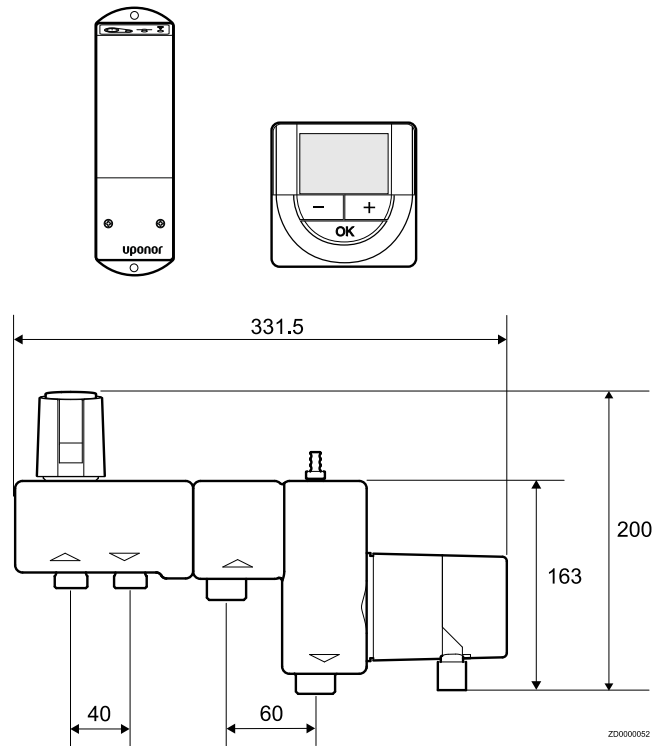

Uponor Fluvia T pumpgroup Push-12 WL-G

Thermostat	Wireless
Control range room temperature	5 - 37 °C
Programs	9 preset and 4 variable setback programs
Thermostat colour	White RAL 9003

3.2 Technical data

Uponor Fluvia T pumpgroup Push-12 (TH-G/AC-G/WL-G)	
Pump type	Grundfos Comfort 15-14 B PM 230 V, P < 1W, P _{el} < 10 W
Statical pressure max.	1 MPa/10 bar
Primary temperature max.	90 °C
Differential pressure at valve	Max. 20 kPa with opened valve, max. 100 kPa with closed valve
Control range thermostat	12 - 28 °C
Limiter of water temperature	50 °C (integrated, for secondary loops)
Connector, primary	Clamp ring fitting for copper 15 mm, included
Connector, secondary	G $\frac{3}{4}$ " Eurocone
Control valve	Compatibility with Uponor thermostat and actuator (included, depending on type)
Sound pressure level pump	< 43 dB (A), Check if installation is planned in quiet rooms such as bedrooms, if necessary the Uponor Fluvia T Push-12 should be fitted outside the room itself
Power connection	External power switch for the pump necessary
Protection code	IP44 Class F
Item number	1095127 Uponor Fluvia T pumpgroup Push-12 TH-G 1095128 Uponor Fluvia T pumpgroup Push-12 AC-G 1095129 Uponor Fluvia T pumpgroup Push-12 AC-G60 1095130 Uponor Fluvia T pumpgroup Push-12 WL-G 1095131 Uponor Fluvia T pumpgroup Push-12 CH-G 1095132 Uponor SPI Fluvia T pump Grundfos Push-12

3.3 Diagrams

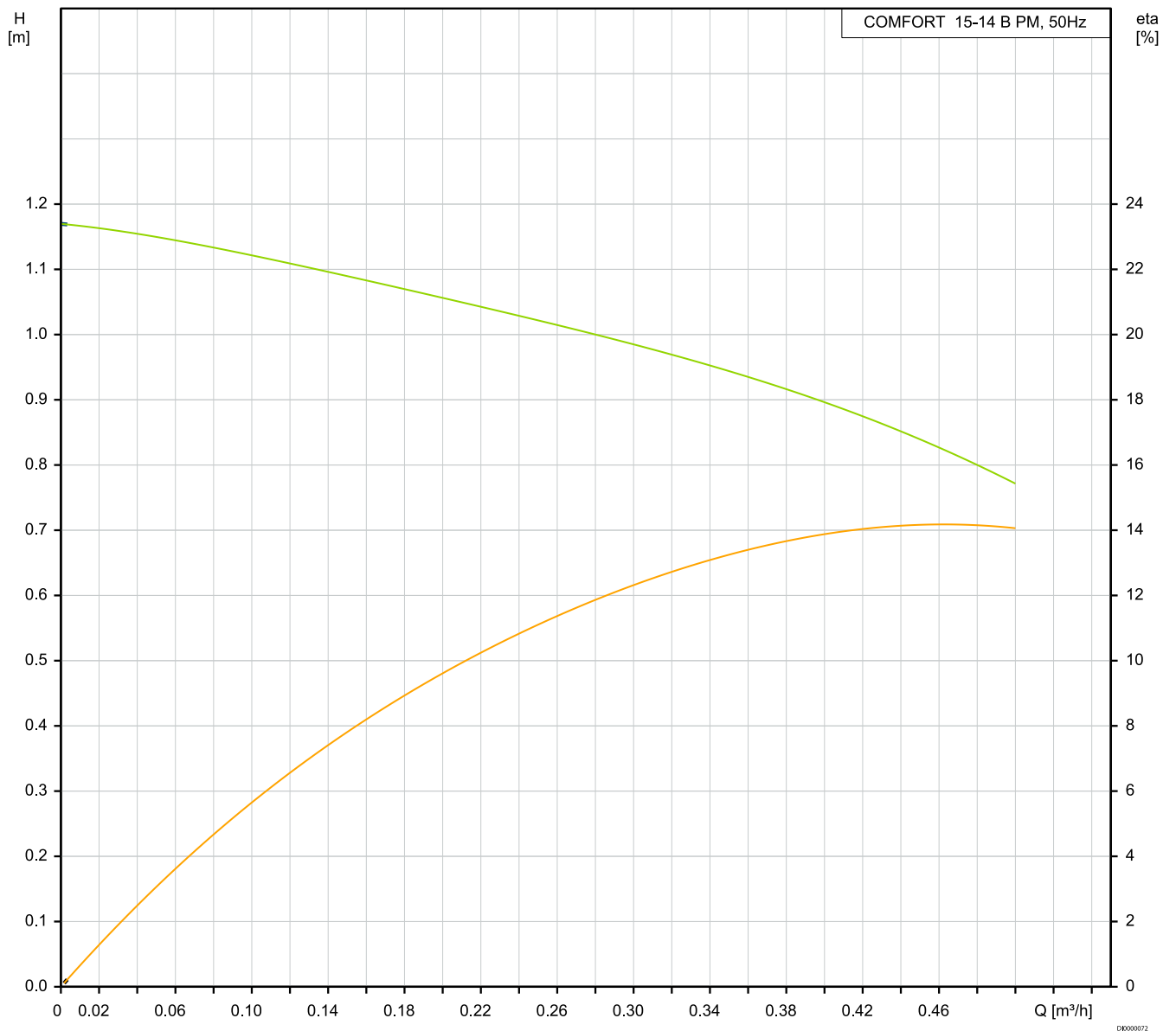

Pump curve for Uponor Fluvia T pumpgroup Push-12

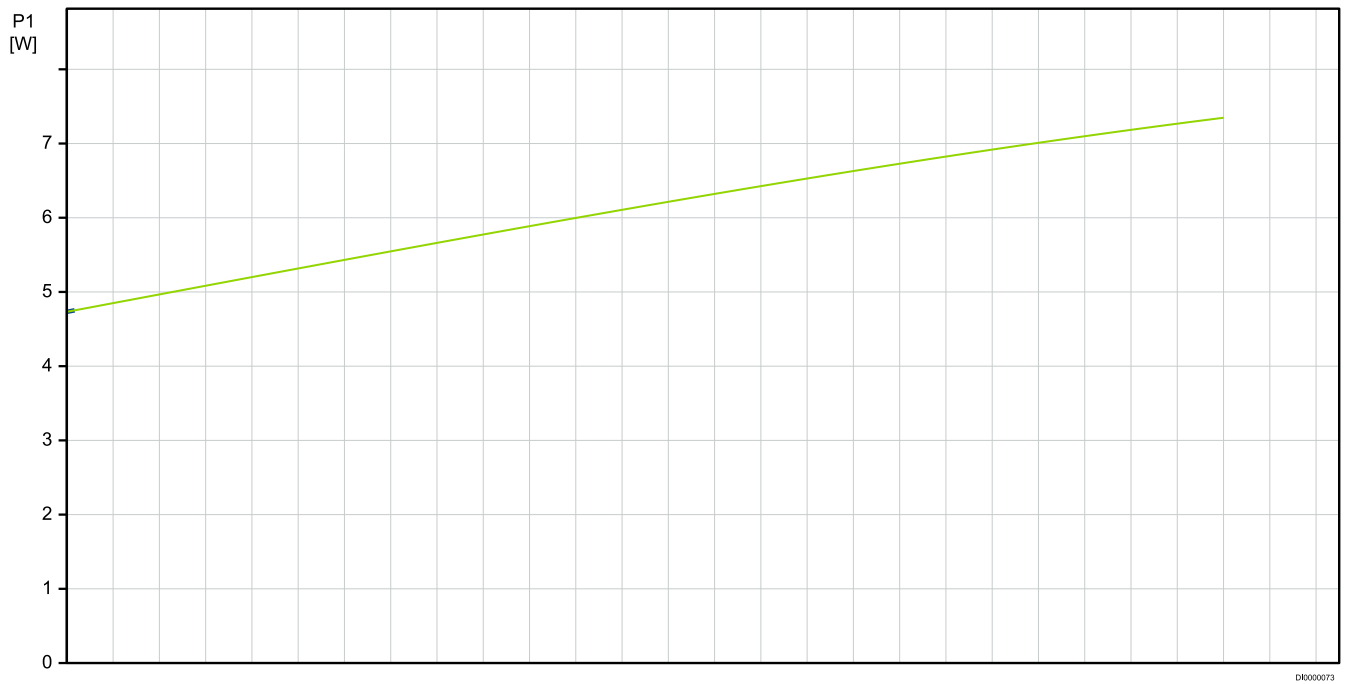

D8000073

Differential pressure at the valve

Thermostat valve	0.5	1.0	1.5	2.0	2.5	4.0	Fully open
Kv value	0.14	0.27	0.38	0.46	0.54	0.65	0.66

Uponor

Uponor GmbH

Industriestraße 56,
D-97437 Hassfurt, Germany

1095145 09-2019_EN
Production: Uponor/ELO

Uponor reserves the right to make changes, without prior notification,
to the specification of incorporated components in line with its policy of
continuous improvement and development.



www.uponor.com