

# Uponor

Uponor Q&E Ø 9.9-32 mm

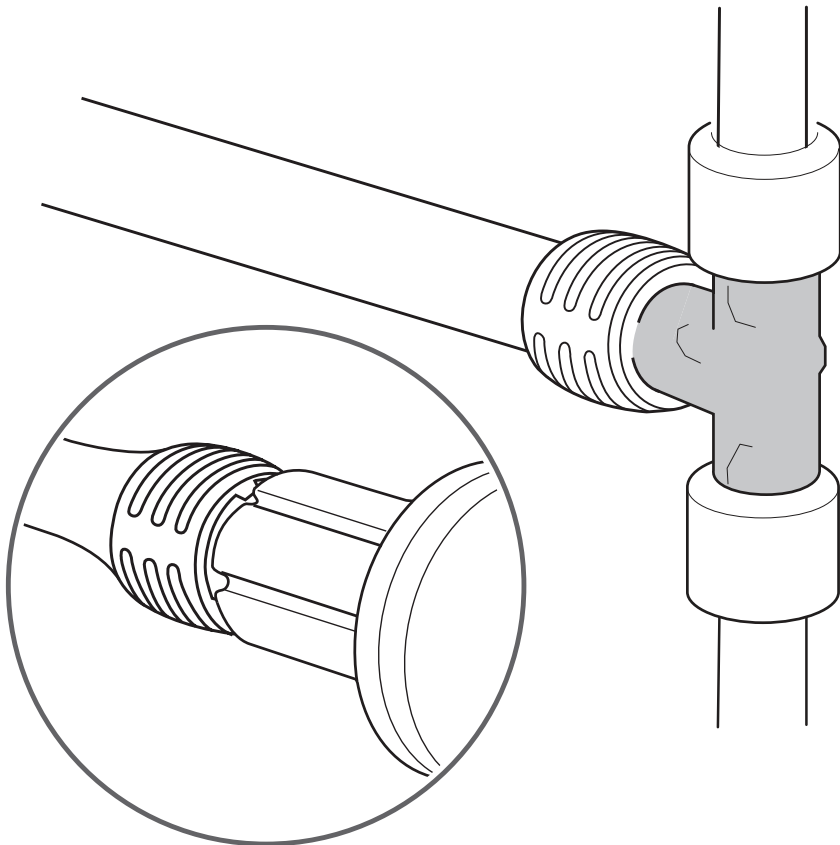

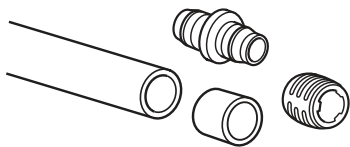

Uponor Aqua Pipe  
Uponor Combi Pipe  
Uponor Comfort Pipe  
Uponor Comfort Pipe PLUS  
Uponor Radi Pipe

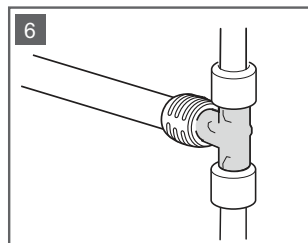
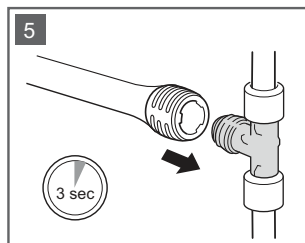
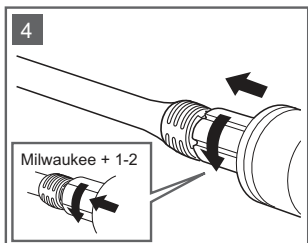
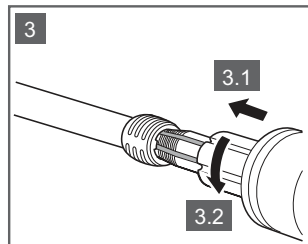
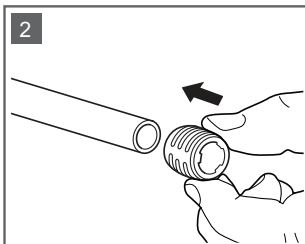
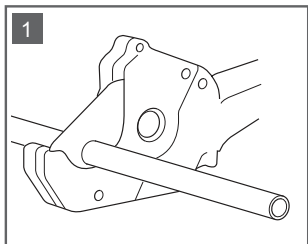

**!**

... DEC JAN FEB ...

< 5 °C

≤ 50 °C

**OK?**

≤ 15 sec

**OPTION**

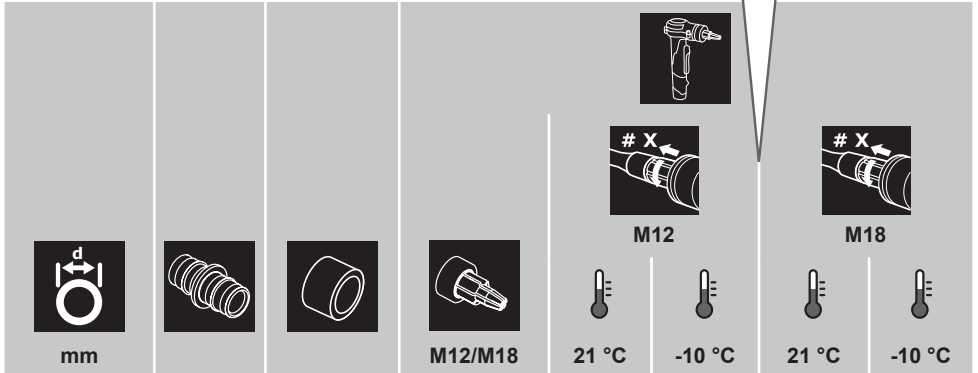
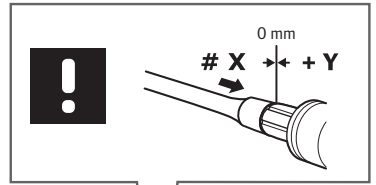



6 bar							
9.9x1.1	9.9	Q&E 9.9	9.9x1.1	6	6	6	5
12x1.1	12	Q&E 12x1.1	12x1.7/1.8/2.0	7	5	9	8
14x2.0	14/15x2.5	Q&E 14	14/15x2.5	6	6	6	7
16x1.5/16x1.8	16	Q&E 16	16x1.8/2.2	3+1	3+1	4	4
16x2.0	16	Q&E 16	16x1.8/2.2	4+1	4+1	4+1	4+1
17x2.0	17/18x2.5	Q&E 17	17/18x2.5	8	8	8	8
20x1.9/20x2.0	20	Q&E 20	20x1.9/2.0/2.3	5+2	6	6	6
25x2.3	25	Q&E 25	25x2.3	8+2	10	9	9
32x2.9	32	Q&E 32	32x2.9	15	16	14	14

10 bar							
12x1.7	12	Q&E 12x1.1	12x1.7/1.8/2.0	5+1	5+1	4+1	5
12x2.0	12	Q&E 12x1.1	12x1.7/2.0	4+2	5+1	4+1	4+1
16x2.2	16	Q&E 16	16x1.8/2.2	5+2	5+1	5+2	5+1
20x2.8	20	Q&E 20	20x2.8	10	11	10-11	11
25x3.5	25	Q&E 25	25x3.5	17	18	19	19
32x4.4	32	Q&E 32	H32x4.4*	-	-	7+3	8+2

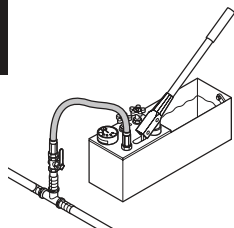
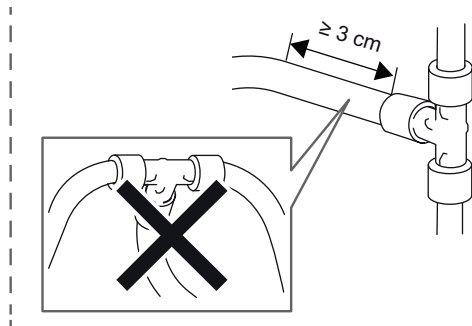
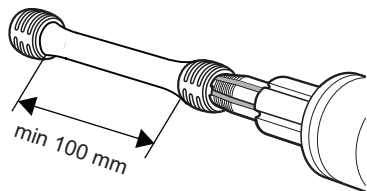
\*) H = only with Milwaukee tool M18



 °C	 h
>+10	0.25
+10 - +5	0.5
+5 - ±0	1.5
±0 - -5	3.0
-5 - -10	4.0

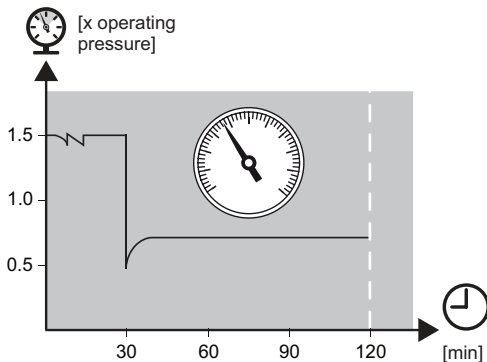

[www.uponor.com/services/download-centre](http://www.uponor.com/services/download-centre)

## Uponor GmbH

Industriestraße 56  
D-97437 Hassfurt, Germany

1087003\_v2\_04/2020\_INT  
Production: Uponor/ELO

Uponor reserves the right to change specifications without prior notice, in keeping with our policy of continuous improvement and development.



[www.uponor.com](http://www.uponor.com)