

Radiant heating & cooling,
plumbing and
local heat distribution

Uponor

Product Catalogue 03-2021

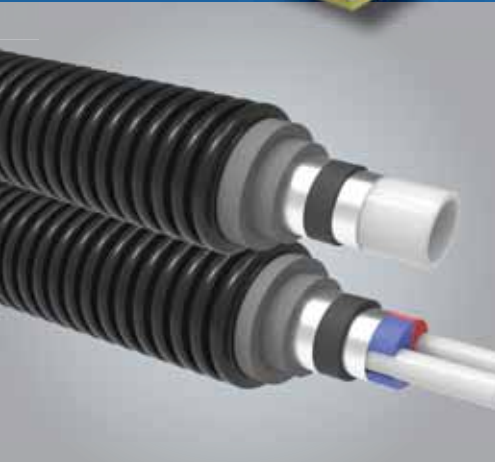
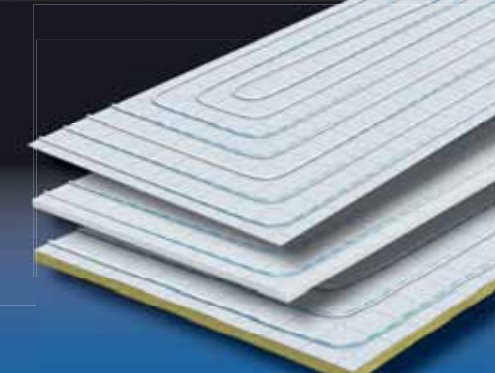

Moving > Forward

Table of contents

Multilayer Pipe Systems

Pipes

Uni Pipe PLUS	Multilayer composite pipe overlapped welded	5
Teck	Conduits for all kinds of Uponor pipes.....	9
Uni	Uponor universal accessories for multilayer composite pipe system	11

Fitting

S-Press PLUS	Press fittings with safety-test feature and colour code	12
RS	Modular fittings for bigger dimensions	38
RTM	Tool-free fitting technology	43
Uni-X	Compression fittings with eurocone for multilayer composite pipe system	45
Uni-C	Compression fittings with Uponor 1/2"	50

Flexible Pipe Systems

Pipes

Aqua Pipe	PE-Xa pipe for tap water installation	54
Radi Pipe	PE-Xa pipe for heating/cooling installation.....	56
Teck	Conduits for all kinds of Uponor pipes.....	58
Flex	Uponor universal accessories for flexible pipe system.....	60

Fitting

Q&E	Q&E fittings for flexible pipes.....	63
Flex-X	Compression fittings with eurocone for flexible pipe system	93
Uni-X	Compression fittings with eurocone for flexible pipe	94
RS	Modular fittings for bigger dimensions	95

Radiant Heating & Cooling

Systems

Minitec	Low height underfloor heating for renovation for pipes Dim 9.9	100
Tecto	UFHC nub panel pipe fixation for pipes Dim 14, 16, 17	106
Nubos	UFHC nub panel pipe fixation for pipes Dim 14 + 16.....	110
Klett	UFHC self-attaching pipe fixation with pipes Dim 14 + 16	113
Tacker	UFHC standard pipe fixation by clip Dim 14, 16, 17, 20.....	117
Fix 14-20	Underfloor heating clamp track for pipes Dim 14, 16, 17, 20.....	122
Classic	Classic steel mesh solution for pipes Dim 16, 17, 20.....	124
Siccus 14	Lightweight dry underfloor heating panels for pipes Dim 14	127
Siccus FX	131
Renovis	Active radiant boards for wall and ceiling with embedded pipes Dim 9.9.....	133
Siccus wall	Dry wall-heating for renovation and extension panels for pipes Dim 14.....	137
Fix 14	Radiant solution for wall and ceiling with clamp track for pipes Dim 14.....	141
Magna	Radiant system for heating and cooling in commercial and industrial areas.....	146
Sport	Radiant system for surface-elastic sprungfloor sports floors.....	152
Meltaway	Outdoors and turf heating areas with pipes PeXb	156
Fix 9,9	Low height wall and ceiling clamp track for pipes Dim 9.9	160
Thermatop M	165

Table of contents

Accessories

Multi	UFHC system accessoires (foils, insulations, edging strips, others)	166
Q&E Supply = 20	IC Q&E PeXa Supply pipes Dim 20.....	170

Distribution

Vario PLUS	UFHC plastic manifolds	171
Vario M	UFHC plastic manifolds	175
Vario S	177
Vario	Cabinets, Valves and accessoires for Vario manifolds.....	180

Supply

Smatrix Move PRO	183
Smatrix Move	Supply controller for radiant heating and cooling.....	187
Fluvia Move/Move PLUS	Pump group with electronic supply water controls	192
Fluvia T	Pump group with thermostatic supply water controls	196

Room temperature control

Smatrix Wave / Style	Wireless room control system for radiant heating and cooling PLUS remote access possibility	199
Smatrix Base PRO / Style	211
Smatrix Base / Style	Wired room control system for radiant heating and cooling	215
Base	230V room control system for radiant heating	228
Smatrix	Room and temperature controls	233

Comfort E

Indoor - Mats Cable Foil Controls

Comfort E	236
-----------	-------	-----

Local Heat Distribution

Ecoflex Thermo	Pre-insulated pipes for distribution of heating and cooling water in buried installations.....	241
Ecoflex Varia	Pre-insulated pipes for distribution of heating and cooling water in buried installations.....	243
Ecoflex Aqua	Pre-insulated pipes for distribution of hot tap water in buried installations.....	245
Ecoflex Quattro	Pre-insulated pipes for distribution of hot tap water and heating water in buried installations	247
Ecoflex Supra	Pre-insulated pipes for distribution of drinking and cooling water in buried installations.....	249
Wipex	Brass fittings for connecting cross-linked polyethylene pipes.....	250
Q&E	LHD pipes and fittings portfolio for Q&E	262
Ecoflex	Accessories for pre-insulated pipe systems	267

Tools

Uncoiling	Uncoilers for Plumbing and Indoor Climate pipes.....	278
Cutting & Preparation	Tools for Plumbing and Indoor Climate pipes	279
Pressing	Tools for Plumbing and Indoor Climate pipes	282
Expanding	Tools for Plumbing and Indoor Climate pipes	287
Fixing	Fixations for Plumbing and Indoor Climate pipes	290
Others	291

Uponor Uni Pipe PLUS



The Uni Pipe PLUS is Uponor's unique multilayer composite pipe for tap water and heating/cooling application. Its bend radius is up to 40 per cent smaller than current multilayer composite pipes: changes of

direction when installing can be achieved by bending the pipe, reducing fitting requirements and installation time.

Your benefits

- Seamless or OWC-technology for highest level of safety
- High dimensional stability, low expansion rates
- Increased flexibility
- 100% oxygen barrier
- Lightweight



Specification

- Oxygen diffusion resistant multi-layer composite pipe (PE-RT - adhesive – seamless aluminium/longitudinally welded aluminium - adhesive - PE-RT) produced using SACP and OWC-technology.
- Fire classification E according to EN 13501-1.
- With pipe end caps as hygienic seal according EN 806.

Application

- Tested/Approved according EN ISO 21003 Multilayer piping systems for hot and cold water installations inside buildings for application class 1,2,4,5/10bar
- Tap water: The permanent operating temperature ranges from 0°C to 70°C at a maximum permanent operating pressure of 10 bar. The short-term malfunction temperature is 95°C for a period of 100 hours in the operating life time.
- Heating: The permanent operating temperature ranges up to 80°C at a maximum permanent operating pressure of 10 bar. The short-term malfunction temperature is 100°C for a period of 100 hours in the operating life time.

Certification

- Approvals by local OM.

Uponor Uni Pipe PLUS white S

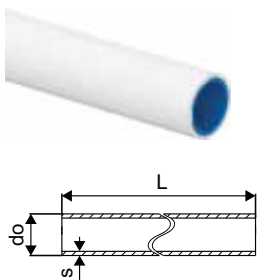

Item no.	Dimension	L	do	s	Qty 2	Qty 1	UOM
		m	mm	mm			
1059572	16x2,0 5m	5	16	2,00	125	5	m
1059573	20x2,25 5m	5	20	2,25	85	5	m
1059574	25x2,5 5m	5	25	2,5	50	5	m
1059575	32x3,0 5m	5	32	3,0	35	5	m

Uponor MLC pipe white S

- bar

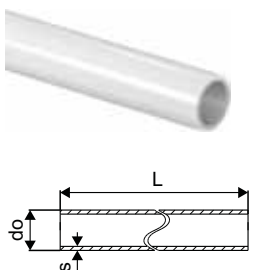

Item no.	Dimension	L	do	s	Qty 2	Qty 1	UOM
		m	mm	mm			
1013446	40x4,0 5m	5	40	4,00	20	5	m
1013449	50x4,5 5m	5	50	4,50	20	5	m
1013451	63x6,0 5m	5	63	6,00	15	5	m
1013453	75x7,5 5m	5	75	7,5	255	5	m
1013455	90x8,5 5m	5	90	8,50	255	5	m
1013457	110x10,0 5m	5	110	10,00	165	5	m

Uponor Uni Pipe PLUS

Uponor Uni Pipe PLUS white

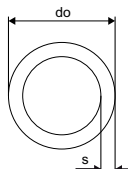

Item no.	Dimension	L m	do mm	s mm	Qty 2	Qty 1	UOM
1059576	16x2,0 100m	100	16	2,0	2000	100	m
1059578	16x2,0 500m	500	16	2,00	3500	500	m

Uponor MLC pipe white

- coil

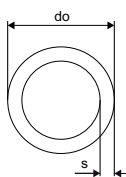

Item no.	Dimension	L m	do mm	s mm	Qty 2	Qty 1	UOM
1013366	14x2,0 200m	200	14	2	2600	200	m

Uponor Uni Pipe PLUS white IPPC

- coil on IPPC palette

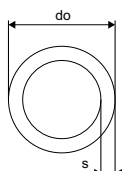

Item no.	Dimension	L m	do mm	s mm	Qty 2	Qty 1	UOM
1084909	16x2,0 200m	200	16	2,0	2600	200	m
1084910	20x2,25 100m	100	20	2,25	1300	100	m
1084911	25x2,5 50m	50	25	2,5	700	50	m
1084912	32x3,0 50m	50	32	3,0	400	50	m

Uponor Uni Pipe PLUS insulated

Specification

- Consists of pipe and insulating layer.
- Supplied in coils.
- pipe insulation made of polyethylene foam with closed-cell material structure.
- With sturdy, seamless foil coating

Uponor Uni Pipe PLUS

Uponor MLC insulated

Specification

- Consists of pipe and insulating layer.
- Supplied in coils.
- Round extruded pipe insulation made of polyethylene foam with closed-cell material structure.
- With sturdy, seamless foil coating

Uponor Uni Pipe PLUS white insulated S4 WLS 040

- Insulation thickness 4 mm
- thermal conductivity $\lambda=0,040$ W/m*k
- round extruded

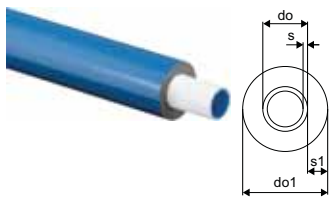

Item no.	Dimension	L m	do mm	do1 mm	s mm	s1 mm	colour	Qty 2	Qty 1	UOM
1063553	16x2,0 blue	100m	100	16	24	2,00	4,0 blue	800	100	m
1063555	20x2,25 blue	100m	100	20	28	2,25	4,0 blue	800	100	m
1063946	25x2,5 blue	50m	50	25	33	2,50	4,0 blue	400	50	m
1091716	32x3,0 blue	50m	50	32	40	3	4 blue	350	50	m

Uponor Uni Pipe PLUS white insulated S6 WLS 035

- Insulation thickness 6 mm
- thermal conductivity $\lambda=0,035$ W/m*k
- round extruded

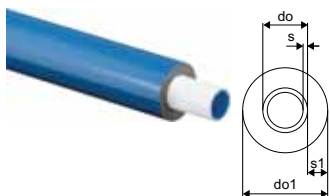

Item no.	Dimension	L m	do mm	do1 mm	s mm	s1 mm	colour	Qty 2	Qty 1	UOM
1063556	16x2,0 blue	75m	75	16	28	2	6 blue	600	75	m
1063557	20x2,25 blue	75m	75	20	32	2,25	6 blue	600	75	m
1063558	25x2,5 blue	50m	50	25	37	2,5	6 blue	400	50	m

Uponor Uni Pipe PLUS

Uponor Uni Pipe PLUS white insulated S6 WLS 040

- Insulation thickness 6 mm
- thermal conductivity $\lambda=0,040$ W/m*k
- round extruded

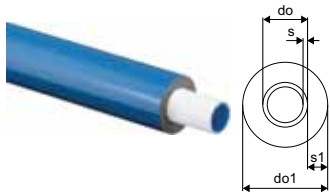

Item no.	Dimension	L m	do mm	do1 mm	s mm	s1 mm	colour	Qty 2	Qty 1	UOM
1091723	16x2,0 blue 75m	75	16	28	2,0	6,0	blue	600	75	m
1091724	20x2,25 blue 75m	75	20	32	2,25	6,0	blue	600	75	m
1091725	25x2,5 blue 50m	50	25	37	2,5	6,0	blue	400	50	m

Uponor Uni Pipe PLUS white insulated S10 WLS 035

- Insulation thickness 10 mm
- thermal conductivity $\lambda=0,035$ W/m*k
- round extruded

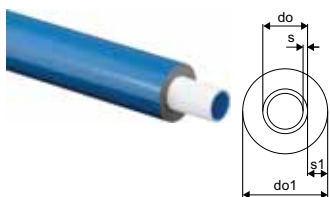

Item no.	Dimension	L m	do mm	do1 mm	s mm	s1 mm	colour	Qty 2	Qty 1	UOM
1062181	16x2,0 blue 75m	75	16	36	2	10	blue	450	75	m
1062182	20x2,25 blue 75m	75	20	40	2,25	10	blue	525	75	m
1062183	25x2,5 blue 50m	50	25	45	2,5	10	blue	350	50	m

Uponor Uni Pipe PLUS in conduit

Specification

- pipe in conduit pipe
- Supplied in coils.
- conduit pipe corrugated made of HDPE

Uponor Uni Pipe PLUS white in conduit

- pipe in conduit

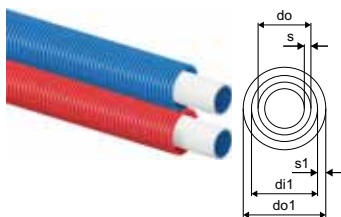

Item no.	Dimension	L m	di1 mm	do mm	do1 mm	s mm	colour	Qty 2	Qty 1	UOM
1063061	16x2,0 - 25/20 red 75m	75	20	16	25	2,0	red	1350	75	m
1063059	16x2,0 - 25/20 blue 75m	75	20	16	25	2,0	blue	1350	75	m
1063062	20x2,25 - 28/23 red 75m	75	23	20	28	2,25	red	900	75	m
1063060	20x2,25 - 28/23 blue 75m	75	23	20	28	2,25	blue	900	75	m

Uponor Teck

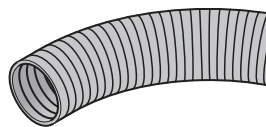

Uponor Teck are conduit pipes designed to protect the interior of flexible multilayer pipes used for tap water and heating/cooling application.

Your benefits

- Ensures safe and secure water supply
- Certified quality
- Protects inner pipe
- Colour coding for hot and cold water



Specification

- Corrugated, made of high density polyethylene (HDPE)
- Fire classification E according to EN 13501-1
- Supplied in coils.

Application

- Used for pipe in pipe (PIP) installations to reduce the risk for water damages and allow for flexible media pipe to be replaced

Uponor Teck conduit

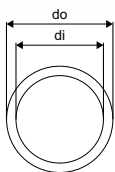

Item no.	Dimension	L m	di mm	do mm	colour	Qty 2	Qty 1	UOM
1012860	25/20 black 50m	50	20	25	black	2500	50	m
1012864	28/23 black 50m	50	23	28	black	2000	50	m
1012869	35/29 black 50m	50	29	35	black	1400	50	m
1012872	43/36 black 25m	25	36	43	black	600	25	m

Uponor Teck conduit

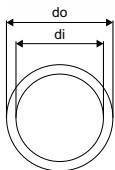

Item no.	Dimension	L m	di mm	do mm	colour	Qty 2	Qty 1	UOM
1012859	25/20 blue 50m	50	20	25	blue	2500	50	m
1012863	28/23 blue 50m	50	23	28	blue	2000	50	m
1012867	35/29 blue 50m	50	29	35	blue	1400	50	m

Uponor Teck conduit

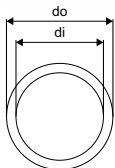

Item no.	Dimension	L m	di mm	do mm	colour	Qty 2	Qty 1	UOM
1012858	25/20 red 50m	50	20	25	red	2500	50	m
1012862	28/23 red 50m	50	23	28	red	2000	50	m
1012866	35/29 red 50m	50	29	35	red	1400	50	m

Uponor Teck

Uponor Teck conduit black

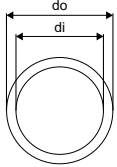

Item no.	Dimension	L m	di mm	do1 mm	colour	Qty 2	Qty 1	UOM
1023127*	54/48 25m	25	48	54	black	600	25	m

Uponor Uni

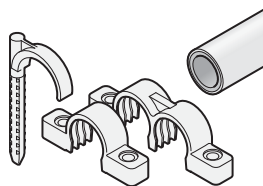

Uponor Uni brings together all accessories needed for installing the multilayer pipe systems.

Your benefits

- Quick installation
- Full range of accessories
- Easy to use



Uponor Teck single plugged hook

- for fixing pipes up to a max. outside diameter of 32 mm to the raw concrete ceiling
- Made of plastic
- Colour: blue
- Drill hole 8 mm

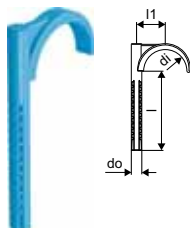

Item no.	Dimension	l mm	l1 mm	di mm	do mm	Qty 2	Qty 1	UOM
1013137	32 60mm	60	20	32	8	1000	50	pce
1013138	32 80mm	80	20	32	8	1000	50	pce

Uponor Teck double plugged hook

- for fixing pipes up to a max. outside diameter of 32 mm to the raw concrete ceiling
- Made of plastic
- Colour: blue
- Drill hole 8 mm

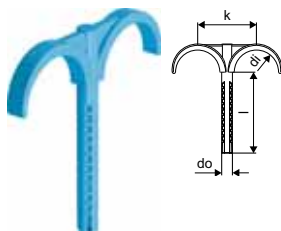

Item no.	Dimension	l mm	di mm	do mm	k mm	Qty 2	Qty 1	UOM
1013139	32 60mm	60	32	8	40	1000	50	pce
1013140	32 80mm	80	32	8	40	1000	50	pce

Uponor MLC pipe clip white

- Easy opening with screwdriver
- Connectable up to 25 mm.

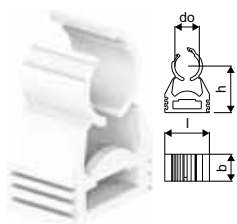

Item no.	Dimension	Qty 2	Qty 1	UOM
1013142	16	20400	100	pce
1013144	20	10200	50	pce
1013145	25	10200	50	pce
1013146	32	500	50	pce
1013147	40	500	25	pce

Uponor S-Press PLUS

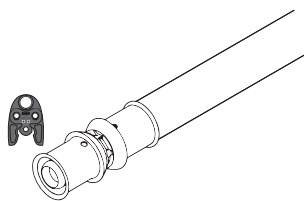

S-Press PLUS/ S-Press, our new generation of press fittings, is the perfect solution for ensuring permanently tight pipe connections. It's 100% backward compatible with current Uponor composite pipes and tools.

Available in dimensions from 14 to 75 mm in both metal and plastic, S-Press PLUS/ S-Press are the fittings that knows no compromise.

Your benefits

- **TOUGH:** Withstand harshest conditions
- **SAFE:** Ensuring your perfect pressing result
- **EASY:** Simplifying planning and installation
- **SMART:** Answering all your questions on site



Specification

- Fixed press sleeve with inspection window
- Precise jaw fixation
- Fast diameter recognition
- Accurate test safety function
- 100% backward compatible with existing Uponor components
- Flow rate optimized fitting body

Application

- Tap water: The permanent operating temperature ranges from 0°C to 70°C at a maximum permanent operating pressure of 10 bar. The short-term malfunction temperature is 95°C for a period of 100 hours in the operating life time.
- Heating: The permanent operating temperature ranges up to 80°C at a maximum permanent operating pressure of 10 bar. The short-term malfunction temperature is 100°C for a period of 100 hours in the operating life time.

if not different mentioned:

- Male and female threads acc.to EN 10226-1.

Certification

- Approvals by local OM.

Uponor S-Press PLUS/ S-Press made of PPSU

Specification

- made of PPSU

Uponor S-Press PLUS

Uponor S-Press PLUS elbow PPSU

- Unique press indicator
- Fast 3-step installation (press without bevel)
- Innovative QR code for immediate digital access
- Colour code



Item no.	Dimension	l1 mm	l2 mm	z1 mm	z2 mm	Qty 2	Qty 1	UOM
1039929	16-16	33	33	13	13	80	20	pce
1039930	20-20	37	37	16	16	80	10	pce
1039931	25-25	48	48	19	19	80	10	pce
1039932	32-32	51	51	23	23	20	5	pce

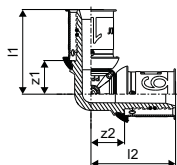

Uponor S-Press composite elbow PPSU

- Fast installation with easy bevel and without calibration
- Colour code



Item no.	Dimension	l1 mm	l2 mm	z1 mm	z2 mm	Qty 2	Qty 1	UOM
1046386	40-40	68	68	29	29	960	5	pce
1046387	50-50	73	73	34	34	576	3	pce
1032877	63-63	101	101	40	40	210	1	pce
1032878	75-75	108	108	47	47	210	1	pce

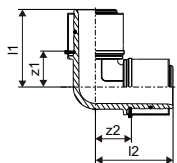

Uponor S-Press composite elbow 45° PPSU

- Fast installation with easy bevel and without calibration
- Colour code



Item no.	Dimension	l1 mm	l2 mm	z1 mm	z2 mm	Qty 2	Qty 1	UOM
1046388	40-40	56	56	17	17	960	5	pce
1046389	50-50	59	59	20	20	576	3	pce
1032879	63-63	83	83	23	23	192	1	pce
1032880	75-75	86	86	25	25	192	1	pce

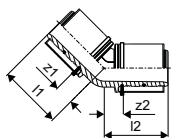

Uponor S-Press PLUS

Uponor S-Press PLUS coupling PPSU

- Unique press indicator
- Fast 3-step installation (press without bevel)
- Innovative QR code for immediate digital access
- Colour code

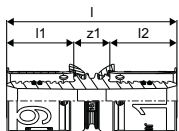

Item no.	Dimension	l mm	l1 mm	l2 mm	z1 mm	Qty 2	Qty 1	UOM
1039933	16-16	51	20	20	11	80	20	pce
1039934	20-20	54	21	21	11	80	10	pce
1039935	25-25	68	28	28	11	80	10	pce
1039936	32-32	69	28	28	13	80	10	pce

Uponor S-Press composite coupling PPSU

- Fast installation with easy bevel and without calibration
- Colour code

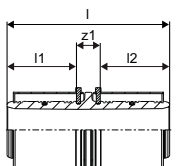

Item no.	Dimension	l mm	l1 mm	l2 mm	z1 mm	Qty 2	Qty 1	UOM
1046401	40-40	91	39	39	13	960	5	pce
1046402	50-50	91	39	39	13	576	3	pce
1032881	63-63	137	61	61	15	384	1	pce
1032882	75-75	137	61	61	15	384	1	pce

Uponor S-Press PLUS reducer PPSU

- Unique press indicator
- Fast 3-step installation (press without bevel)
- Innovative QR code for immediate digital access
- Colour code

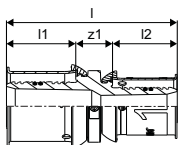

Item no.	Dimension	l mm	l1 mm	l2 mm	z1 mm	Qty 2	Qty 1	UOM
1039937	20-16	53	21	20	11	80	20	pce
1039938	25-16	60	28	20	11	80	10	pce
1039939	25-20	61	28	21	11	80	10	pce
1039940	32-25	69	28	28	13	80	10	pce

Uponor S-Press PLUS

Uponor S-Press reducer PPSU

- Fast installation with easy bevel and without calibration
- Colour code

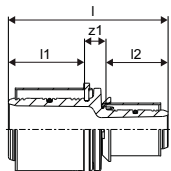

Item no.	Dimension	l mm	l1 mm	l2 mm	z1 mm	Qty 2	Qty 1	UOM
1039941	40-25	80	39	28	12	960	5	pce
1039942	40-32	80	39	28	13	960	5	pce
1039943	50-32	80	39	28	13	1152	3	pce
1046406	50-40	91	39	39	13	576	3	pce
1032883	63-40	115	61	37	17	384	1	pce
1032884	63-50	115	61	37	17	384	1	pce
1032885	75-50	115	61	37	17	384	1	pce
1032886	75-63	137	61	59	17	384	1	pce

Uponor S-Press PLUS tee PPSU

- Unique press indicator
- Fast 3-step installation (press without bevel)
- Innovative QR code for immediate digital access
- Colour code

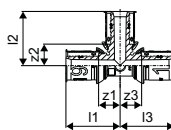

Item no.	Dimension	l1 mm	l2 mm	l3 mm	z1 mm	z2 mm	z3 mm	Qty 2	Qty 1	UOM
1039944	16-16-16	33	33	33	13	13	13	80	10	pce
1039945	20-20-20	37	37	37	16	16	16	80	10	pce
1039946	25-25-25	48	48	48	19	19	19	20	5	pce
1039947	32-32-32	51	51	51	23	23	23	20	5	pce

Uponor S-Press composite tee PPSU

- Fast installation with easy bevel and without calibration
- Colour code

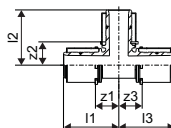

Item no.	Dimension	l1 mm	l2 mm	l3 mm	z1 mm	z2 mm	z3 mm	Qty 2	Qty 1	UOM
1046390	40-40-40	68	68	68	29	29	29	720	5	pce
1046391	50-50-50	73	73	73	33	33	33	288	3	pce
1032887	63-63-63	101	101	101	42	40	42	150	1	pce
1032888	75-75-75	108	107	108	47	47	47	150	1	pce

Uponor S-Press PLUS

Uponor S-Press PLUS tee red. PPSU

- Fixed stainless steel sleeve
- Unique press indicator
- Fast 3-step installation (press without bevel)
- Innovative QR code for immediate digital access
- Colour code

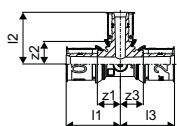

Item no.	Dimension	l1 mm	l2 mm	l3 mm	z1 mm	z2 mm	z3 mm	Qty 2	Qty 1	UOM
1039948	16-20-16	35	35	35	15	13	15	80	10	pce
1039949	20-16-16	37	36	36	16	16	16	80	10	pce
1039950	20-16-20	37	36	37	16	16	16	80	10	pce
1039951	20-20-16	37	37	36	16	16	16	80	10	pce
1039952	20-25-20	41	48	41	19	19	19	80	10	pce
1039953	25-16-16	48	39	39	19	19	19	80	10	pce
1039954	25-16-20	48	39	41	19	19	19	80	10	pce
1039955	25-16-25	48	39	48	19	19	19	80	10	pce
1039956	25-20-20	48	41	41	19	19	19	80	10	pce
1039957	25-20-25	48	41	48	19	19	19	80	10	pce
1039958	32-16-32	51	43	51	23	23	23	20	5	pce
1039959	32-20-32	51	44	51	23	23	23	20	5	pce
1039960	32-25-25	51	51	51	23	23	23	20	5	pce
1039961	32-25-32	51	51	51	23	23	23	20	5	pce

Uponor S-Press tee red. PPSU

- Fast installation with easy bevel and without calibration
- Colour code

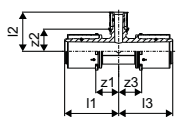

Item no.	Dimension	l1 mm	l2 mm	l3 mm	z1 mm	z2 mm	z3 mm	Qty 2	Qty 1	UOM
1039962	40-20-40	68	49	68	29	28	29	960	5	pce
1039963	40-25-32	68	56	56	29	28	28	960	5	pce
1039964	40-25-40	68	56	68	29	28	29	720	5	pce
1039965	40-32-32	68	56	56	29	28	28	960	5	pce
1039966	40-32-40	68	56	68	29	28	29	720	5	pce
1039967	50-25-40	73	61	73	34	33	34	432	3	pce
1039968	50-25-50	73	61	73	34	33	34	432	3	pce
1039969	50-32-50	73	61	73	34	33	34	432	3	pce

Uponor S-Press composite tee reducer PPSU

- Fast installation with easy bevel and without calibration
- Colour code

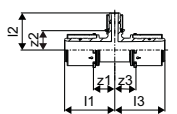

Item no.	Dimension	l1 mm	l2 mm	l3 mm	z1 mm	z2 mm	z3 mm	Qty 2	Qty 1	UOM
1046400	50-40-50	73	73	73	33	33	33	288	3	pce
1032889	63-25-63	101	68	101	40	39	40	150	1	pce
1032890	63-32-63	101	68	101	40	39	40	150	1	pce
1032891	63-40-63	101	79	101	40	40	40	150	1	pce
1032892	75-32-75	108	74	108	47	45	47	150	1	pce
1032893	75-40-75	108	86	108	47	44	47	150	1	pce
1032894	75-50-75	108	86	108	47	49	47	150	1	pce

Uponor S-Press PLUS

Uponor S-Press 14 mm

Specification

- made of tin-plated brass
- Contoured Aluminium-sleeve
- Fast 3-step installation (press without bevel)
- Colour code

Uponor S-Press coupling

Made of tin-plated brass

Contoured Aluminium-sleeve

Fast 3-step installation (press without bevel)

Colour code

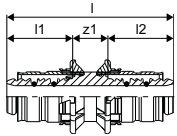

Item no.	Dimension	l	l1	l2	z1	Qty 2	Qty 1	UOM
1015154	14-14	54	21	21	11	80	10	pce

Uponor S-Press PLUS

Uponor S-Press PLUS

Specification

- made of tin-plated DR brass

Uponor S-Press PLUS adapter male thread

- Unique press indicator
- Fast 3-step installation (press without bevel)
- Innovative QR code for immediate digital access

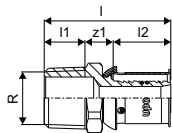

Item no.	Dimension	l mm	l1 mm	l2 mm	R inch	z1 mm	Qty 2	Qty 1	UOM
1070502	16-R1/2"MT	44	14	20	1/2	10	80	20	pce
1070503	16-R3/4"MT	46	16	20	3/4	11	120	15	pce
1070504	20-R1/2"MT	45	14	21	1/2	10	80	20	pce
1070505	20-R3/4"MT	48	15	21	3/4	11	80	10	pce
1070506	20-R1"MT	54	17	21	1	16	80	10	pce
1070507	25-R3/4"MT	55	15	28	3/4	11	80	10	pce
1070508	25-R1"MT	62	18	28	1	16	40	5	pce
1070509	32-R1"MT	62	17	28	1	16	40	5	pce
1070510	32-R1 1/4"MT	66	19	28	1 1/4	19	20	5	pce

Uponor S-Press adapter male thread

- Made of tin-plated brass
- Fast installation with easy bevel and without calibration
- Colour code

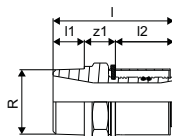

Item no.	Dimension	l mm	l1 mm	l2 mm	R inch	z1 mm	d mm	Qty 2	Qty 1	UOM
1046901	40-R1 1/4"MT	78	20	38	1 1/4	20		960	5	pce
1046902	40-R1 1/2"MT	80	20	38	1 1/2	22	40	960	5	pce
1046905	50-R1 1/2"MT	80	20	38	1 1/2	22	50	1152	3	pce
1046906	50-R2"MT	84	24	38	2	22	50	576	3	pce
1032895	63-R2"MT	111	28	61	2	22		336	1	pce
1032896	75-R2 1/2"MT	110	27	61	2 1/2	22		336	1	pce

Uponor S-Press PLUS adapt. female thread

- Unique press indicator
- Fast 3-step installation (press without bevel)
- Innovative QR code for immediate digital access

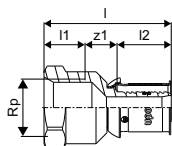

Item no.	Dimension	l mm	l1 mm	l2 mm	Rp inch	z1 mm	Qty 2	Qty 1	UOM
1070515	16-Rp1/2"FT	47	15	20	1/2	12	80	20	pce
1070516	20-Rp1/2"FT	47	15	21	1/2	10	120	15	pce
1070517	20-Rp3/4"FT	51	16	21	3/4	14	80	10	pce
1070518	20-Rp1"FT	52	19	21	1	12	80	20	pce
1070519	25-Rp3/4"FT	56	17	28	3/4	11	40	5	pce
1070520	25-Rp1"FT	59	19	28	1	12	40	5	pce
1070521	32-Rp1"FT	58	20	28	1	10	40	5	pce
1070522	32-Rp1 1/4"FT	62	21	28	1 1/4	13	20	5	pce

Uponor S-Press PLUS

Uponor S-Press adapter female thread

- Made of tin-plated brass
- Fast installation with easy bevel and without calibration
- Colour code

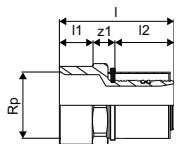

Item no.	Dimension	l	l1	l2	Rp	z1	Qty 2	Qty 1	UOM
		mm	mm	mm	inch	mm			
1046903	40-Rp1 1/4"FT	73	21	38	1 1/4	14	960	5	pce
1046904	40-Rp1 1/2"FT	77	21	38	1 1/2	18	960	5	pce
1046907	50-Rp1 1/2"FT	73	21	38	1 1/2	14	1152	3	pce

Uponor S-Press PLUS elbow

- Unique press indicator
- Fast 3-step installation (press without bevel)
- Innovative QR code for immediate digital access

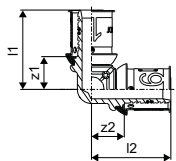

Item no.	Dimension	l1	l2	z1	z2	Qty 2	Qty 1	UOM
		mm	mm	mm	mm			
1070523	16-16	34	34	14	14	80	20	pce
1070524	20-20	37	37	16	16	80	10	pce
1070525	25-25	47	47	19	19	40	5	pce
1070526	32-32	51	51	23	23	20	5	pce

Uponor S-Press elbow

- Made of tin-plated brass
- Fast installation with easy bevel and without calibration
- Colour code

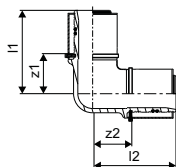

Item no.	Dimension	l1	l2	z1	z2	Qty 2	Qty 1	UOM
		mm	mm	mm	mm			
1046908	40-40	72	72	34	34	600	5	pce
1046911	50-50	79	79	41	41	240	3	pce

Uponor S-Press PLUS

Uponor S-Press PLUS bend

- Made of casted DR brass
- Unique press indicator
- Fast 3-step installation (press without bevel)
- Innovative QR code for immediate digital access
- extra low pressure loss

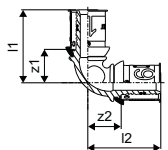

Item no.	Dimension	l1 mm	l2 mm	z1 mm	z2 mm	Qty 2	Qty 1	UOM
1070527	16-16	37	37	17	17	80	10	pce
1070528	20-20	40	40	19	19	80	10	pce
1070529	25-25	50	50	22	22	40	5	pce
1070530	32-32	56	56	28	28	20	5	pce

Uponor S-Press PLUS elbow male thread

- Unique press indicator
- Fast 3-step installation (press without bevel)
- Innovative QR code for immediate digital access

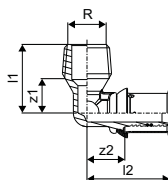

Item no.	Dimension	l1 mm	l2 mm	R inch	z1 mm	z2 mm	Qty 2	Qty 1	UOM
1070532	16-R1/2"MT	30	37	1/2	15	17	80	20	pce
1070533	20-R1/2"MT	32	41	1/2	15	19	80	10	pce
1070534	20-R3/4"MT	34	41	3/4	18	19	80	10	pce
1070535	25-R3/4"MT	36	48	3/4	20	19	40	5	pce
1070536	25-R1"MT	43	51	1	22	23	40	5	pce
1070537	32-R1"MT	43	51	1	22	23	20	5	pce

Uponor S-Press elbow adapter male thread

- Made of tin-plated brass
- Fast installation with easy bevel and without calibration
- Colour code

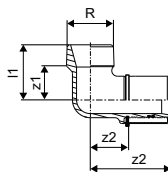

Item no.	Dimension	l1 mm	l2 mm	R inch	z1 mm	z2 mm	Qty 2	Qty 1	UOM
1046909	40-R1 1/4"MT	49	72	1 1/4	30	34	500	5	pce

Uponor S-Press PLUS

Uponor S-Press PLUS elbow female thread

- Unique press indicator
- Fast 3-step installation (press without bevel)
- Innovative QR code for immediate digital access

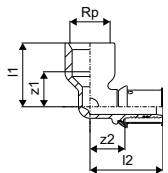

Item no.	Dimension	l1 mm	l2 mm	Rp inch	z1 mm	z2 mm	Qty 2	Qty 1	UOM
1070539	16-Rp1/2"FT	33	38	1/2	18	18	80	10	pce
1070540	20-Rp1/2"FT	36	41	1/2	21	19	80	10	pce
1070541	20-Rp3/4"FT	36	43	3/4	19	22	40	10	pce
1070542	25-Rp3/4"FT	40	50	3/4	23	22	20	5	pce
1070543	25-Rp1"FT	45	54	1	25	26	20	5	pce
1070544	32-Rp1"FT	49	54	1	30	26	20	5	pce

Uponor S-Press elbow adap. female thread

- Made of tin-plated brass
- Fast installation with easy bevel and without calibration
- Colour code

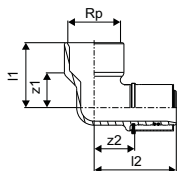

Item no.	Dimension	l1 mm	l2 mm	Rp inch	z1 mm	z2 mm	Qty 2	Qty 1	UOM
1046910	40-Rp1 1/2"FT	59	75	1 1/2	38	37	500	5	pce
1046912	50-Rp1 1/2"FT	59	79	1 1/2	38	41	300	3	pce

Uponor S-Press PLUS elbow 45°

- Unique press indicator
- Fast 3-step installation (press without bevel)
- Innovative QR code for immediate digital access

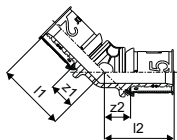

Item no.	Dimension	l1 mm	l2 mm	z1 mm	z2 mm	Qty 2	Qty 1	UOM
1070545	25-25	46	46	18	18	20	5	pce
1070546	32-32	49	49	23	23	20	5	pce

Uponor S-Press PLUS

Uponor S-Press elbow 45°

- Made of tin-plated brass
- Fast installation with easy bevel and without calibration
- Colour code

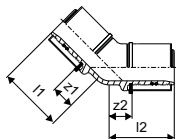

Item no.	Dimension	l1 mm	l2 mm	z1 mm	z2 mm	Qty 2	Qty 1	UOM
1046913	40-40	59	59	21	21	500	5	pce
1046914	50-50	63	63	25	25	300	3	pce

Uponor S-Press PLUS coupling

- Unique press indicator
- Fast 3-step installation (press without bevel)
- Innovative QR code for immediate digital access

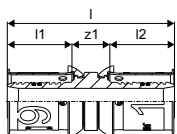

Item no.	Dimension	l mm	l1 mm	l2 mm	z1 mm	Qty 2	Qty 1	UOM
1070547	16-16	51	20	20	12	80	20	pce
1070548	20-20	54	21	21	12	80	10	pce
1070549	25-25	68	28	28	12	80	10	pce
1070550	32-32	68	28	28	12	40	5	pce

Uponor S-Press coupling

- Made of tin-plated brass
- Fast installation with easy bevel and without calibration
- Colour code

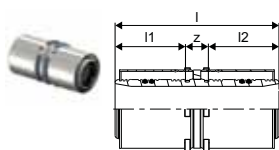

Item no.	Dimension	l mm	l1 mm	l2 mm	z1 mm	Qty 2	Qty 1	UOM
1046932	40-40	88	38	38	12	960	5	pce
1046935	50-50	88	38	38	12	576	3	pce

Uponor S-Press PLUS reducer

- Unique press indicator
- Fast 3-step installation (press without bevel)
- Innovative QR code for immediate digital access

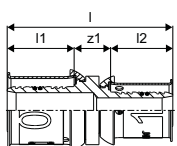

Item no.	Dimension	l mm	l1 mm	l2 mm	z1 mm	Qty 2	Qty 1	UOM
1070552	20-16	53	21	20	12	80	20	pce
1070553	25-16	60	28	20	12	80	10	pce
1070554	25-20	61	28	21	12	80	10	pce
1070555	32-20	61	28	21	12	80	10	pce
1070556	32-25	68	28	28	12	80	10	pce

Uponor S-Press PLUS

Uponor S-Press reducer

- Made of tin-plated brass

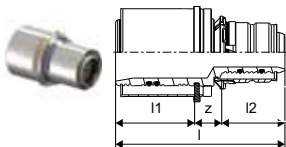

Item no.	Dimension	l	l1	l2	z1	Qty 2	Qty 1	UOM
		mm	mm	mm	mm			
1046930	40-25	81	38	30	13	960	5	pce
1046931	40-32	81	38	30	13	960	5	pce
1046933	50-32	81	38	30	13	1152	3	pce
1046934	50-40	89	38	38	14	576	3	pce

Uponor S-Press PLUS tee

- Unique press indicator
- Fast 3-step installation (press without bevel)
- Innovative QR code for immediate digital access



Item no.	Dimension	l1	l2	l3	z1	z2	z3	Qty 2	Qty 1	UOM
		mm	mm	mm	mm	mm	mm			
1070560	16-16-16	34	34	34	14	14	14	80	10	pce
1070561	20-20-20	37	37	37	16	16	16	80	10	pce
1070562	25-25-25	47	47	47	19	19	19	20	5	pce
1070563	32-32-32	51	51	51	23	23	23	20	5	pce

Uponor S-Press tee

- Made of tin-plated brass
- Fast installation with easy bevel and without calibration
- Colour code



Item no.	Dimension	l1	l2	l3	z1	z2	z3	Qty 2	Qty 1	UOM
		mm	mm	mm	mm	mm	mm			
1046921	40-40-40	72	72	72	34	34	34	400	5	pce
1046928	50-50-50	79	79	79	41	41	41	300	3	pce

Uponor S-Press PLUS

Uponor S-Press PLUS tee reducer

- Unique press indicator
- Fast 3-step installation (press without bevel)
- Innovative QR code for immediate digital access

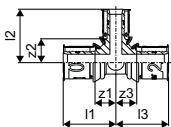

Item no.	Dimension	l1 mm	l2 mm	l3 mm	z1 mm	z2 mm	z3 mm	Qty 2	Qty 1	UOM
1070566	16-20-16	36	37	36	16	16	16	80	10	pce
1070567	20-16-16	35	36	34	14	16	14	40	10	pce
1070568	20-16-20	35	36	35	14	16	14	80	20	pce
1070569	20-20-16	37	37	36	16	16	16	80	20	pce
1070570	20-25-16	40	47	38	19	19	19	40	10	pce
1070571	20-25-20	40	47	40	19	19	19	40	10	pce
1070572	25-16-16	44	38	36	16	19	17	40	5	pce
1070573	25-16-20	44	38	38	16	19	17	40	5	pce
1070574	25-16-25	42	38	42	14	19	14	20	5	pce
1070575	25-20-16	44	40	36	16	19	17	40	5	pce
1070576	25-20-20	44	40	38	16	19	17	40	5	pce
1070577	25-20-25	44	40	44	16	19	16	20	5	pce
1070578	25-25-16	47	47	38	19	19	19	20	5	pce
1070579	25-32-25	50	48	50	22	20	22	20	5	pce
1070580	32-16-32	43	42	43	15	22	15	20	5	pce
1070581	32-20-32	45	43	45	17	22	17	20	5	pce
1070582	32-25-25	48	50	48	20	22	20	20	5	pce
1070583	32-25-32	48	50	48	20	22	20	20	5	pce

Uponor S-Press tee reducer

- Made of tin-plated brass
- Fast installation with easy bevel and without calibration
- Colour code

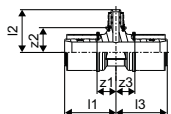

Item no.	Dimension	l1 mm	l2 mm	l3 mm	z1 mm	z2 mm	z3 mm	Qty 2	Qty 1	UOM
1046916	40-20-40	60	50	60	22	28	22	400	5	pce
1046917	40-25-32	61	60	53	23	30	23	500	5	pce
1046918	40-25-40	61	60	61	23	30	23	400	5	pce
1046919	40-32-32	65	60	57	27	30	26	400	5	pce
1046920	40-32-40	65	60	65	27	30	27	400	5	pce
1046924	50-25-40	61	65	61	23	35	23	300	3	pce
1046925	50-25-50	61	65	61	23	35	23	240	3	pce
1046926	50-32-50	65	65	65	27	35	27	300	3	pce
1046927	50-40-50	72	79	72	34	41	34	300	3	pce

Uponor S-Press PLUS

Uponor S-Press PLUS tee male thread

- Unique press indicator
- Fast 3-step installation (press without bevel)
- Innovative QR code for immediate digital access

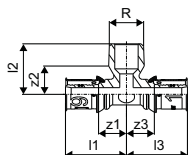

Item no.	Dimension	l1 mm	l2 mm	l3 mm	R inch	z1 mm	z2 mm	z3 mm	Qty 2	Qty 1	UOM
1070592	16-R1/2"MT-16	38	30	38	1/2	18	15	18	40	10	pce
1070593	25-R3/4"MT-25	48	36	48	3/4	19	21	19	20	5	pce
1070594	32-R3/4"MT-32	48	40	48	3/4	19	25	19	20	5	pce

Uponor S-Press PLUS tee female thread

- Unique press indicator
- Fast 3-step installation (press without bevel)
- Innovative QR code for immediate digital access

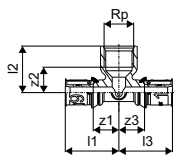

Item no.	Dimension	l1 mm	l2 mm	l3 mm	Rp inch	z1 mm	z2 mm	z3 mm	Qty 2	Qty 1	UOM
1070595	16-Rp1/2"FT-16	38	33	38	1/2	18	18	18	40	10	pce
1070596	20-Rp1/2"FT-20	40	35	40	1/2	19	20	19	60	15	pce
1070597	20-Rp3/4"FT-20	43	37	43	3/4	22	20	22	40	10	pce
1070598	25-Rp1/2"FT-25	48	37	48	1/2	19	22	19	20	5	pce
1070599	25-Rp3/4"FT-25	50	40	50	3/4	22	23	22	20	5	pce
1070600	32-Rp1/2"FT-32	47	40	47	1/2	18	25	18	20	5	pce
1070601	32-Rp3/4"FT-32	51	44	51	3/4	23	27	23	20	5	pce

Uponor S-Press tee adapter female thread

- Made of tin-plated brass
- Fast installation with easy bevel and without calibration
- Colour code

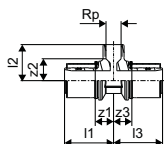

Item no.	Dimension	l1 mm	l2 mm	l3 mm	Rp inch	z1 mm	z2 mm	z3 mm	Qty 2	Qty 1	UOM
1046922	40-Rp1/2"FT-40	69	47	69	1/2	31	30	31	500	5	pce
1046923	40-Rp3/4"FT-40	64	47	64	3/4	26	31	26	400	5	pce
1046929	50-Rp1"FT-50	72	56	72	1	34	37	34	240	3	pce

Uponor S-Press PLUS

Uponor S-Press PLUS adapter swivel nut

- Unique press indicator
- Fast 3-step installation (press without bevel)
- Innovative QR code for immediate digital access
- Releasable screw connector for connection to on-wall fittings, filters and shut-off valves
- Thread acc. to EN ISO 228-1.

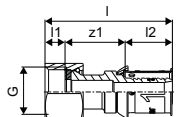

Item no.	Dimension	l	l1	l2	G	z1	Qty 2	Qty 1	UOM
		mm	mm	mm	inch	mm			
1070602	16-G1/2"SN	53	8	20	1/2	25	30	1	pce
1070603	16-G3/4"SN	44	8	20	3/4	17	20	1	pce
1070604	20-G1/2"SN	59	8	21	1/2	30	20	1	pce
1070605	20-G3/4"SN	46	8	21	3/4	17	20	1	pce
1070606	25-G3/4"SN	64	8	28	3/4	28	15	1	pce
1070607	25-G1"SN	57	9	28	1	20	15	1	pce
1070610	32-G1 1/4"SN	59	9	28	1 1/4	22	10	1	pce

Uponor S-Press adapter swivel nut

- Made of tin-plated brass
- Fast installation with easy bevel and without calibration
- Colour code
- Releasable screw connector for connection to on-wall fittings, filters and shut-off valves
- Thread acc. to EN ISO 228-1.

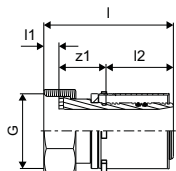

Item no.	Dimension	l	l1	l2	G	z1	Qty 2	Qty 1	UOM
		mm	mm	mm	inch	mm			
1046937	40-G1 1/2"SN	77	10	38	1 1/2	30	960	5	pce
1046938	50-G1 3/4"SN	82	12	38	1 3/4	32	1152	3	pce
1046939	50-G2"SN	82	12	38	2	32	576	3	pce

Uponor S-Press PLUS elbow swivel nut

- Unique press indicator
- Fast 3-step installation (press without bevel)
- Innovative QR code for immediate digital access
- Releasable screw connector for connection to on-wall fittings, filters and shut-off valves
- Thread acc. to EN ISO 228-1.

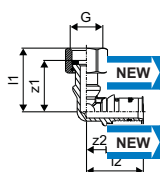

Item no.	Dimension	l1	l2	G	z1	z2	Qty 2	Qty 1	UOM
		mm	mm	inch	mm	mm			
1105818	16-G3/4"SN	45	39	3/4	37	19	10	1	pce
1070613	20-G1/2"SN	46	41	1/2	39	19	20	1	pce
1105819	20-G3/4"SN	45	41	3/4	37	19	10	1	pce

Uponor S-Press PLUS

Uponor S-Press PLUS tap elbow M

- Unique press indicator
- Fast 3-step installation (press without bevel)
- Innovative QR code for immediate digital access
- for on wall installation or attachment with rotation protection to the Uponor Smart Aqua mounting angles and plates.



Item no.	Dimension	l1	l2	l3	Rp	z1	z3	k	Qty 2	Qty 1	UOM
		mm	mm	mm	inch	mm	mm	mm			
1070638	16-Rp3/8"FT	45	20	20	3/8	25	8	40	40	10	pce
1070639	16-Rp1/2"FT	41	20	20	1/2	21	5	40	40	10	pce
1070640	20-Rp1/2"FT	44	20	21	1/2	23	6	40	40	10	pce
1070641	20-Rp3/4"FT	45	20	23	3/4	24	7	40	20	5	pce
1070642	25-Rp3/4"FT	54	27	25	3/4	26	8	40	20	5	pce

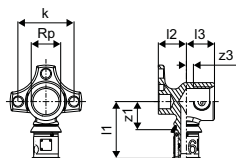

Uponor S-Press PLUS tap elbow L

- Unique press indicator
- Fast 3-step installation (press without bevel)
- Innovative QR code for immediate digital access
- for on wall installation or attachment with rotation protection to the Uponor Smart Aqua mounting angles and plates.



Item no.	Dimension	l1	l2	l3	Rp	z1	z3	k	Qty 2	Qty 1	UOM
		mm	mm	mm	inch	mm	mm	mm			
1070644	16-Rp1/2"FT	42	20	30	1/2	22	15	40	40	10	pce
1070645	20-Rp1/2"FT	46	20	30	1/2	25	15	40	40	10	pce

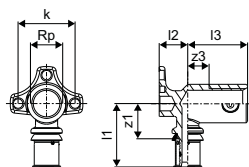

Uponor Smart Aqua set sound protec elbow

- set is suitable for two Uponor Smart Aqua tap elbows 16-Rp1/2"FT or 20-Rp1/2"FT
- Pins and screws M6 x 16 included
- Made of EPDM.
- Sound protection acc. DIN 4109.



12.21

Item no.	l1	l2	z1	Qty 2	Qty 1	UOM
	mm	mm	mm			
1057846*	30	18	6	384	1	set

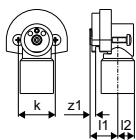

Uponor S-Press PLUS

Uponor S-Press PLUS U-tap elbow

- Unique press indicator
- Fast 3-step installation (press without bevel)
- Innovative QR code for immediate digital access
- For on wall installation or attachment with rotation protection to the Uponor Smart Aqua mounting angles and plates.

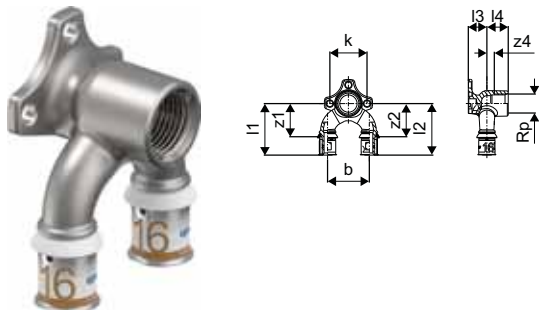

Item no.	Dimension	l1	l2	l3	l4	Rp	z1	z2	z4	b	k	Qty 2	Qty 1	UOM
		mm	mm	mm	mm	inch	mm	mm	mm	mm	mm			
1070629	16-Rp1/2"FT-16	56	56	20	23	1/2	36	36	8	45	40	20	5	pce
1070630	20-Rp1/2"FT-20	57	57	20	23	1/2	36	36	8	45	40	960	5	pce
1070631	20-Rp1/2"FT-16	57	56	20	23	1/2	36	36	8	45	40	960	5	pce
1070632	16-Rp1/2"FT-20	56	57	20	23	1/2	36	36	8	45	40	960	5	pce
1070633	25-Rp1/2"FT-25	64	64	27	24	1/2	36	36	9	60	40	576	3	pce
1070634	25-Rp1/2"FT-20	64	57	27	24	1/2	36	36	9	60	40	576	3	pce
1070635	20-Rp1/2"FT-25	57	64	27	24	1/2	36	36	9	60	40	576	3	pce

Uponor Smart Aqua sound protection U-tap

- for one Uponor Smart Aqua U-tap elbow
- Pin and screws M6 x 16 included
- Made of EPDM
- Sound protection acc. DIN 4109.



12.21

Item no.	l1	l2	z1	k	Qty 2	Qty 1	UOM
	mm	mm	mm	mm			
1060367*	26	21	6	45	8	1	pce

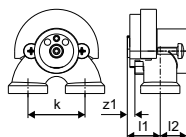

Uponor S-Press PLUS

Uponor S-Press PLUS U-tap elbow mixer

- Fixed stainless steel sleeve
- Unique press indicator
- Fast 3-step installation (press without bevel)
- Innovative QR code for immediate digital access
- for inwall mixer and flushing tank connection in serial and loop installation.



Item no.	Dimension	l1	l2	R	z1	z2	b	Qty 2	Qty 1	UOM
		mm	mm	inch	mm	mm	mm			
1070636	16-16-R1/2"MT	57	60	1/2	42	40	45	960	5	pce
1070637	20-20-R3/4"MT	61	62	3/4	42	40	45	960	5	pce

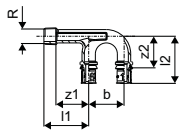

Uponor S-Press PLUS tap elbow twin 90° long

- Unique press indicator
- Fast 3-step installation (press without bevel)
- Innovative QR code for immediate digital access
- For on wall installation or attachment with rotation protection to the Uponor Smart Aqua mounting angles and plates.
- Thread acc. to EN ISO 228-1

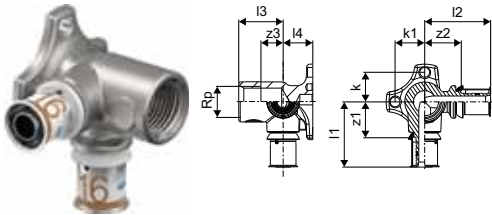

Item no.	Dimension	l1	l2	l3	l4	Rp	z1	z2	z3	k	k1	Qty 2	Qty 1	UOM
		mm	mm	mm	mm	inch	mm	mm	mm	mm	mm			
1070648	16-Rp1/2"FT-16	44	45	30	20	1/2	24	25	15	20	20	40	10	pce
1070649	20-Rp1/2"FT-20	46	46	30	20	1/2	24	25	15	20	20	40	10	pce

Uponor S-Press PLUS elbow adapter UPS

- Unique press indicator
- Fast 3-step installation (press without bevel)
- Innovative QR code for immediate digital access



Item no.	Dimension	l1	l2	Rp	M	z1	z2	Qty 2	Qty 1	UOM
		mm	mm	inch	mm	mm	mm			
1070657	16-Rp1/2"FT	29	48	1/2	35x1.5	8	28	10	1	pce

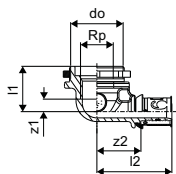

Uponor S-Press PLUS

Uponor Smart Aqua adapter flushing tank Geberit

- Compression adapter, union nut and inner sleeve made of brass
- For connection of Uponor pipes to in wall flushing box Geberit and all MeplaFix R1/2 male threads



Item no.	Dimension	l	l1	l2	G	z1	Qty 2	Qty 1	UOM
		mm	mm	mm	inch	mm			
1058097	16-1/2"FT	22	14	8	1/2	1	25	1	pce

Uponor S-Press PLUS stop end

- Unique press indicator
- Fast 3-step installation (press without bevel)
- Innovative QR code for immediate digital access



Item no.	Dimension	l	l1	l2	Qty 2	Qty 1	UOM
		mm	mm	mm			
1070621	16	27	7	20	160	40	pce
1070622	20	28	7	21	7680	20	pce
1070623	25	35	7	28	3840	10	pce
1070624	32	35	7	28	1920	5	pce

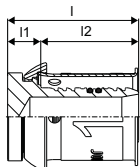

Uponor MLC pressure testing plug

- Re-usable plug for pressure test of installations, screwed into bevelled pipe
- After completion of the pressure test unscrew the pressure test plug out of the pipe and cut it to the required length (length of plug + 1.5mm).



Item no.	Dimension	l	l1	l2	G	z1	Qty 2	Qty 1	UOM
		mm	mm	mm	inch	mm			
1013756	16	52	14	30	1/2	8	7680	20	pce
1013760	20	52	14	30	1/2	8	3840	20	pce
1013762	25	57	14	35	1/2	8	3840	10	pce
1013764	32	64	14	42	1/2	8	3840	10	pce
1013765	40	67	14	45	1/2	8	960	5	pce

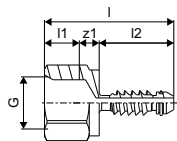

Uponor S-Press PLUS

Uponor S-Press valve U-shaped

- Made of brass
- Contoured Aluminium-sleeve
- Fast 3-step installation (press without bevel)
- Colour code
- For cold and hot tap water application

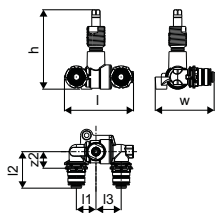

Item no.	Dimension	l mm	I1 mm	I2 mm	I3 mm	z2 mm	h mm	w mm	Qty 2	Qty 1	UOM
1089028	16	74	21	39	27	18	85	63	10	1	pce
1089027	20	76	21	40	27	18	86	63	10	1	pce
1089026	25	106	36	50	36	20	92	74	5	1	pce

Uponor S-Press valve straight

- Made of brass
- Contoured Aluminium-sleeve
- Fast 3-step installation (press without bevel)
- Colour code
- For cold and hot tap water application

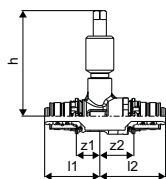

Item no.	Dimension	I1 mm	I2 mm	z1 mm	z2 mm	h mm	Qty 2	Qty 1	UOM
1089031	16	37	44	16	23	71	10	1	pce
1089030	20	38	45	16	23	71	10	1	pce
1089029	25	48	54	18	24	73	10	1	pce

Uponor S-Press PLUS adapter wall penetr.

- Unique press indicator
- Fast 3-step installation (press without bevel)
- Innovative QR code for immediate digital access
- For lead-through through walls.
- Dimensions of attachment plate (H x W x D) 100 x 50 x 2 mm.
- Hole circle diameter 33 mm.

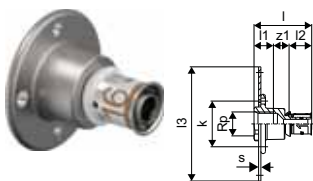

Item no.	Dimension	l mm	I1 mm	I2 mm	I3 mm	s mm	Rp inch	z1 mm	k mm	Qty 2	Qty 1	UOM
1070652	16-G1/2"FT	51	17	20	100	2	1/2	14	40	5	1	pce

Uponor S-Press PLUS

Uponor S-Press PLUS tap elbow LWC

- Unique press indicator
- Fast 3-step installation (press without bevel)
- Innovative QR code for immediate digital access
- Incl. twist-proof attachment and sound protection
- For lead-through through walls.

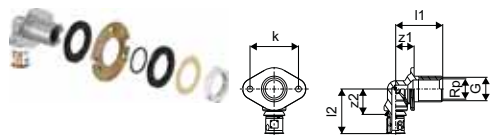

Item no.	Dimension	l1	l2	G	Rp	z1	z2	g	k	Qty 2	Qty 1	UOM
		mm	mm	inch	inch	mm	mm	mm	mm			
1070653	16-Rp1/2"FT l=25	49	46	3/4	1/2	19	26	NaN	50	5	1	pce
1070654	16-Rp1/2"FT l=35	59	46	3/4	1/2	19	26	NaN	50	5	1	pce

Uponor S-Press PLUS U-tap elbow LWC

- Unique press indicator
- Fast 3-step installation (press without bevel)
- Innovative QR code for immediate digital access
- Incl. twist-proof attachment and sound protection
- For lead-through through walls.

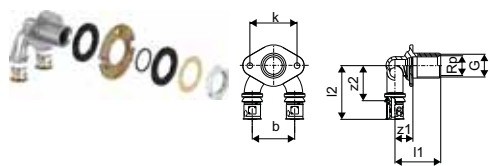

Item no.	Dimension	l1	l2	G	Rp	z1	z2	b	k	Qty 2	Qty 1	UOM
		mm	mm	inch	inch	mm	mm	mm	mm			
1070655	16-Rp1/2"FT-16 l=25	49	57	3/4	1/2	19	37	45	50	5	1	pce
1070656	16-Rp1/2"FT-16 l=35	59	57	3/4	1/2	19	37	45	50	5	1	pce

Uponor Smart Aqua tap elbow mount. plate

- Made of galvanized steel.
- For the installation of Uponor Smart Aqua tap elbows
- Positioning of the connections in the given raster
- Plastic pins and loss protected screws M6x12 acc. DIN 965 included
- With holes and slots for easy attachment

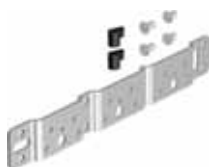

Item no.	Dimension	l	s	h	k	k1	w	Qty 2	Qty 1	UOM
		mm	mm	mm	mm	mm	mm			
1057840	75/150mm	265	3,0	9	75	150	35	5	1	pce

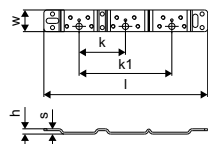

Uponor S-Press PLUS

Uponor Smart Aqua mounting angle

- Made of galvanized steel.
- For the installation of Uponor Smart Aqua tap elbows
- Positioning of the connections in the given raster
- Plastic pins and loss protected screws M6x12 acc. DIN 965 included
- With holes and slots for easy attachment

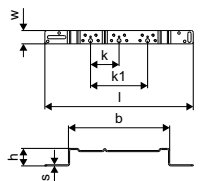

Item no.	Dimension	l mm	s mm	b mm	h mm	k mm	k1 mm	w mm	Qty 2	Qty 1	UOM
1057841	80mm	320	3	196	46	80		35	5	1	pce
1057839	100mm	340	3	216	46	100		35	5	1	pce
1057842	75/150mm	390	3	266	46	75	150	35	5	1	pce

Uponor Smart Aqua single mounting angle

- Made of galvanized steel.
- For the installation of Uponor Smart Aqua tap elbows.
- Positioning of the connections in the given raster.
- Screws M6x12 acc. DIN 965 included. With holes and slots for easy attachment

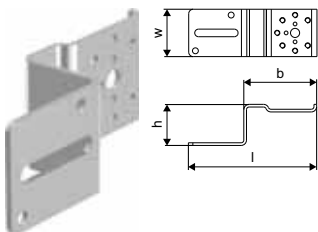

Item no.	l mm	b mm	h mm	Qty 2	Qty 1	UOM
1057843	144	82	46	5	1	pce

Uponor Smart Aqua mounting rack

- Made of galvanized steel.
- For the installation of Uponor Smart Aqua tap elbows.
- Positioning of the connections in the given raster.
- Screws M6x12 acc. DIN 965 included. With holes and slots for easy attachment

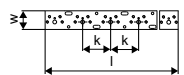

Item no.	Dimension	l mm	k mm	Qty 2	Qty 1	UOM
1057844	2m	2000	75	10	1	pce

Uponor S-Press PLUS

Uponor Smart Aqua 10 pins+20 screws

- Pins and screws for mounting plates, angles and tracks.

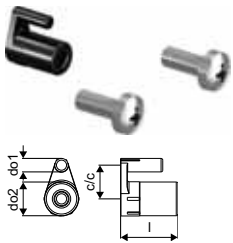

Item no.	l mm	do1 mm	do2 mm	c/c1 mm	Qty 1	UOM
1057847*	17	4	10	10	1	set

Uponor Smart Aqua mounting rack bending tool

- For bending the 2 meter long mounting track.



Item no.	Dimension	Qty 2	Qty 1	UOM
1015424	2m	100	1	pce

Uponor S-Press PLUS adapter

- Unique press indicator
- Fast 3-step installation (press without bevel)
- Innovative QR code for immediate digital access
- With soldered copper pipe according EN 1057 (half hard / R250)
- complete tin-plated
- Attention:

The copper side is for press connections and suitable compression fittings only.

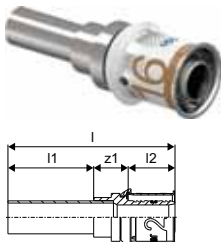

Item no.	Dimension	l mm	l1 mm	l2 mm	z1 mm	Qty 2	Qty 1	UOM
1070615	16-15CU	76	40	20	16	160	20	pce
1070707	20-15CU	76	39	21	16	3840	10	pce
1070617	20-22CU	81	41	21	19	60	15	pce
1070618	25-22CU	88	41	28	19	20	5	pce
1070619	25-28CU	92	43	28	21	1920	5	pce
1070620	32-28CU	92	43	28	21	20	5	pce

Uponor S-Press PLUS radi crossing insulated

- Unique press indicator
- Fast 3-step installation (press without bevel)
- Innovative QR code for immediate digital access
- For cross-over-free connection of a radiator on the raw floor
- Incl. insulation box, consisting of upper and lower part made of EPP (expanded polypropylene) with 13 mm insulation layer (corresponds to 50 % insulation in compliance with EnEV), WLG 035. Meets EnEV requirements in respect of pipe cross-overs and wall penetrations!
- Dimensions of insulation box
(Length x Width x Height): 115 x 115 x 55 mm.

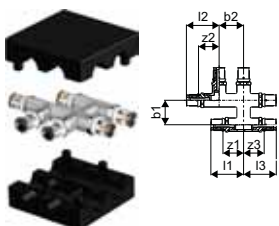

Item no.	Dimension	l1 mm	l2 mm	l3 mm	s mm	z1 mm	z2 mm	z3 mm	b1 mm	b2 mm	Qty 2	Qty 1	UOM
1070689	16-16-16	54	54	54	40,0	34	34	34	40	40	192	1	pce
1070690	20-16-16	56	56	55	40,0	34	34	34	40	40	192	1	pce
1070691	20-16-20	56	55	55	40,0	34	34	34	40	40	192	1	pce
1070692	20-20-20	56	56	56	40,0	34	34	34	40	40	192	1	pce

Uponor S-Press PLUS

Uponor Smart Radi connection unit box

- Made of polystyrene with removable protective cap (WLS 040)
- Insulation box, flame resistant, B1 acc. to DIN 4102
- 100% acc. EnEV in outer wall

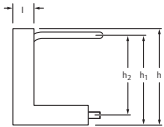

Item no.	Dimension	d mm	l mm	b mm	h mm	h1 mm	h2 mm	Qty 2	Qty 1	UOM
1013134	16 h=215mm	16	50	100	260	240	215	240	10	pce
1007077	16 h=240mm	16	50	100	285	265	240	240	10	pce

Uponor S-Press PLUS radi elbow adapter plated

- With copper pipe 15 x 1 mm and 22 x 1 mm, plated.
- The connection of the plated copper pipe 15 x 1 mm to the radiator can be made with the Uponor clamp compression adapter Cu (Item-No. 1013830).

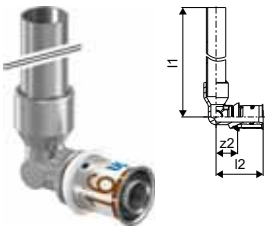

Item no.	Dimension	l1 mm	l2 mm	z1 mm	Qty 2	Qty 1	UOM
1070678	16-15CU l=350mm	366	37	17	1680	20	pce
1070679	16-15CU l=1000mm	1116	37	17	400	20	pce

Uponor S-Press PLUS radi tee adapter plated

- With cranked copper pipe 15 x 1 mm, plated
- The connection of the plated copper pipe 15 x 1 mm to the radiator can be made with the Uponor clamp compression adapter Cu (Item-No. 1013830).

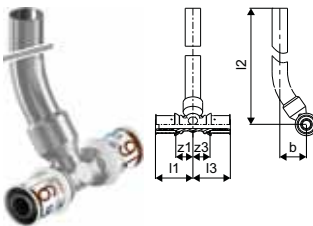

Item no.	Dimension	l1 mm	l2 mm	l3 mm	z1 mm	z3 mm	b mm	Qty 2	Qty 1	UOM
1070681	16-15CU-16 l=350mm	38	351	38	18	18	26	600	20	pce
1070682	20-15CU-20 l=350mm	40	353	40	19	19	27	600	20	pce

Uponor Smart Radi adapter plated

- Made of coated copper pipe
- copper pipe 15 x 1 mm with self sealing thread for the connection to radiator
- Fits to all Uponor press tap elbow MLC, press tap wall plate MLC and press female connection 1/2" MLC
- Connection to the radiator with the Uponor eurocone compression adapter Cu.

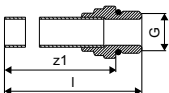

Item no.	Dimension	l mm	G inch	z1 mm	Qty 2	Qty 1	UOM
1015425	G1/2"MT-15CU l=350mm	369	1/2	356	640	20	pce

Uponor S-Press PLUS

Uponor Smart Radi adapter

- With 3/4FT eurocone, elastically sealing, for the connection of the coated copper pipe 15 x 1 mm of the Uponor press connection elbow, Uponor press connection tee to the tap battery, radiator or Uponor radiator connection adapter with 3/4FT eurocone.
- Coated brass union nut, brass clamp ring blank and sealing cone made of EPDM.
- Ribbed union nut with wrench size 27.

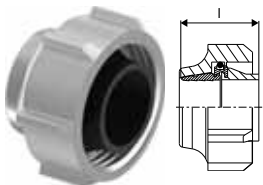

Item no.	Dimension	l mm	Qty 2	Qty 1	UOM
1013830	15CU-3/4" Euro	21	80	10	pce

Uponor Smart Radi adapter sealed

- Made of coated brass
- self-sealing
- For the connection of radiators with 1/2 female thread connectors, 3/4 male thread eurocone for the connection of Cu-pipe, 15 x 1 mm, with clamp compression adapter.



Item no.	Dimension	l mm	G inch	G1 inch	Qty 2	Qty 1	UOM
1013906	G3/4"MT-G1/2"MT	34	3/4	1/2	80	10	pce

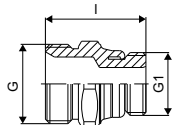

Uponor Smart Radi compr. connection set Danfoss

- Made of coated brass
- pressure screw with male thread, with inner sleeve and clamp ring, fit to Danfoss radiator valves with female thread
- O-Ring, blue, made of EPDM.



Item no.	Dimension	l mm	l1 mm	G inch	z1 mm	Qty 2	Qty 1	UOM
1013970	16-G1/2"MT	37	29	1/2	8	20	1	pce

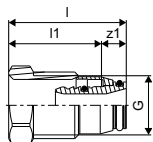

Uponor S-Press PLUS

Uponor Smart Radi compr. connection set Heimeier

- Made of coated brass
- pressure screw with male thread, with inner sleeve and clamp ring, fit to Heimeier radiator valves with female thread
- O-Ring, grey, made of EPDM.



Item no.	Dimension	l	l1	G	z1	Qty 2	Qty 1	UOM
		mm	mm	inch	mm			
1013978	16-G1/2"MT	34	28	1/2	6	20	1	pce

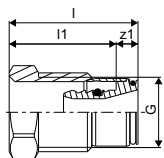

Uponor Smart Radi cover plate dividable

- Made of polypropylene, white
- for Uponor Uni Pipe PLUS and MLC pipes
- Required distance (pipe middle - middle) between two snap rings, e.g. for supply and return of the heating line approx. 50 mm.
- Fire classification E acc. to EN 13501-1.



Item no.	Dimension	Qty 2	Qty 1	UOM
1011370	16 white	20000	50	pce
1011372	20 white	16000	50	pce

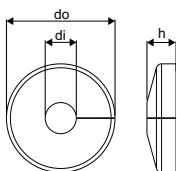

Uponor Smart Radi cover plate dividable

- Made of polypropylene white
- for Uponor Uni Pipe PLUS and MLC pipes 14 - 20 mm, to cover floor and/or wall penetration of the radiator connection pipe line
- Required inside micrometer (pipe middle - middle) between two Uponor MLC pipes for supply and return flow: 50 mm. The cascaded penetrations can be severed easily with a knife according to desired pipe dimension.
- The snap ring consists of two halves, which are pressed together with two push buttons by hand
- Fire classification B2 acc. to EN 13501-1.



Item no.	Dimension	Qty 2	Qty 1	UOM
1011373	14-20 white double	500	50	pce

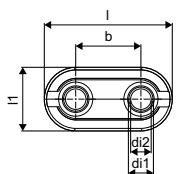

Uponor RS

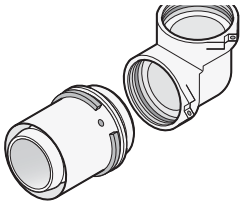

Uponor RS is a unique system that follows a modular design principle for riser systems and other distribution lines. Just 40 system components enable hundreds of variations, making the system highly adaptable.

Your benefits

- Innovative plug connection between body and adapter
- Fast and flexible: tool-free assembly, many variations
- More efficient stock management
- Re-adjustment possible until final installation
- Colour coding 16 -110mm for easy dimension selection



Specification

- with fixed press sleeve
- stop ring
- colour code
- Test safety

Application

- Tap water: The permanent operating temperature ranges from 0°C to 70°C at a maximum permanent operating pressure of 10 bar. The short-term malfunction temperature is 95°C for a period of 100 hours in the operating life time.
- Heating: The permanent operating temperature ranges up to 80°C at a maximum permanent operating pressure of 10 bar. The short-term malfunction temperature is 100°C for a period of 100 hours in the operating life time.

if not different mentioned:

- Male and female threads acc.to EN 10226-1.

Certification

- Approvals by local OM.

Uponor RS coupling

- Made of tin-plated brass
- Base part for all RS2 or RS3 inserts including 2 lock pins.

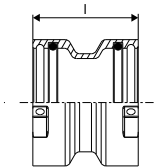

Item no.	Dimension	l mm	Qty 2	Qty 1	UOM
1029144	RS2-RS2	58	480	1	pce
1029145	RS3-RS3	58	480	1	pce

Uponor RS

Uponor RS elbow

- Made of tin-plated brass
- Base part for all RS2 or RS3 inserts including 2 lock pins.

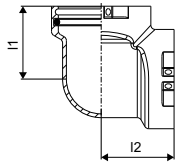

Item no.	Dimension	I1 mm	I2 mm	Qty 2	Qty 1	UOM
1029138	RS2-RS2	51	51	336	1	pce
1029139	RS3-RS3	68	68	240	1	pce

Uponor RS elbow 45°

- Made of tin-plated brass
- Base part for all RS2 or RS3 inserts including 2 lock pins.

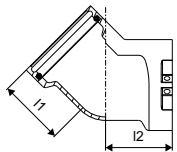

Item no.	Dimension	I1 mm	I2 mm	Qty 2	Qty 1	UOM
1029140	RS2-RS2	51	51	336	1	pce
1029141	RS3-RS3	68	68	175	1	pce

Uponor RS tee

- Made of tin-plated brass
- Base part for all RS2 or RS3 inserts including 3 lock pins.

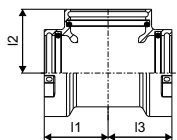

Item no.	Dimension	I1 mm	I2 mm	I3 mm	Qty 2	Qty 1	UOM
1029142	RS2-RS2-RS2	51	51	51	336	1	pce
1029143	RS3-RS3-RS3	68	68	68	175	1	pce

Uponor RS reducer

- Made of tin-plated brass
- Reducer from RS3 to RS2 including 1 lock pin.

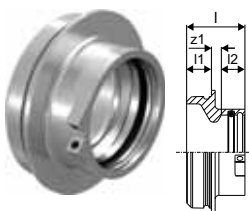

Item no.	Dimension	I mm	I1 mm	I2 mm	z1 mm	Qty 2	Qty 1	UOM
1029146	RS3-RS2	47	20	19	8	480	1	pce

Uponor RS

Uponor RS spacer

- Made of tin plated-brass
- Spacer to connect RS base parts of equal dimensions.

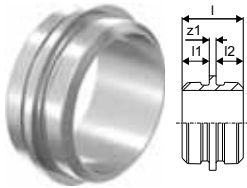

Item no.	Dimension	l mm	l1 mm	l2 mm	z1 mm	Qty 2	Qty 1	UOM
1046750	RS2-RS2 l=5mm	45	20	20	5	480	1	pce
1046751*	RS3-RS3 l=5mm	45	20	20	5	240	1	pce

Uponor RS spacer

- Made of tin-plated brass
- Spacer to connect RS base parts of equal dimensions e.g. to create T-manifold or shift in distribution lines.



Item no.	Dimension	l mm	l1 mm	l2 mm	l3 mm	z1 mm	Qty 2	Qty 1	UOM
1046477*	RS2-RS2 l=130mm	170	20	20	30	130	240	1	pce
1046478*	RS3-RS3 l=210mm	250	20	20	30	210	96	1	pce

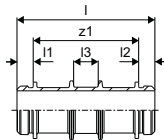

Uponor RS adapter S-Press

- Made of tin-plated brass
- Fits to all RS2 base parts.

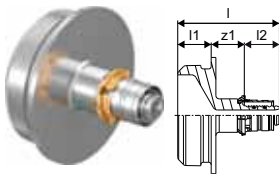

Item no.	Dimension	l mm	l1 mm	l2 mm	z1 mm	Qty 2	Qty 1	UOM
1059397	16-RS2	61	20	21	20	480	1	pce

Uponor RS adapter S-Press PLUS

- tin plated
- made of DR material
- press without bevel



Item no.	Dimension	l mm	l1 mm	l2 mm	z1 mm	Qty 2	Qty 1	UOM
1095818	20-RS2	61	20	21	20	378	1	pce
1095819	25-RS2	75	20	28	27	378	1	pce
1095820	32-RS2	75	20	28	27	378	1	pce

Uponor RS

Uponor RS adapter S-Press

- Made of tin-plated brass
- Fits to all RS2 or RS3 base parts.

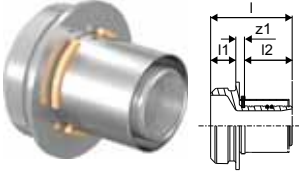

Item no.	Dimension	l mm	l1 mm	l2 mm	z1 mm	Qty 2	Qty 1	UOM
1046940	40-RS2	65	20	38	7	480	1	pce
1046941	50-RS2	65	20	38	7	480	1	pce
1029125	63-RS2	88	20	61	7	400	1	pce
1029126	75-RS2	88	20	61	7	400	1	pce
1029127	90-RS3	93	20	62	11	240	1	pce
1029128	110-RS3	93	20	62	11	240	1	pce

Uponor RS adapter male thread

- Made of tin-plated brass
- Fits to all RS2 or RS3 base parts



Item no.	Dimension	l mm	l1 mm	l2 mm	R inch	z1 mm	Qty 2	Qty 1	UOM
1059402	R1 1/2"MT-RS2	62	20	24	1 1/2	18	480	1	pce
1029131	R2"MT-RS2	66	20	23	2	23	480	1	pce
1029132	R2 1/2"MT-RS2	63	20	27	2 1/2	16	480	1	pce
1029133	R3"MT-RS3	73	20	30	3	23	240	1	pce

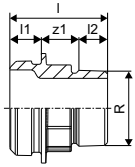

Uponor RS adapter female thread

- Made of tin-plated brass.
- fits to all RS2 or RS3 base parts



Item no.	Dimension	l mm	l1 mm	l2 mm	Rp inch	z1 mm	Qty 2	Qty 1	UOM
1059403	Rp1 1/2"FT-RS2	42	20	15	1/2	7	480	1	pce
1029134	Rp1"FT-RS2	45	20	19	1	6	480	1	pce
1029135	Rp2"FT-RS2	54	20	26	2	8	480	1	pce
1029136	Rp2 1/2"FT-RS2	63	20	30	2 1/2	12	480	1	pce
1059404	Rp1 1/2"FT-RS3	43	20	15	1/2	8	336	1	pce
1029137	Rp3"FT-RS3	65	20	33	3	12	240	1	pce

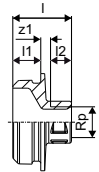

Uponor RS

Uponor RS flange adapter

- Made of tin-plated brass
- Fits to all RS2 or RS3 base parts
- Flange PN6/PN16 acc. to EN 1092-3
- Bolt circle with 4/8 holes.

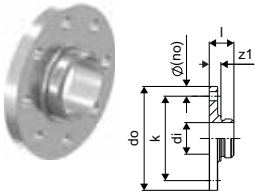

Item no.	Dimension	l mm	di mm	do mm	z1 mm	k mm	p bar	Qty 2	Qty 1	UOM
1059398	RS2-DN65 (PN6)	38	48,7	160	18	130	6	144	1	pce
1059399*	RS2-DN65 (PN16)	45	48,7	185	25	145	16	90	1	pce
1059400	RS3-DN80 (PN6)	38	78,1	190	18	150	6	90	1	pce
1029129*	RS3-DN80 (PN16)	45	78,1	200	25	160	16	90	1	pce
1059401	RS3-DN100 (PN6)	41	78,1	210	21	170	6	90	1	pce
1029130	RS3-DN100 (PN16)	44	78,1	220	24	180	16	90	1	pce

Uponor RS lock pin

- made of plastic
- to lock the RS insert to the RS base part.



Item no.	Dimension	colour	Qty 2	Qty 1	UOM
1042921	RS2 black	black	5000	10	pce
1042922	RS3 grey	grey		10	pce

Uponor RTM

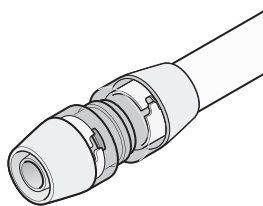

Uponor RTM fittings are designed to be tool independent and work with selected Uponor pipes to create perfect pipe connections. They are quick to use, secure, and result in a long-lasting, leak-free joint.

RTM fittings work perfectly for tap water and heating/cooling application.

Your benefits

- Consistent pressure around pipe
- Colour coded joint indicator
- No tool dependence
- Joint indicator: visible and audible
- Fast and easy installation



Specification

- tool inside concept
- pressed identification
- colour code

Application

- Tap water: The permanent operating temperature ranges from 0°C to 70°C at a maximum permanent operating pressure of 10 bar. The short-term malfunction temperature is 95°C for a period of 100 hours in the operating life time.
- Heating: The permanent operating temperature ranges up to 80°C at a maximum permanent operating pressure of 10 bar. The short-term malfunction temperature is 100°C for a period of 100 hours in the operating life time.

Certification

- Approvals by local OM.

Uponor RTM coupling PPSU

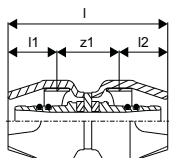

Item no.	Dimension	l	l1	l2	z1	Qty 2	Qty 1	UOM
		mm	mm	mm	mm			
1048542	16-16	60	18	18	24	40	1	pce

Uponor RTM

Uponor Flex con. valve, long handle

- Chrome plated lever and cover rosette.
- For Concealed valves.

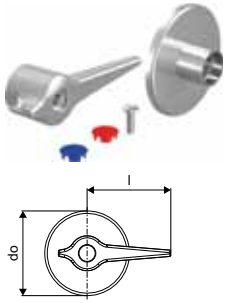

Item no.	l mm	do mm	Qty 2	Qty 1	UOM
1023161	67	67,8	10	10	pce

Uponor Flex con valve, public handle

- Chrome plated lever and cover rosette.
- For Concealed valves.

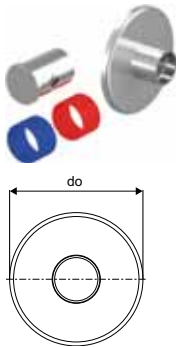

Item no.	do mm	Qty 2	Qty 1	UOM
1023162	67,8	10	1	pce

Uponor Flex con valve, wheel handle

- For Concealed valves.



Item no.	Qty 2	Qty 1	UOM
1038462	10	1	pce

Uponor Flex con valve handle extension

- For Concealed valves.



Item no.	Qty 2	Qty 1	UOM
1023163	520	10	pce

Uponor Uni-X

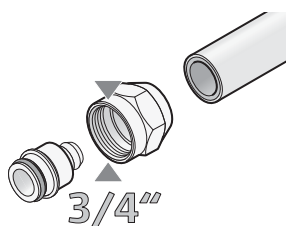

Uponor Uni-X is a compression fittings range of 3/4" eurocone connectors, metrical conus and adaptors for tap water and heating/cooling application.

Your benefits

- Simple adaption to other pipes and systems
- Flexible system design
- No special tools required



Application

- For the distribution of heating water for the radiator connection

Uponor Uni-X compression adapter MLC

- Compression adapter, union nut and inner sleeve
- made of brass
- For connection of Uponor Uni Pipe PLUS and MLC pipes to manifolds (eg. Uponor manifold H).
- Female thread 3/4" eurocone according to EN ISO 228-1

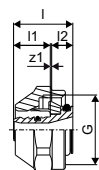

Item no.	Dimension	l	l1	G	z1	Qty 2	Qty 1	UOM
		mm	mm	inch	mm			
1058089	14-3/4"FT Euro	23	13	3/4	3	25	1	pce
1058090	16-3/4"FT Euro	23	13	3/4	3	25	1	pce
1058092	20-3/4"FT Euro	24	14	3/4	3	25	1	pce
1058093	25-3/4"FT Euro	27	14	3/4	7	25	1	pce

Uponor Uni-X compr. coupling, renovation

- Connection set for Uponor Uni Pipe PLUS or MLC pipes to third party pipes for renovation purpose
- Compression adapter made of brass, 3/4 Uponor euro cone coupling nipple and compression adapter MLC tin-plated brass
- Note: Only for renovation.

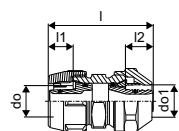

Item no.	Dimension	l	l1	l2	do	do1	Qty 2	Qty 1	UOM
		mm	mm	mm	mm	mm			
1048745	16x2,0-16x2,0	53	14	14	16	16	10	1	set
1048746	16x2,0-16x2,25	53	14	14	16	16	10	1	set
1048747	20x2,25-20x2,25	53	14	14	20	20	10	1	set
1048748	20x2,25-20x2,5	53	14	14	20	20	10	1	set

Uponor Uni-X

Uponor Uni-X compression adapter MLC

- Compression adapter, union nut and inner sleeve made of brass
- For connection of Uponor Uni Pipe PLUS and MLC pipes to radiator valves similar to Comap and Herz with M22 threads.
- No bevel.

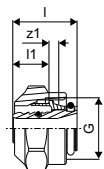

Item no.	Dimension	l	l1	l2	M	z1	Qty 2	Qty 1	UOM
1058094	16-M22	23	13		22	4	25	1	pce

Uponor Uni-X compression adapter MLC

- Compression adapter, union nut and inner sleeve made of brass
- For connection of Uponor MLC pipes to radiator valves similar to Oventrop and Heimeier with M24x1,5 threads
- No bevel.

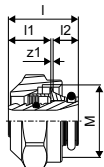

Item no.	Dimension	l	l1	M	z1	Qty 2	Qty 1	UOM
1058095	16-M24	23	13	24	4	25	1	pce

Uponor Uni-X coupling male thread

- Made of tin-plated brass
- Female thread acc.to EN 10226-1
- Male thread acc. to EN ISO 228-1.

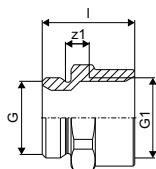

Item no.	Dimension	l	G	G1	z1	Qty 2	Qty 1	UOM
1014143	3/4"MT-3/4"FT Euro	31	3/4	3/4	8	80	10	pce

Uponor Uni-X

Uponor Uni-X coupling plated

- Made of tin-plated brass
- Male thread acc. to EN ISO 228-1.

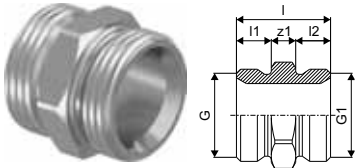

Item no.	Dimension	l	l1	l2	G	G1	z1	Qty 2	Qty 1	UOM
		mm	mm	mm	inch	inch	mm			
1006641	G3/4"MT Euro-G3/4"MT Euro	27	10	10	3/4	3/4	7	80	20	pce

Uponor Uni-X elbow male thread

- Made of tin-plated brass
- Male thread acc. to EN ISO 228-1.

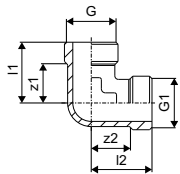

Item no.	Dimension	l1	l2	G	G1	z1	z2	Qty 2	Qty 1	UOM
		mm	mm	inch	inch	mm	mm			
1014145	3/4"MT-3/4"MT Euro	30	30	3/4	3/4	19	19	80	10	pce

Uponor Uni-X tee male thread

- Made of tin-plated brass
- Male thread acc. to EN ISO 228-1.

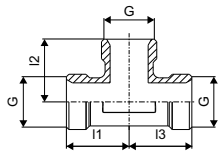

Item no.	Dimension	l1	l2	l3	G	G1	G2	Qty 2	Qty 1	UOM
		mm	mm	mm	inch	inch	inch			
1014147	3/4"MT-3/4"MT-3/4"MT	30	30	30	3/4	3/4	3/4	40	10	pce

Uponor Uni-X

Uponor Uni-X manifold H 1"SN

- Manifold made of stainless steel
- Flat-sealing connection 1" female thread including flat seal

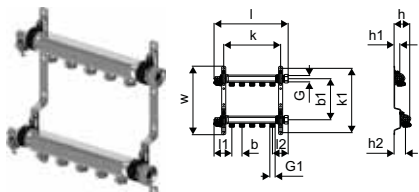

Item no.	Dimension	outlets	l	l1	l2	G	G1	b	b1	b2	h	h1	h2	k	k1	w	p	Qty 2	Qty 1	UOM	
		-	mm	mm	mm	inch	inch	mm	mm	mm	mm	mm	mm	mm	mm	mm	mm	bar			
1088873	2xG3/4 Euro	2	210	87	73	1	3/4	50	215	215	75	30	50	135	336	357	6	108	1	pce	
1088874	3XG3/4 Euro	3	260	87	73	1	3/4	50	215	215	75	30	50	185	336	357	6	108	1	pce	
1088875	4XG3/4 Euro	4	310	87	73	1	3/4	50	215	215	75	30	50	235	336	357	6	108	1	pce	
1088876	5XG3/4 Euro	5	360	87	73	1	3/4	50	215	215	75	30	50	285	336	357	6	108	1	pce	
1088877	6XG3/4 Euro	6	410	87	73	1	3/4	50	215	215	75	30	50	335	336	357	6	72	1	pce	
1088878	7XG3/4 Euro	7	460	87	73	1	3/4	50	215	215	75	30	50	385	336	357	6	72	1	pce	
1088879	8XG3/4 Euro	8	510	87	73	1	3/4	50	215	215	75	30	50	435	336	357	6	72	1	pce	
1088880	9XG3/4 Euro	9	560	87	73	1	3/4	50	215	215	75	30	50	485	336	357	6	72	1	pce	
1088881	10XG3/4 Euro	10	610	87	73	1	3/4	50	215	215	75	30	50	535	336	357	6	48	1	pce	
1088882	11XG3/4 Euro	11	660	87	73	1	3/4	50	215	215	75	30	50	585	336	357	6	48	1	pce	
1088883	12XG3/4 EURO	12	710	87	73	1	3/4	50	215	215	75	30	50	635	336	357	6	48	1	pce	

Uponor Vario ball valve

- Made of brass, nickel-plated

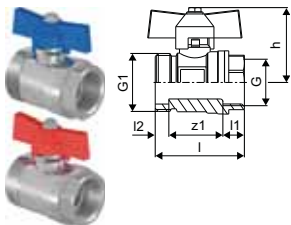

Item no.	Dimension	l	l1	l2	l3	G	G1	z1	Qty 2	Qty 1	UOM
		mm	mm	mm	mm	inch	inch	mm			
1086558	3/4-G1	51	12	8	43	3/4	1	31	10	1	set

Uponor Vario ball valve

- Made of brass nickel-plated
- For flat sealing vertical connection G1
- 60 mm + length of the manifold



Item no.	Dimension	AG	IG	Qty 2	Qty 1	UOM
		inch	inch			
1059132	NP G1-G1	1	1	10	1	set

Uponor Uni-X

Uponor Vario ball valve elbow

- Made of brass, nickel-plated

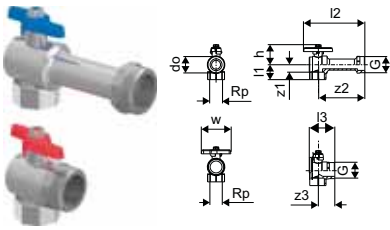

Item no.	Dimension	l1	l2	l3	do	G	Rp	z1	z2	z3	h	w	Qty	UOM
		mm	mm	mm	mm	inch	inch	mm	mm	mm	mm	mm	1	
1086559	Rp 3/4" - G1"	31	95	94	33	1	3/4	22	88	27	43	60	1	set

Uponor Uni-C

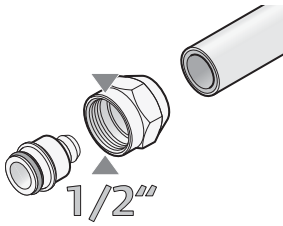

Uponor Uni-C 1/2" threaded compression manifolds made of tin-plated brass is a range of fittings and adaptors designed for tap water and heating/cooling application.

Your benefits

- Easily adaptable to other systems
- Installation flexibility
- No special tools required



Uponor Uni-C manifold male female thread S

- Made of tin-plated brass
- with connection 1" for male thread or female thread, outlets 1/2" male thread fits to Uponor compression adapter.

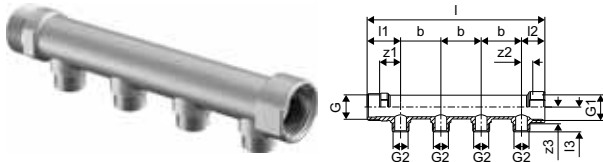

Item no.	Dimension	outlets	l	l1	l2	l3	G	G1	G2	z1	z2	z3	b	Qty 2	Qty 1	UOM
		-	mm	mm	mm	mm	inch	inch	inch	mm	mm	mm	mm			
1014107*	1"MT/FT 2X1/2"MT	2	121	42	29	31	1	1	1/2	26	14	21	50	1218	1	pce
1014111*	1"MT/FT 3X1/2"MT	3	171	42	29	31	1	1	1/2	26	14	21	50	854	1	pce
1014109*	1"MT/FT 4X1/2"MT	4	220	42	29	31	1	1	1/2	26	14	21	50	679	1	pce

Uponor Uni-C male female, valve SH

- Made of tin-plated brass.
- With connection 1" for male thread or female thread
- outlets 1/2" male thread and valves to close each outlet separate.
- Corresponding compression adapters for connecting the Uponor MLC pipes from the basic assortment.

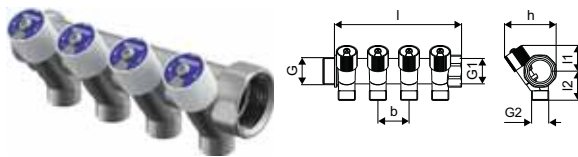

Item no.	Dimension	outlets	l	l1	l2	G	G1	G2	b	h	Qty 2	Qty 1	UOM
		-	mm	mm	mm	inch	inch	inch	mm	mm			
1014137	1"MT/FT 2X1/2"MT c/c38mm	2	79	31	36	1	1	1/2	38	63	30	6	pce
1014138	1"MT/FT 3X1/2"MT c/c38mm	3	117	31	36	1	1	1/2	38	63	20	4	pce
1014139	1"MT/FT 4X1/2"MT c/c38mm	4	155	31	36	1	1	1/2	38	63	15	3	pce

Uponor Uni-C manifold bracket S

- Supplied as a single bracket
- Made of galvanised steel, for the sound absorbing installation of Uponor Uni-C manifold male female thread S.



Item no.	l	a	a1	Qty 2	Qty 1	UOM
	mm	mm	mm			
1014117	47	210	36	25	1	pce

Uponor Uni-C

Uponor Uni-C bracket SH

- Manifolds and accessories



Item no.	Dimension	Qty 2	Qty 1	UOM
1045451	3/4" 1"	25	1	set

Uponor Uni-C manifold end plug male S/SH PL

- Made of plated brass
- for manifold S/SH.

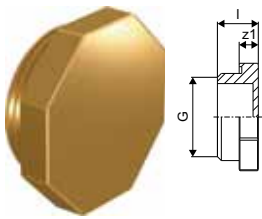

Item no.	Dimension	l mm	G inch	z1 mm	Qty 2	Qty 1	UOM
1014123	1"MT	16	1	7	100	20	pce

Uponor Uni-C end plug O-ring

- Made of plated brass
- with sealing O-Ring.



Item no.	Dimension	l mm	z mm	Qty 2	Qty 1	UOM
1002274	1"MT	16	9	20	10	pce

Uponor Uni-C manifold end cap female S/SH PL

- Made of plated brass
- including seal for the manifold S/SH.

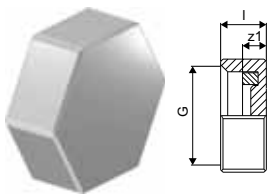

Item no.	Dimension	l mm	G inch	z1 mm	Qty 2	Qty 1	UOM
1014120	G1/2"FT	10	1/2	5	80	20	pce
1014121*	G1"FT	12	1	4	120	20	pce

Uponor Uni-C

Uponor Uni-C compression adapter MLC

- Compression adapter, union nut and inner sleeve made of brass
- For connection of Uponor Uni Pipe PLUS and MLC pipes to manifolds (e.g. Uponor manifold S, SH)
- Female thread 1/2" according to EN ISO 228-1
- No bevel.



Item no.	Dimension	l	l1	G	z1	Qty 2	Qty 1	UOM
		mm	mm	inch	mm			
1058086	16-1/2"FT	23	13	1/2	4	25	1	pce
1058088	20-1/2"FT	26	14	1/2	7	25	1	pce

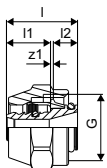

Uponor Uni-C coupling plated MLC

- Made of tin-plated brass
- Male thread acc.to DIN EN ISO 228-1



Item no.	Dimension	l	G	G1	z1	Qty 2	Qty 1	UOM
		mm	inch	inch	mm			
1013894	1/2"MT-1/2"MT	29	1/2	1/2	6	160	40	pce

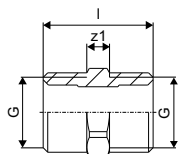

Uponor Uni-C elbow plated MLC

- Made of tin-plated brass
- Male thread acc.to DIN EN ISO 228-1



Item no.	Dimension	l1	l2	G	G1	z1	z2	Qty 2	Qty 1	UOM
		mm	mm	inch	inch	mm	mm			
1013914	G1/2"MT-G1/2"MT	29	29	1/2	1/2	18	18	80	20	pce

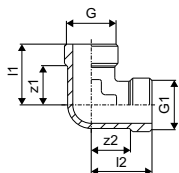

Uponor Uni-C

Uponor Uni-C elbow adapter plated MLC

- Made of tin-plated brass
- Male thread acc.to DIN EN ISO 228-1
- Female thread acc.to DIN EN 10226-1.

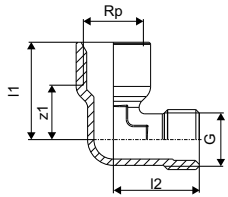

Item no.	Dimension	l1	l2	G	Rp	z1	Qty 2	Qty 1	UOM
		mm	mm	mm	inch	inch			
1013932	G1/2"MT-Rp1/2"FT	34	30	1/2	1/2	19	80	10	pce

Uponor Smart Aqua tap elbow Uni-C

- Made of tin-plated brass
- For on wall installation or attachment with rotation protection to the MLCP mounting angles and plate
- Male thread acc. to DIN EN ISO 228-1.

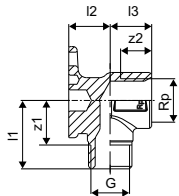

Item no.	Dimension	l1	l2	l3	Rp	R	z1	z2	Qty 2	Qty 1	UOM
		mm	mm	mm	inch	inch	mm	mm			
1015559	1/2"MT-1/2"FT	33	20	20	1/2	1/2	22	5	40	10	pce

Uponor Aqua Pipe

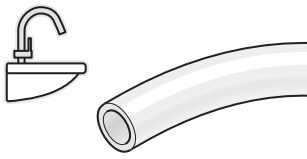

Uponor Aqua Pipe is manufactured from highest quality cross-linked polyethylene and is designed for tap water application as well as distribution pipes.

Your benefits

- Certified quality
- Corrosion resistant
- Thermal memory
- Lightweight and very flexible
- Durable



Specification

- Pipes manufactured from peroxide cross-linked polyethylene (PE-Xa) acc. EN ISO 15875
- Application class 2 - Hot water supply
- Fire classification E according to DIN EN 13501-1.
- Conduits manufactured from high density polyethylene

Application

- Tap water: The permanent operating temperature ranges from 0°C to 70°C. The short-term malfunction temperature is 95°C for a period of 100 hours in the operating life time.

Uponor Aqua Pipe natural PN6

- Operating pressure 6 bar
- Coils

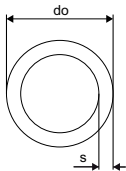

Item no.	Dimension	L m	do mm	s mm	p mm	colour	Qty 2	Qty 1	UOM
1008386	16x2,0 100m	100	16	2	6	natural	1100	100	m
1008408	20x2,0 100m	100	20	2	6	natural	700	100	m
1017870	25x2,3 100m	100	25	2,3	6	natural	500	100	m
1048757	32x2,9 50m	50	32	2,9	6	natural	550	50	m
1033417	40x3,7 50m	50	40	3,7	6	natural	250	50	m
1033481	50x4,6 50m	50	50	4,6	6	natural	250	50	m
1033502	63x5,8 50m	50	63	5,8	6	natural		50	m
1033520	75x6,8 50m	50	75	6,9	6	natural		50	m

Uponor Aqua Pipe natural PN10

- Operating pressure 10 bar
- Coils

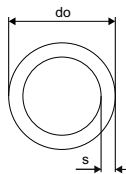

Item no.	Dimension	L m	do mm	s mm	p mm	colour	Qty 2	Qty 1	UOM
1022682	16x2,2 100m	100	16	2,2	10	natural	1100	100	m
1001201	20x2,8 50m	50	20	2,8	10	natural	550	50	m
1001202	25x3,5 50m	50	25	3,5	10	natural	400	50	m
1001203	32x4,4 50m	50	32	4,4	10	natural	350	50	m
1008963*	40x5,5 50m	50	40	5,5	10	natural	350	50	m
1008964*	50x6,9 50m	50	50	6,9	10	natural		50	m

Uponor Aqua Pipe

Uponor Aqua Pipe natural PN10 S

- Operating pressure 10 bar
- Straight bars

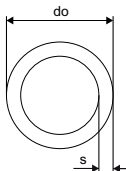

Item no.	Dimension	L m	do mm	s mm	p bar	colour	Qty 2	Qty 1	UOM
1001206	32x4,4 6m	6	32	4,4	10	natural	1080	12	m
1033864	40x5,5 6m	6	40	5,5	10	natural	60	6	m
1033865	50x6,9 6m	6	50	6,9	10	natural	30	6	m
1023122	63x8,6 6m	6	63	8,6	10	natural	420	6	m
1033866	90x12,3 6m	6	90	12,3	10	natural		6	m

Uponor Aqua Pipe in conduit

Specification

- Pipes manufactured from peroxide cross-linked polyethylene (PE-Xa) acc. EN ISO 15875
- Application class 2 - Hot water supply
- Fire classification E according to DIN EN 13501-1.
- Conduits manufactured from high density polyethylene

Application

- Tap water: The permanent operating temperature ranges from 0°C to 70°C at a maximum permanent operating pressure of 10 bar. The short-term malfunction temperature is 95°C for a period of 100 hours in the operating life time.
- Leakage free tap water installations with possibility to exchange pipes in case of damage

Uponor Aqua Pipe natural in conduit black

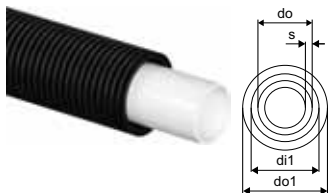

Item no.	Dimension	L m	di1 mm	do mm	do1 mm	s mm	p bar	colour	Qty 2	Qty 1	UOM
1008993	16x2,2 25/20 50m	50	20	16	25	2,2	10	black	550	50	m
1008994	20x2,8 28/23 50m	50	23	20	28	2,8	10	black	400	50	m
1008995	25x3,5 34/28 50m	50	28	25	34	3,5	10	black	300	50	m

Uponor Radi Pipe

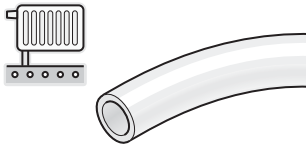

Uponor Radi Pipe is manufactured using the highest quality cross-linked polyethylene and is designed for radiator connections as well as distribution pipes in heating/cooling application.

Your benefits

- Certified quality
- Thermal memory
- Lightweight, very flexible
- Durable
- Oxygen diffusion tight



Specification

- Pipes manufactured from peroxide cross-linked polyethylene (PE-Xa) acc. EN ISO 15875
- EVOH (ethylene vinyl alcohol) layer for oxygen diffusion resistance as per DIN 4726
- Application class 5 - high temperature radiators
- Fire classification E according to DIN EN 13501-1.

Application

- Heating: The permanent operating temperature ranges up to 90°C. The short-term malfunction temperature is 100°C for a period of 100 hours in the operating life time.

Uponor Radi Pipe natural PN6

- Operating pressure 6 bar
- Coils

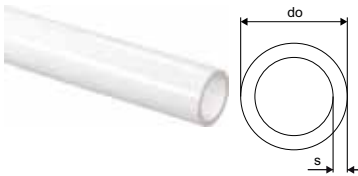

Item no.	Dimension	L m	do mm	s mm	p bar	colour	Qty 2	Qty 1	UOM
1047610	16x2,0 120m	120	16	2	6	natural	960	120	m
1022518	20x2,0 120m	120	20	2	6	natural	840	120	m
1022689	25x2,3 50m	50	25	2,3	6	natural	450	50	m
1001220	32x2,9 50m	50	32	2,9	6	natural	550	50	m
1008449	32x2,9 100m	100	32	2,9	6	natural	700	100	m
1008979	40x3,7 50m	50	40	3,7	6	natural	350	50	m
1008975	40x3,7 100m	100	40	3,7	6	natural	700	100	m
1008980	50x4,6 50m	50	50	4,6	6	natural	350	50	m
1008981	63X5,8 50m	50	63	5,8	6	natural		50	m
1008982	75x6,8 50m	50	75	6,9	6	natural	50	50	m

Uponor Radi Pipe

Uponor Radi Pipe natural PN6 S

- Operating pressure 6 bar
- 6 m bars

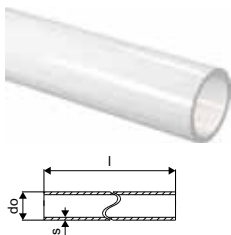

Item no.	Dimension	L m	do mm	s mm	p bar	colour	Qty 2	Qty 1	UOM
1008939	40x3,7 6m	6	40	3,7	6	natural	846	6	m
1008940	50x4,6 6m	6	50	4,6	6	natural	30	6	m
1008941	63X5,8 6m	6	63	5,8	6	natural	18	6	m
1008864	75x6,8 6m	6	75	6,8	6	natural	6	6	m
1008874	90x8,2 6m	6	90	8,2	6	natural	6	6	m
1008879	110x10,0 6m	6	110	10,0	6	natural	6	6	m

Uponor Radi Pipe in conduit

Specification

Pipes manufactured from peroxide cross-linked polyethylene (PE-Xa) acc. EN ISO 15875

EVOH (ethylene vinyl alcohol) layer for oxygen diffusion resistance as per DIN 4726

Application class 5 - high temperature radiators

Fire classification E according to DIN EN 13501-1.

Conduits manufactured from high density polyethylene

Application

- Heating: The permanent operating temperature ranges up to 90°C. The short-term malfunction temperature is 100°C for a period of 100 hours in the operating life time.
- Leakage free installations with possibility to exchange pipes in case of damage

Uponor Radi Pipe natural in conduit red

- Operating pressure 6 bar
- Coils

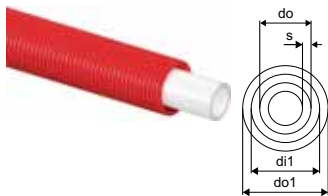

Item no.	Dimension	L m	di1 mm	do mm	do1 mm	s mm	p bar	colour	Qty 2	Qty 1	UOM
1008388	16x2,0 25/20 50m	50	20	16	25	2	6	red	550	50	m
1042149	20x2,0 28/23 50m	50	23	20	28	2	6	red	400	50	m

Uponor Teck

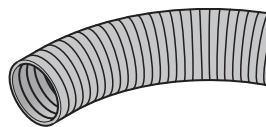

Uponor Teck are conduit pipes designed to protect the interior of flexible multilayer pipes used for tap water and heating/cooling application.

Your benefits

- Ensures safe and secure water supply
- Certified quality
- Protects inner pipe
- Colour coding for hot and cold water



Specification

- Corrugated, made of high density polyethylene (HDPE)
- Fire classification E according to EN 13501-1
- Supplied in coils.
- Accessories for conduit fixing, sealing and jointing

Application

- Used for pipe in pipe (PIP) installations to reduce the risk for water damages with possibility to exchange flexible media pipes

Uponor Teck conduit black

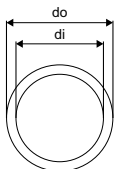

Item no.	Dimension	L m	di mm	do mm	colour	Qty 2	Qty 1	UOM
1023127*	54/48	25m	25	48	54 black	600	25	m

Uponor Teck conduit

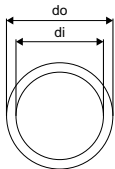

Item no.	Dimension	L m	di mm	do mm	colour	Qty 2	Qty 1	UOM
1012858	25/20	red 50m	50	20	25 red	2500	50	m
1012862	28/23	red 50m	50	23	28 red	2000	50	m
1012866	35/29	red 50m	50	29	35 red	1400	50	m

Uponor Teck

Uponor Teck conduit

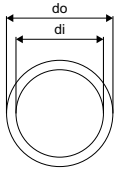

Item no.	Dimension	L m	di mm	do mm	colour	Qty 2	Qty 1	UOM
1012859	25/20 blue 50m	50	20	25	blue	2500	50	m
1012863	28/23 blue 50m	50	23	28	blue	2000	50	m
1012867	35/29 blue 50m	50	29	35	blue	1400	50	m

Uponor Teck conduit

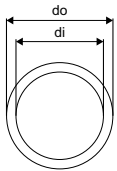

Item no.	Dimension	L m	di mm	do mm	colour	Qty 2	Qty 1	UOM
1012860	25/20 black 50m	50	20	25	black	2500	50	m
1012864	28/23 black 50m	50	23	28	black	2000	50	m
1012869	35/29 black 50m	50	29	35	black	1400	50	m
1012872	43/36 black 25m	25	36	43	black	600	25	m

Uponor Flex

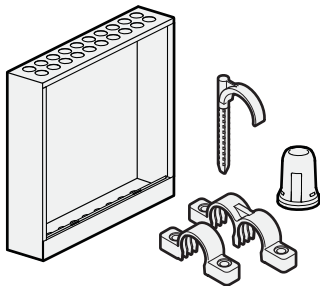

Uponor Flex brings together all accessories, such as cabinets, sleeves, pipe clips, pipe bend supports and tap connections, which are used when installing systems with Uponor flexible pipes.

Your benefits

- Wide range of accessories
- Easy to use
- Fast installation



Uponor Multi bend support plastic

- Impact resistant plastic
- Bend support 90°

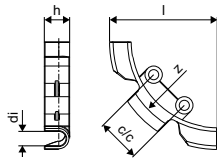

Item no.	Dimension	l mm	di mm	c/c mm	z mm	h mm	r mm	Qty 2	Qty 1	UOM
1063781	12	73	10	30	65	18	65	500	50	pce

Uponor Multi bend support plastic

- Impact resistant plastic
- Bend support 90°

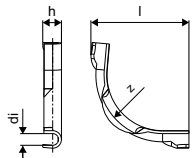

Item no.	Dimension	l mm	di mm	z mm	h mm	r mm	Qty 2	Qty 1	UOM
1020224	16	100	15	70	22	70	500	50	pce
1000118	18	115	16,5	90	25	90	250	50	pce
1001229	20	150	22	115	31	115	2300	50	pce
1001230	28	175	27	145	40	145	900	50	pce

Uponor Multi bend support string plastic

- Supporting element for adjustable bendings
- Plastic

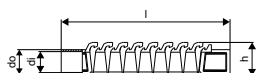

Item no.	Dimension	l mm	di mm	do mm	h mm	r mm	Qty 2	Qty 1	UOM
1034554	20	174	21,5	25,5	34	75	200	20	pce
1034555	21-25	280	28,4	33,8	44	120	100	20	pce

Uponor Flex

Uponor Multi bend support galv steel

- Galvanized steel
- Bend support 90°



Item no.	Dimension	l mm	di mm	z mm	h mm	r mm	colour	Qty 2	Qty 1	UOM
1009006	25	170	25,5	134	22	134	galv steel	2340	10	pce
1001231	34	210	32	137	28	137	galv steel	1400	2	pce

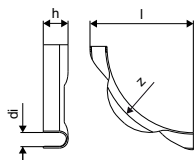

Uponor Teck single plugged hook

- for fixing pipes up to a max. outside diameter of 32 mm to the raw concrete ceiling
- Made of plastic
- Colour: blue
- Drill hole 8 mm

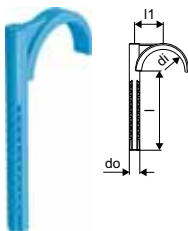

Item no.	Dimension	l mm	l1 mm	di mm	do mm	Qty 2	Qty 1	UOM
1013137	32 60mm	60	20	32	8	1000	50	pce
1013138	32 80mm	80	20	32	8	1000	50	pce

Uponor Teck double plugged hook

- for fixing pipes up to a max. outside diameter of 32 mm to the raw concrete ceiling
- Made of plastic
- Colour: blue
- Drill hole 8 mm

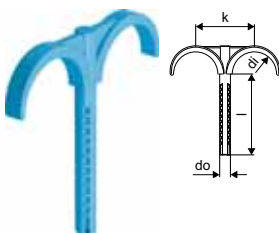

Item no.	Dimension	l mm	di mm	do mm	k mm	Qty 2	Qty 1	UOM
1013139	32 60mm	60	32	8	40	1000	50	pce
1013140	32 80mm	80	32	8	40	1000	50	pce

Uponor Flex

Uponor Smart Radi cover plate dividable

- Made of polypropylene white
- for Uponor Uni Pipe PLUS and MLC pipes 14 - 20 mm, to cover floor and/or wall penetration of the radiator connection pipe line
- Required inside micrometer (pipe middle - middle) between two Uponor MLC pipes for supply and return flow: 50 mm. The cascaded penetrations can be severed easily with a knife according to desired pipe dimension.
- The snap ring consists of two halves, which are pressed together with two push buttons by hand
- Fire classification B2 acc. to EN 13501-1.

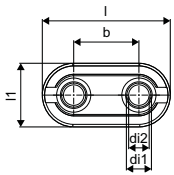

Item no.	Dimension	Qty 2	Qty 1	UOM
1011373	14-20 white double	500	50	pce

Uponor Smart Radi pipe protection

- Made of plastic, white, length 200 mm. Including stoppers for pipes up to 16 mm. Two in a set.

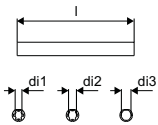

Item no.	Dimension	l	l1	l2	di	di1	di2	di3	do	Qty 2	Qty 1	UOM
1023176	16, l=200mm	200	20	3	12	12	14	16	23	50	1	set

Uponor Smart Radi bend support

- Made of white plastic.
- For radiator connections from the floor with PE-Xa and MLC pipes in dimension 16.
- Dividable, for conduit 25/20 mm.
- Min. c/c 40 mm, including 5 mm distance.

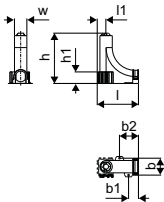

Item no.	Dimension	l	l1	b	b1	b2	h	h1	w	Qty 2	Qty 1	UOM
1009008	25/20mm	100	21	41	24	46	122	28	30	750	10	pce

Uponor Q&E

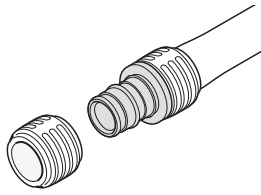

Uponor Q&E is a unique and innovative fittings system that uses the shrink-back effect of cross-linked polyethylene PE-Xa pipes for quick and easy installation. A wide range of fittings and accessories makes Q&E a

complete and secure system for cost-effective installation. Corrosion resistance makes it safe, secure and watertight.

Your benefits

- Elasticity of PE-Xa pipes for high safety
- Corrosion resistant
- Low pressure loss
- Ergonomic design of ring
- Easy identification of ring dimension



Specification

- Q&E fittings and rings for Uponor Pex pipes
- Metal fittings are made of high quality brass
- Plastic fittings are made of polyphenylsulphone
- Q&E rings must be ordered separately if not different mentioned

Application

if not different mentioned:

- Male and female threads acc.to EN 10226-1.

Uponor Q&E evolution ring white

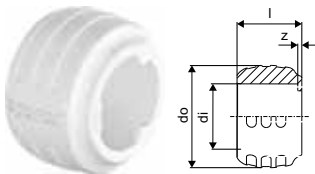

Item no.	Dimension	l mm	di mm	do mm	z mm	p bar	colour -	Qty 2	Qty 1	UOM
1057453	16	16	16,2	25,3	1	6+10	white	900	20	pce
1057454	20	20	20,2	29,2	1	6+10	white	520	20	pce
1057455	25	25	25,3	34,6	1	6+10	white	300	20	pce
1057456	32	32	32,4	41,8	1	6+10	white	150	10	pce

Uponor Q&E evolution ring red

- Conical inner shape
- With stop edge
- PE material

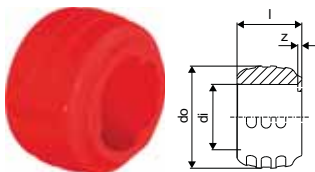

Item no.	Dimension	l mm	di mm	do mm	z mm	p bar	colour -	Qty 2	Qty 1	UOM
1058010	16	16	16,2	25,3	1	6+10	red	900	20	pce
1058011	20	20	20,2	29,2	1	6+10	red	520	20	pce
1058012	25	25	25,3	34,6	1	6+10	red	300	20	pce

Uponor Q&E evolution ring blue

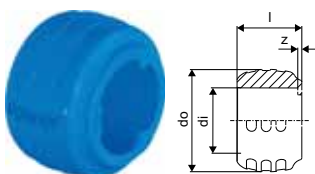

Item no.	Dimension	l mm	di mm	do mm	z mm	p bar	colour -	Qty 2	Qty 1	UOM
1058013	16	16	16,2	25,3	1	6+10	blue	900	20	pce
1058014	20	20	20,2	29,2	1	6+10	blue	520	20	pce
1058015	25	25	25,3	34,6	1	6+10	blue	300	20	pce

Uponor Q&E

Uponor Q&E ring with stop edge natural

- With stop edge
- Pex material

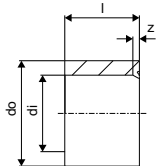

Item no.	Dimension	l mm	di mm	do mm	z mm	p mm bar	colour	Qty 2	Qty 1	UOM
1045464	40	41	40,8	50,2	3	6+10	natural	80	5	pce
1045489	50	50	51	63	4	6+10	natural	70	5	pce
1045490	63	63	64,3	75,7	4	6+10	natural	35	5	pce
1085087	75	76	76,3	88,3	4	6+10	natural	18	2	pce

Uponor Q&E manifold PPSU

- Main connection for Q&E 25 mm

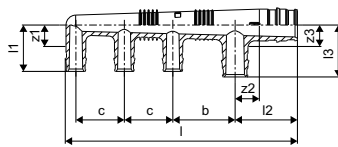

Item no.	Dimension	outlets	l	l1	l2	l3	z1	z2	z3	b	b1	p	Qty 2	Qty 1	UOM
1008718	25, 3X16 c/c45+35	3	133	34	45	34	16	18	16	45	35	6+10	15	1	pce
1008719	25 4X16 c/c45+2X35	4	168	34	45	34	16	18	16	45	35	6+10	15	1	pce

Uponor Q&E manifold male thread PPSU

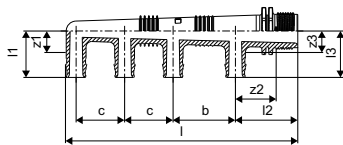

Item no.	Dimension	outlets	l	l1	l2	l3	z1	z2	z3	b	b1	p	Qty 2	Qty 1	UOM
1008714	G3/4"MT 3X16 c/c45+35mm	3	133	34	45	34	16	29	16	45	35	6+10	10	1	pce
1008715	G3/4"MT 4X16 c/c45+2X35mm	4	168	34	45	34	16	29	16	45	35	6+10	10	1	pce
1008716	G3/4"MT 1X20+2X16 c/c45+35mm	3	133	34	45	38	16	29	16	45	35	6+10	10	1	pce
1008717	G3/4"MT 1X20+3X16 c/c45+2X35mm	4	168	34	45	38	16	29	16	45	35	6+10	10	1	pce

Uponor Q&E adapter male thread PPSU

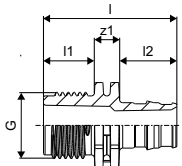

Item no.	Dimension	l	l1	l2	G	z1	p	Qty 2	Qty 1	UOM
1008661	16-G1/2"MT	42	16	18	1/2	8	6+10	100	5	pce
1008662	20-G1/2"MT	46	16	22	1/2	8	6+10	90	5	pce
1008663	20-G3/4"MT	48	18	22	3/4	8	6+10	70	5	pce
1008664	25-G3/4"MT	54	18	28	3/4	8	6+10	50	5	pce
1008665	25-G1"MT	58	23	28	1	8	6+10	40	5	pce

Uponor Q&E

Uponor Q&E adapter female thread PPSU

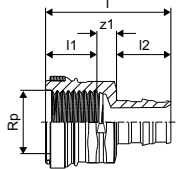

Item no.	Dimension	l	l1	l2	Rp	z1	p	Qty 2	Qty 1	UOM
		mm	mm	mm	inch	mm	bar			
1042329	16-Rp1/2"FT	42	17	18	1/2	7	6+10	80	5	pce
1042330	20-Rp1/2"FT	45	17	22	1/2	6	6+10	60	5	pce
1042331	20-Rp3/4"FT	47	18	22	3/4	7	6+10	50	5	pce
1042332	25-Rp3/4"FT	52	18	28	3/4	6	6+10	40	5	pce

Uponor Q&E elbow PPSU

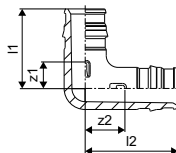

Item no.	Dimension	l1	l2	z1	z2	p	Qty 2	Qty 1	UOM
		mm	mm	mm	mm	bar			
1008679	16-16	27	32	9	13	6+10	100	5	pce
1008680	20-20	34	39	12	16	6+10	40	5	pce
1008681	25-25	42	47	14	19	6+10	25	5	pce
1001245	32-32	53	59	18	23	6+10	15	1	pce
1008683	40-40	65	74	21	29	6+10	10	1	pce
1042859	50-50	83	98	29	44	6+10	5	1	pce
1042858	63-63	100	112	33	44	6+10	3	1	pce
1085080	75-75	149	149	64	65	6+10	2	1	pce

Uponor Q&E elbow adapter male thread PPSU

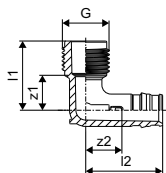

Item no.	Dimension	l1	l2	G	z1	z2	p	Qty 2	Qty 1	UOM
		mm	mm	inch	mm	mm	bar			
1008666	16-G1/2"MT	31	34	1/2	15	16	6+10	80	5	pce
1008667	20-G1/2"MT	31	38	1/2	15	16	6+10	60	5	pce
1008668	25-G3/4"MT	36	42	3/4	18	15	6+10	40	5	pce

Uponor Q&E elbow adapter female thread PPSU

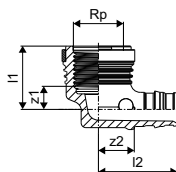

Item no.	Dimension	l1	l2	Rp	z1	z2	p	Qty 2	Qty 1	UOM
		mm	mm	inch	mm	mm	bar			
1042334	16-Rp1/2"FT	27	33	1/2	10	15	6+10	50	5	pce
1042335	20-Rp1/2"FT	27	38	1/2	9	16	6+10	50	5	pce
1042336	20-Rp3/4"FT	30	41	3/4	12	19	6+10	40	5	pce
1042337	25-Rp3/4"FT	32	47	3/4	14	19	6+10	35	5	pce

Uponor Q&E

Uponor Q&E coupling PPSU

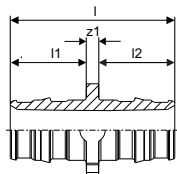

Item no.	Dimension	l mm	l1 mm	l2 mm	z1 mm	p bar	Qty 2	Qty 1	UOM
1008669	16-16	39	18	18	3	6+10	100	5	pce
1008932	20-20	47	22	22	3	6+10	80	5	pce
1008671	25-25	58	28	28	3	6+10	50	5	pce
1001235	32-32	73	35	35	3	6+10	20	1	pce
1008673	40-40	90	44	44	3	6+10	10	1	pce
1042866	50-50	113	54	54	5	6+10	10	1	pce
1042865	63-63	141	68	68	6	6+10	5	1	pce
1085084	75-75	179	86	86	7	6+10	10	1	pce

Uponor Q&E reducer PPSU

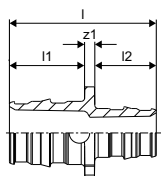

Item no.	Dimension	l mm	l1 mm	l2 mm	z1 mm	p bar	Qty 2	Qty 1	UOM
1008674	20-16	43	22	18	3	6+10	100	5	pce
1008675	25-16	49	28	18	3	6+10	40	5	pce
1008676	25-20	53	22	28	3	6+10	40	5	pce
1001240	32-25	66	28	35	3	6+10	20	1	pce
1008678	40-32	82	35	44	3	6+10	10	1	pce
1042879	50-32	94	54	35	5	6+10	10	1	pce
1042867	50-40	103	54	44	5	6+10	10	1	pce
1042878	63-40	117	68	44	6	6+10	5	1	pce
1042877	63-50	128	68	54	6	6+10	5	1	pce
1085086	75-50	147	86	54	6	6+10	10	1	pce
1085085	75-63	160	86	68	7	6+10	10	1	pce

Uponor Q&E tee PPSU

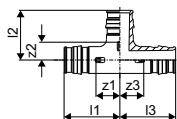

Item no.	Dimension	l1 mm	l2 mm	l3 mm	z1 mm	z2 mm	z3 mm	p bar	Qty 2	Qty 1	UOM
1008684	16-16-16	32	27	32	14	10	14	6+10	70	5	pce
1008685	20-20-20	39	34	39	17	12	17	6+10	35	5	pce
1008686	25-25-25	47	42	47	20	15	20	6+10	25	5	pce
1001250	32-32-32	59	53	59	24	18	24	6+10	10	1	pce
1008688	40-40-40	74	65	74	30	22	30	6+10	5	1	pce
1042861	50-50-50	92	83	92	38	29	38	6+10	3	1	pce
1042860	63-63-63	112	102	112	44	5	44	6+10	2	1	pce
1085081	75-75-75	156	123	156	70	37	70	6+10	2	1	pce

Uponor Q&E

Uponor Q&E tee reducer PPSU

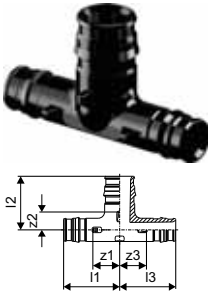

Item no.	Dimension	l1 mm	l2 mm	l3 mm	z1 mm	z2 mm	z3 mm	p bar	Qty 2	Qty 1	UOM
1008710	16-20-16	35	33	35	17	11	17	6+10	40	5	pce
1008700	20-16-16	36	29	32	14	11	14	6+10	40	5	pce
1008689	20-16-20	36	29	36	14	11	14	6+10	40	5	pce
1008697	20-20-16	36	34	32	14	12	14	6+10	40	5	pce
1008711	20-25-20	42	40	42	20	12	20	6+10	25	5	pce
1008702	25-16-16	41	32	32	14	14	14	6+10	25	5	pce
1008699	25-16-20	41	32	36	14	14	14	6+10	25	5	pce
1008690	25-16-25	41	32	41	14	14	14	6+10	25	5	pce
1008701	25-20-16	44	37	35	17	15	17	6+10	25	5	pce
1008703	25-20-20	44	37	39	17	15	17	6+10	25	5	pce
1008691	25-20-25	44	37	44	17	15	17	6+10	25	5	pce
1001420	25-25-20	47	42	42	20	15	20	6+10	25	5	pce
1008712	25-32-25	52	50	52	24	15	24	6+10	15	1	pce
1001422	32-20-25	52	40	44	17	18	17	6+10	15	1	pce
1001424	32-20-32	52	40	52	17	18	17	6+10	15	1	pce
1008704	32-25-20	55	45	42	20	18	20	6+10	15	1	pce
1001426	32-25-25	55	45	47	20	18	20	6+10	15	1	pce
1001428	32-25-32	55	45	55	20	18	20	6+10	15	1	pce
1008713	32-40-32	65	61	65	30	18	30	6+10	10	1	pce
1008707	40-20-32	60	44	52	17	22	17	6+10	5	1	pce
1008694	40-20-40	60	44	60	17	22	17	6+10	5	1	pce
1008708	40-25-32	63	49	55	20	22	20	6+10	5	1	pce
1008695	40-25-40	63	49	63	20	22	20	6+10	5	1	pce
1008709	40-32-32	68	57	59	24	22	24	6+10	5	1	pce
1008696	40-32-40	68	57	68	24	22	24	6+10	5	1	pce
1042876	50-25-40	92	57	82	38	29	39	6+10	4	1	pce
1042864	50-25-50	92	57	92	38	29	38	6+10	4	1	pce
1042863	50-32-50	92	64	92	38	29	38	6+10	4	1	pce
1042862	50-40-40	92	73	82	38	29	39	6+10	4	1	pce
1042875	50-40-50	92	73	92	38	29	38	6+10	4	1	pce
1042871	63-25-50	112	62	99	44	35	45	6+10	2	1	pce
1042873	63-25-63	112	60	112	44	33	44	6+10	2	1	pce
1042870	63-32-63	112	70	112	44	35	44	6+10	2	1	pce
1042869	63-40-40	112	78	99	44	35	55	6+10	2	1	pce
1042872	63-40-63	112	78	112	44	35	44	6+10	2	1	pce
1042868	63-50-50	112	89	99	44	35	45	6+10	2	1	pce
1042874	63-50-63	112	89	112	44	35	44	6+10	2	1	pce
1085083	75-25-75	118	67	118	32	39	32	6+10	4	1	pce
1085082	75-40-75	118	83	118	32	83	32	6+10	4	1	pce

Uponor Q&E

Uponor Q&E tee adapter female thread PPSU



Item no.	Dimension	l1	l2	l3	Rp	z1	z2	z3	p	Qty 2	Qty 1	UOM
		mm	mm	mm	inch	mm	mm	mm	bar			
1042338	16-Rp1/2"FT-16	33	28	33	1/2	15	10	15	6+10	50	5	pce
1042339	20-Rp1/2"FT-20	38	27	38	1/2	16	10	16	6+10	40	5	pce
1042340	25-Rp1/2"FT-25	43	30	43	1/2	15	13	15	6+10	25	5	pce
1042341	25-Rp3/4"FT-25	47	31	47	3/4	19	13	19	6+10	25	5	pce

Uponor Q&E adapter swivel nut PPSU

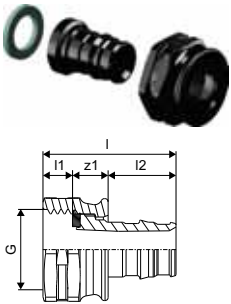

Item no.	Dimension	l	l1	l2	G	z1	p	Qty 2	Qty 1	UOM
		mm	mm	mm	inch	mm	bar			
1038021	16-G1/2"SN	35	8	18	1/2	9	6+10	50	1	pce
1038022	20-G1/2"SN	47	9	22	1/2	16	6+10	40	1	pce
1038023	20-G3/4"SN	39	8	22	3/4	9	6+10	30	1	pce
1038024	25-G3/4"SN	53	8	28	3/4	17	6+10	25	1	pce
1038025	25-G1"SN	46	10	27	1	9	6+10	25	1	pce

Uponor Q&E elbow adapter swivel nut PPSU

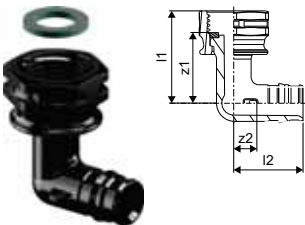

Item no.	Dimension	l1	l2	G	z1	z2	p	Qty 2	Qty 1	UOM
		mm	mm	inch	mm	mm	bar			
1038037	16-G1/2"SN	36	27	1/2	28	9	6+10	40	1	pce
1038038	20-G1/2"SN	38	31	1/2	30	10	6+10	35	1	pce
1038039	20-G3/4"SN	38	34	3/4	29	12	6+10	25	1	pce

Uponor Q&E manifold male female thread PL

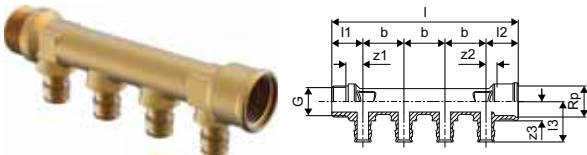

Item no.	Dimension	outlets	l	l1	l2	l3	G	Rp	z1	z2	b	p	Qty 2	Qty 1	UOM
		-	mm	mm	mm	mm	inch	inch	mm	mm	mm	bar			
1023027	3/4"MT/FT 2X16 c/c35mm	2	89	27	28	35	3/4	3/4	15	9	35	6+10	20	1	pce
1023028	3/4"MT/FT 3X16 c/c35mm	3	124	27	28	35	3/4	3/4	15	9	35	6+10	15	1	pce
1023029	3/4"MT/FT 4X16 c/c35mm	4	159	27	28	35	3/4	3/4	15	9	35	6+10	10	1	pce

Uponor Q&E

Uponor Q&E manifold male female thread PL

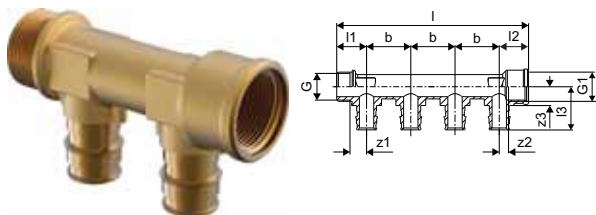

Item no.	Dimension	outlets	l	l1	l2	l3	G	G1	z1	z2	b	Qty 2	Qty 1	UOM
-	-	-	mm	mm	mm	mm	inch	inch	mm	mm	mm			
1047925*	3/4"MT/FT 3X20 c/c40mm	3	134	27	27	39	3/4	3/4	15	12	40	15	1	pce
1047926	3/4"MT/FT 4X20 c/c40mm	4	174	27	27	39	3/4	3/4	15	12	40	10	1	pce

Uponor Q&E manifold male female thread DR

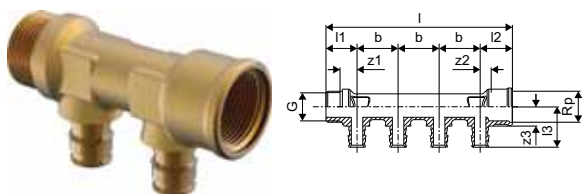

Item no.	Dimension	outlets	l	l1	l2	l3	G	Rp	z1	z2	z3	b	p	Qty 2	Qty 1	UOM
-	-	-	mm	mm	mm	mm	inch	inch	mm	mm	mm	mm	bar			
1063756	3/4"MT/FT 2X16 c/c35mm	2	89	27	28	35	3/4	3/4	15	9	17	35	6+10	20	1	pce
1063757	3/4"MT/FT 3X16 c/c35mm	3	124	27	28	35	3/4	3/4	15	9	17	35	6+10	15	1	pce
1063758	3/4"MT/FT 4X16 c/c35mm	4	159	27	28	35	3/4	3/4	15	9	17	35	6+10	10	1	pce

Uponor Q&E manifold male female, valve PL SH



Item no.	Dimension	outlets	d	IG	p	Qty 2	Qty 1	UOM
-	-	-	mm	inch	bar			
1048520	1"MT/FT 2X16 c/c38mm	2	16	G 1	6+10	32	1	pce
1048521	1"MT/FT 3X16 c/c38mm	3	16	G 1	6+10	32	1	pce
1048522	1"MT/FT 4X16 c/c38mm	4	16	G 1	6+10	24	1	pce

Uponor Uni-C bracket SH

- Manifolds and accessories



Item no.	Dimension	Qty 2	Qty 1	UOM
1045451*	3/4" 1"	25	1	set

Uponor Q&E

Uponor Q&E adapter male thread PL

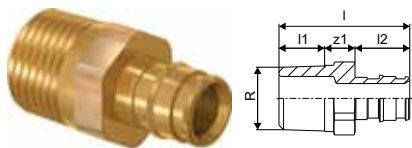

Item no.	Dimension	l mm	l1 mm	l2 mm	R inch	z1 mm	p bar	Qty 2	Qty 1	UOM
1023003	16-R1/2"MT	43	15	18	1/2	10	6+10	100	5	pce
1023004	16-R3/4"MT	46	17	18	3/4	11	6+10	80	5	pce
1023005	20-R1/2"MT	47	15	22	1/2	10	6+10	100	5	pce
1023006	20-R3/4"MT	50	17	22	3/4	11	6+10	70	5	pce
1023007	25-R3/4"MT	55	17	27	1/2	11	6+10	70	5	pce
1023008	25-R1"MT	58	20	27	3/4	11	6+10	40	5	pce
1047191	32-R1"MT	65	21	34	3/4	10	6+10	10	1	pce

Uponor Q&E adapter male thread PL/DR

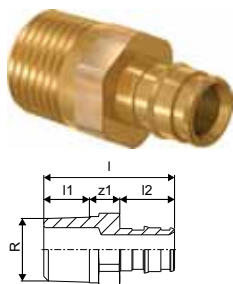

Item no.	Dimension	l mm	l1 mm	l2 mm	R inch	z1 mm	p bar	Qty 2	Qty 1	UOM
1085077	40-R1 1/4"MT	73	19	42	1 1/4	12	6+10	16	1	pce
1085076	50-R1 1/2"MT	89	20	52	1 1/2	17	6+10	8	1	pce
1085075	63-R2"MT	100	24	65	2	11	6+10	6	1	pce
1085074	75-R2 1/2"MT	126	27	86	2 1/2	13	6+10	6	1	pce

Uponor Q&E adapter male thread PL

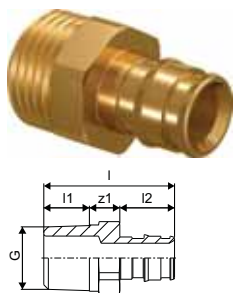

Item no.	Dimension	l mm	l1 mm	l2 mm	G inch	z1 mm	p bar	Qty 2	Qty 1	UOM
1047862	25-G3/4"MT	48	11	27	3/4	10	6+10	40	5	pce
1047863	25-G1"MT	49	11	27	1	11	6+10	40	5	pce
1047864	50-G1 1/2"MT	82	17	52	1 1/2	13	6+10	8	1	pce

Uponor Q&E adapter male thread PL W

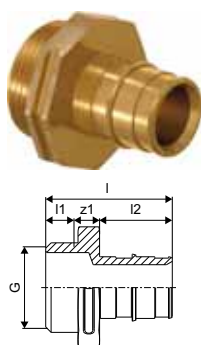

Item no.	Dimension	l mm	l1 mm	l2 mm	G inch	z1 mm	p bar	Qty 2	Qty 1	UOM
1008730	32-G1"MT	56	10	34	1	12	6+10	20	1	pce
1022290	40-G1"MT	64	11	42	1	11	6+10	16	1	pce
1008732	40-G1 1/4"MT	68	14	42	1 1/4	12	6+10	8	1	pce
1008866	50-G1 1/4"MT	78	14	52	1 1/4	12	6+10	8	1	pce
1008867	63-G2"MT	95	17	65	2	13	6+10	6	1	pce

Uponor Q&E

Uponor Q&E adapter male thread DR

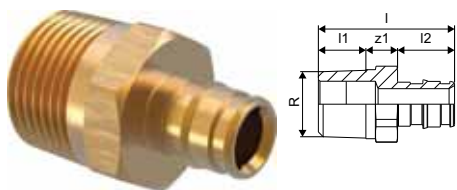

Item no.	Dimension	l	l1	l2	R	z1	p	Qty 2	Qty 1	UOM
		mm	mm	mm	inch	mm	bar			
1063732	16-R1/2"MT	43	11	18	1/2	14	6+10	100	5	pce
1063733	16-R3/4"MT	46	11	18	3/4	16	6+10	80	5	pce
1063734	20-R1/2"MT	47	11	22	1/2	14	6+10	100	5	pce
1063735	20-R3/4"MT	50	13	22	3/4	15	6+10	70	5	pce
1063736	25-R3/4"MT	55	13	22	3/4	20	6+10	70	5	pce
1063737	25-R1"MT	58	15	27	1	16	6+10	40	5	pce
1063806	32-R1"MT	65	15	34	1	17	6+10	20	1	pce

Uponor Q&E adapter male thread DR W

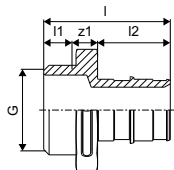

Item no.	Dimension	l	l1	l2	G	z1	p	Qty 2	Qty 1	UOM
		mm	mm	mm	inch	mm	bar			
1063810	25-G1"MT	47	11	27	1	9	6+10	35	5	pce
1063724	32-G1"MT	56	10	34	1	12	6+10	10	1	pce
1063725	40-G1 1/4"MT	68	14	42	1 1/4	12	6+10	16	1	pce
1063727	50-G1 1/4"MT	78	14	52	1 1/4	12	6+10	8	1	pce
1063728	63-G2"MT	95	17	65	2	13	6+10	6	1	pce

Uponor Q&E adapter female thread PL

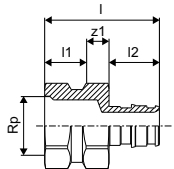

Item no.	Dimension	l	l1	l2	Rp	z1	p	Qty 2	Qty 1	UOM
		mm	mm	mm	inch	mm	bar			
1023009	16-Rp1/2"FT	41	15	18	1/2	8	6+10	60	5	pce
1023010	20-Rp1/2"FT	44	15	22	1/2	7	6+10	60	5	pce
1023011	20-Rp3/4"FT	46	18	22	3/4	6	6+10	40	5	pce
1023012	25-Rp3/4"FT	51	18	27	3/4	6	6+10	40	5	pce
1023013	25-Rp1"FT	55	22	27	1	6	6+10	35	5	pce

Uponor Q&E

Uponor Q&E adapter female thread PL/DR

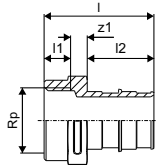

Item no.	Dimension	l	l1	l2	Rp	z1	p	Qty 2	Qty 1	UOM
		mm	mm	mm	inch	mm	bar			
1085078	50-RP1 1/2"FT	92	21	52	1 1/2	19	6+10	8	1	pce

Uponor Q&E adapter female thread PL

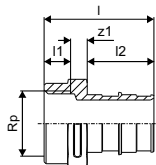

Item no.	Dimension	l	l1	l2	G	z1	p	Qty 2	Qty 1	UOM
		mm	mm	mm	inch	mm	bar			
1047866	32-G1"FT	56	13	34	1	9	6+10	20	1	pce
1047867	40-G1 1/4"FT	68	16	42	1 1/4	10	6+10	20	1	pce

Uponor Q&E adapter female thread DR

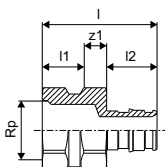

Item no.	Dimension	l	l1	l2	Rp	z1	p	Qty 2	Qty 1	UOM
		mm	mm	mm	inch	mm	bar			
1063738	16-Rp1/2"FT	41	15	18	1/2	8	6+10	60	5	pce
1063739	20-Rp1/2"FT	44	15	22	1/2	7	6+10	60	5	pce
1063740	20-Rp3/4"FT	46	18	22	3/4	6	6+10	40	5	pce

Uponor Q&E elbow PL

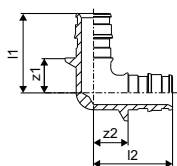

Item no.	Dimension	l1	l2	z1	z2	p	Qty 2	Qty 1	UOM
		mm	mm	mm	mm	bar			
1047199*	25-25	48	39	12	21	6+10	25	5	pce

Uponor Q&E

Uponor Q&E elbow adapter male thread PL

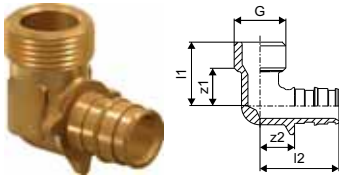

Item no.	Dimension	l1 mm	l2 mm	G inch	z1 mm	z2 mm	p bar	Qty 2	Qty 1	UOM
1023019	16-G1/2"MT	26	32	1/2	16	14	6+10	80	5	pce
1023020	20-G1/2"MT	29	33	1/2	17	21	6+10	50	5	pce
1023021	20-G3/4"MT	29	36	3/4	18	14	6+10	40	5	pce
1023022	25-G3/4"MT	29	41	3/4	20	14	6+10	40	5	pce
1047877	32-G1"MT	49	60	1	26	26	6+10	20	1	pce
1047878	40-G1 1/4"MT	61	74	1 1/4	46	32	6+10	10	1	pce

Uponor Q&E elbow adapter male thread DR



Item no.	Dimension	l1 mm	l2 mm	G inch	z1 mm	z2 mm	p bar	Qty 2	Qty 1	UOM
1063748	16-G1/2"MT	26	32	1/2	16	14	6+10	80	5	pce
1063750	20-G3/4"MT	29	36	3/4	18	14	6+10	40	5	pce
1063751	25-G3/4"MT	29	41	3/4	20	14	6+10	40	5	pce

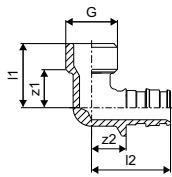

Uponor Q&E elbow adapter female thread PL



Item no.	Dimension	l1 mm	l2 mm	G inch	z1 mm	z2 mm	p bar	Qty 2	Qty 1	UOM
1023023	16-G1/2"FT	25	32	1/2	11	14	6+10	70	5	pce
1023024	20-G1/2"FT	25	36	1/2	11	14	6+10	50	5	pce
1023025	20-G3/4"FT	26	39	3/4	10	17	6+10	30	5	pce
1023026	25-G3/4"FT	26	44	3/4	10	17	6+10	35	5	pce

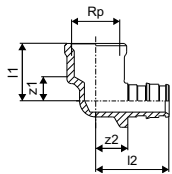

Uponor Q&E

Uponor Q&E elbow adapter female thread DR

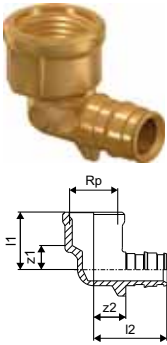

Item no.	Dimension	l1 mm	l2 mm	G inch	z1 mm	z2 mm	p bar	Qty 2	Qty 1	UOM
1063752	16-G1/2"FT	25	32	1/2	11	14	6+10	70	5	pce
1063753	20-G1/2"FT	25	36	1/2	11	14	6+10	50	5	pce
1063754	20-G3/4"FT	26	39	3/4	10	17	6+10	30	5	pce
1063755	25-G3/4"FT	26	44	3/4	10	17	6+10	35	5	pce

Uponor Q&E tee adapter female thread PL

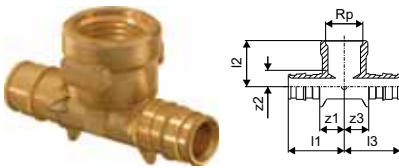

Item no.	Dimension	l1 mm	l2 mm	l3 mm	Rp1 inch	z1 mm	z2 mm	z3 mm	p bar	Qty 2	Qty 1	UOM
1047885	16-Rp1/2"FT-16	32	26	32	1/2	14	9	14	6+10	50	5	pce
1047886	20-Rp1/2"FT-20	36	28	36	1/2	14	11	14	6+10	30	5	pce
1047888	25-Rp3/4"FT-25	44	34	44	3/4	17	16	17	6+10	20	5	pce
1047201	32-Rp1"FT-32	59	49	59	1	25	28	25	6+10	10	1	pce

Uponor Q&E adapter swivel nut PL

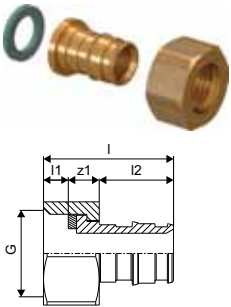

Item no.	Dimension	l mm	l1 mm	l2 mm	G inch	z1 mm	p bar	Qty 2	Qty 1	UOM
1023014	16-G1/2"SN	32	6	18	1/2	8	6+10	100	5	pce
1023015	20-G1/2"SN	42	8	22	1/2	13	6+10	60	5	pce
1023016	20-G3/4"SN	36	7	22	3/4	8	6+10	50	5	pce
1023017	25-G3/4"SN	49	7	27	3/4	15	6+10	45	5	pce
1023018	25-G1"SN	44	10	27	1	7	6+10	40	5	pce

Uponor Q&E adapter swivel nut DR

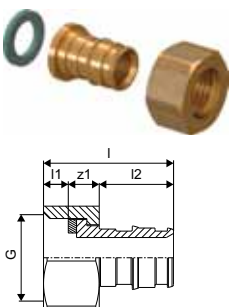

Item no.	Dimension	l mm	l1 mm	l2 mm	G inch	z1 mm	p bar	Qty 2	Qty 1	UOM
1063743	16-G1/2"SN	32	6	18	1/2	8	6+10	100	5	pce
1063744	20-G1/2"SN	42	8	22	1/2	12	6+10	60	5	pce
1063745	20-G3/4"SN	36	7	22	3/4	7	6+10	50	5	pce
1063746	25-G3/4"SN	49	7	27	3/4	15	6+10	45	5	pce

Uponor Q&E

Uponor Q&E elbow adapter swivel nut PL



Item no.	Dimension	l1 mm	l2 mm	G inch	z1 mm	z2 mm	p bar	Qty 2	Qty 1	UOM
1047879	16-G1/2"SN	35	32	1/2	28	14	6+10	70	5	pce
1047880	20-G1/2"SN	37	33	1/2	29	11	6+10	50	5	pce
1047881	20-G3/4"SN	39	36	3/4	32	14	6+10	35	5	pce
1047882	25-G3/4"SN	39	41	3/4	32	14	6+10	35	5	pce

Uponor Q&E adapter DR S-Press

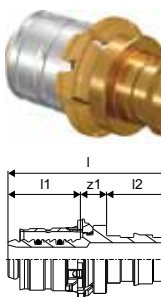

Item no.	Dimension	l mm	l1 mm	l2 mm	z1 mm	Qty 2	Qty 1	UOM
1062845	16-Q&E16	47	22	18	8	20	1	pce
1062846	20-Q&E20	52	23	22	8	10	1	pce
1062861	25-Q&E25	65	31	27	8	10	1	pce

Uponor Q&E adapter for soldering PL

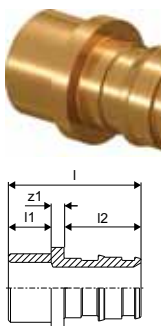

Item no.	Dimension	l mm	l1 mm	l2 mm	z1 mm	p bar	Qty 2	Qty 1	UOM
1047938	16-12CU	31	10	18	3	6+10	100	5	pce
1023040	16-15CU	34	13	18	3	6+10	100	5	pce
1023041	20-15CU	38	13	22	3	6+10	100	5	pce
1047940	20-18CU	38	13	22	3	6+10	80	5	pce
1047941	20-22CU	38	13	22	3	6+10	80	5	pce
1023042	25-22CU	43	13	27	3	6+10	40	5	pce

Uponor Q&E adapter DR

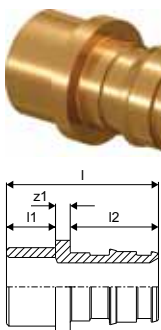

Item no.	Dimension	l mm	l1 mm	l2 mm	z1 mm	p bar	Qty 2	Qty 1	UOM
1008734	16-15CU l=16mm	36	15	18	3	6+10	100	5	pce
1008736	20-22CU l=20mm	45	20	22	3	6+10	100	5	pce

Uponor Q&E

Uponor Q&E stop end

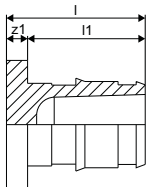

Item no.	Dimension	l mm	l1 mm	z1 mm	Qty 2	Qty 1	UOM
1084671	16	23	20	4	200	20	pce

Uponor Q&E valve concealed PL



Item no.	Dimension	d mm	p bar	l mm	l1 mm	z mm	z1 mm	Qty 2	Qty 1	UOM
1038419	16-16	16	6+10	38,6	28,0	20,6	10,0	10	1	pce
1038420	20-20	20	6+10	39,0	34,1	17,0	12,1	10	1	pce
1038421	25-25	25	6+10	44,8	40,5	17,8	13,5	10	1	pce

Uponor Flex con. valve, long handle

- Chrome plated lever and cover rosette.
- For Concealed valves.

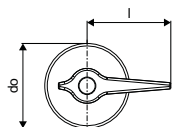

Item no.	l mm	do mm	Qty 2	Qty 1	UOM
1023161	67	67,8	10	10	pce

Uponor Flex con valve, public handle

- Chrome plated lever and cover rosette.
- For Concealed valves.

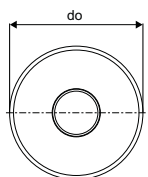

Item no.	do mm	Qty 2	Qty 1	UOM
1023162	67,8	10	1	pce

Uponor Q&E

Uponor Flex con valve, wheel handle

- For Concealed valves.



Item no.	Qty 2	Qty 1	UOM
1038462	10	1	pce

Uponor Flex con valve handle extension

- For Concealed valves.



Item no.	Qty 2	Qty 1	UOM
1023163	520	10	pce

Uponor Q&E

Uponor Smart Aqua

Specification

- Elbows for tap connection and
- Q&E rings must be ordered separately if not different mentioned

Application

- For tap water installations

if not different mentioned:

- Male and female threads acc.to EN 10226-1.

Uponor Smart Aqua U-tap elbow Q&E

- U elbow for loop installation

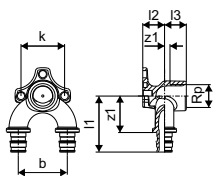

Item no.	Dimension	l1	l2	l3	Rp	z1	z2	b	k	Qty 2	Qty 1	UOM
		mm	mm	mm	inch	mm	mm	mm	mm			
1059820*	16-Rp1/2"FT-16	52	20	20	1/2	34	5	45	40	5	1	pce
1059821*	20-Rp1/2"FT-20	56	20	20	1/2	35	5	45	40	5	1	pce

Uponor Smart Aqua tap elbow Q&E PL

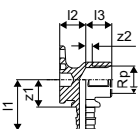

Item no.	Dimension	l1	l2	l3	Rp	z1	z2	p	Qty 2	Qty 1	UOM
		mm	mm	mm	inch	mm	mm	bar			
1059822	16-Rp1/2"FT	39	20	20	1/2	21	5	6+10	40	5	pce
1059823	20-Rp1/2"FT	40	20	20	1/2	18	5	6+10	40	5	pce

Uponor Smart Aqua tap elbow Q&E DR M

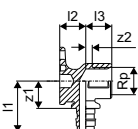

Item no.	Dimension	l1	l2	l3	Rp	z1	z2	p	Qty 2	Qty 1	UOM
		mm	mm	mm	inch	mm	mm	bar			
1063871	16-1/2"	39	20	20	1/2	21	5	6+10	40	5	pce

Uponor Q&E

Uponor Smart Aqua mounting angle

- Made of galvanized steel.
- For the installation of Uponor Smart Aqua tap elbows
- Positioning of the connections in the given raster
- Plastic pins and loss protected screws M6x12 acc. DIN 965 included
- With holes and slots for easy attachment

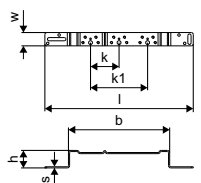

Item no.	Dimension	l mm	s mm	b mm	h mm	k mm	k1 mm	w mm	Qty 2	Qty 1	UOM
1057841	80mm	320	3	196	46	80		35	5	1	pce
1057839	100mm	340	3	216	46	100		35	5	1	pce
1057842	75/150mm	390	3	266	46	75	150	35	5	1	pce

Uponor Smart Aqua tap elbow mount. plate

- Made of galvanized steel.
- For the installation of Uponor Smart Aqua tap elbows
- Positioning of the connections in the given raster
- Plastic pins and loss protected screws M6x12 acc. DIN 965 included
- With holes and slots for easy attachment

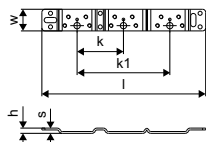
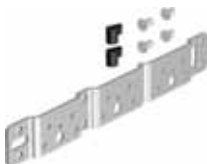

Item no.	Dimension	l mm	s mm	h mm	k mm	k1 mm	w mm	Qty 2	Qty 1	UOM
1057840	75/150mm	265	3,0	9	75	150	35	5	1	pce

Uponor Smart Aqua single mounting angle

- Made of galvanized steel.
- For the installation of Uponor Smart Aqua tap elbows.
- Positioning of the connections in the given raster.
- Screws M6x12 acc. DIN 965 included. With holes and slots for easy attachment

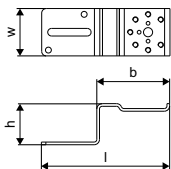
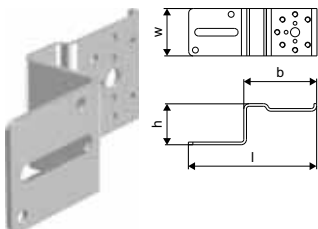

Item no.	l mm	b mm	h mm	Qty 2	Qty 1	UOM
1057843	144	82	46	5	1	pce

Uponor Q&E

Uponor Smart Aqua mounting rack

- Made of galvanized steel.
- For the installation of Uponor Smart Aqua tap elbows.
- Positioning of the connections in the given raster.
- Screws M6x12 acc. DIN 965 included. With holes and slots for easy attachment

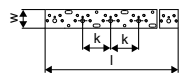

Item no.	Dimension	l mm	k mm	Qty 2	Qty 1	UOM
1057844	2m	2000	75	10	1	pce

Uponor Smart Aqua mounting rack bending tool

- For bending the 2 meter long mounting track.



Item no.	Dimension	Qty 2	Qty 1	UOM
1015424	2m	100	1	pce

Uponor Smart Aqua sound protection U-tap

- for one Uponor Smart Aqua U-tap elbow
- Pin and screws M6 x 16 included
- Made of EPDM
- Sound protection acc. DIN 4109.



12.21

Item no.	l1 mm	l2 mm	z1 mm	k mm	Qty 2	Qty 1	UOM
1060367	26	21	6	45	8	1	pce

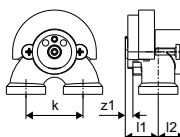

Uponor Smart Aqua set sound protec elbow

- set is suitable for two Uponor Smart Aqua tap elbows 16-Rp1/2"FT or 20-Rp1/2"FT
- Pins and screws M6 x 16 included
- Made of EPDM.
- Sound protection acc. DIN 4109.



12.21

Item no.	l1 mm	l2 mm	z1 mm	Qty 2	Qty 1	UOM
1057846*	30	18	6	384	1	set

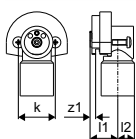

Uponor Q&E

Uponor Smart Aqua 10 pins+20 screws

- Pins and screws for mounting plates, angles and tracks.

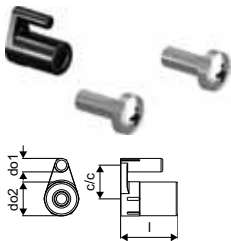

Item no.	l	d1	d2	c/c1	Qty 1	UOM
	mm	mm	mm	mm		
1057847	17	4	10	10	1	set

Uponor Smart Aqua tap elbow Q&E PPSU

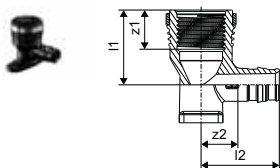

Item no.	Dimension	l1	l2	l3	Rp	z1	z2	k	p	Qty 2	Qty 1	UOM
		mm	mm	mm	inch	mm	mm	mm	mm			
1042342	16-Rp1/2" l=43mm	34	17	27	1/2	16	10	36	6+10	40	5	pce
1042343	20-Rp1/2" l=43mm	38	17	27	1/2	16	10	36	6+10	30	5	pce

Uponor Smart Aqua tap elbow long Q&E PPSU

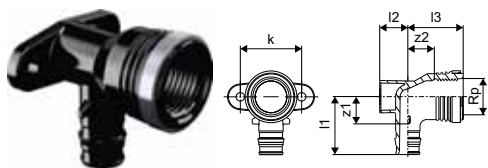

Item no.	Dimension	l1	l2	l3	Rp	z1	z2	k	p	Qty 2	Qty 1	UOM
		mm	mm	mm	inch	mm	mm	mm	mm			
1042344	16-Rp1/2" l=49mm	34	165	33	1/2	16	16	36	6+10	35	5	pce

Uponor Smart Aqua tap elbow Q&E PL

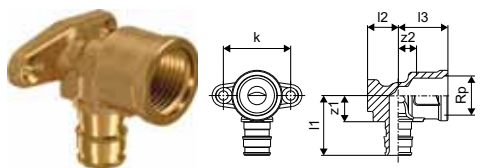

Item no.	Dimension	l1	l2	l3	Rp	z1	z2	k	p	Qty 2	Qty 1	UOM
		mm	mm	mm	inch	mm	mm	mm	mm			
1023034	16-Rp1/2"FT l=43mm	32	17	27	1/2	14	10	36	6+10	40	5	pce
1023035	20-Rp1/2"FT l=43mm	36	17	27	1/2	14	10	36	6+10	40	5	pce

Uponor Q&E

Uponor Smart Aqua term. box, empty Q&E ME

- For elbow 1042334

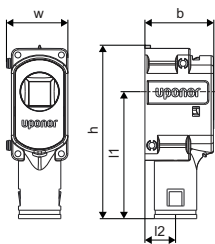

Item no.	Dimension	l1 mm	l2 mm	b mm	h mm	w mm	Qty 2	Qty 1	UOM
1048622	25/20	90	22	49	123	44	100	10	pce

Uponor Smart Aqua term. box, empty Q&E UP



Item no.	Dimension	Qty 2	Qty 1	UOM
1008845	25/20, 28/23	300	10	pce

Uponor Smart Aqua tap elbow term. box Q&E UP PL

- Fits to box 1008845

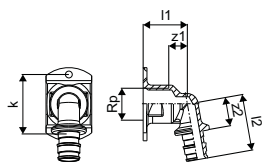

Item no.	Dimension	l1 mm	l2 mm	Rp inch	z1 mm	z2 mm	k mm	p mm bar	Qty 2	Qty 1	UOM
1047935	16-Rp1/2"FT	29	37	1/2	12	19	39	6+10	3840	40	pce

Uponor Smart Aqua tap elbow term. box Q&E UP DR

- Fits to box 1008845

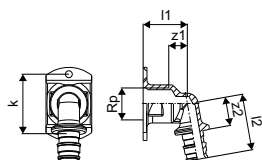

Item no.	Dimension	l1 mm	l2 mm	Rp inch	z1 mm	z2 mm	k mm	p mm bar	Qty 2	Qty 1	UOM
1063862	16-Rp1/2"	29	37	1/2	12	19	39	6+10	40	5	pce

Uponor Q&E

Uponor Smart Aqua term. box, empty Q&E SP

- For plastic tap elbow



Item no.	Dimension	Qty 2	Qty 1	UOM
1038470	34/28 42/36	200	10	pce

Uponor Smart Aqua tap elbow term. box Q&E SP PL

- Fits to box 1038470

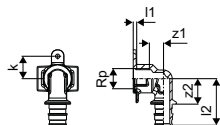

Item no.	Dimension	l1 mm	l2 mm	Rp inch	z1 mm	z2 mm	k mm	p bar	Qty 2	Qty 1	UOM
1047932	20-Rp1/2"FT	32	49	1/2	15	27	23	6+10	25	5	pce
1047933	25-Rp3/4"FT	32	54	3/4	15	27	23	6+10	20	5	pce

Uponor Smart Aqua tap elbow term. box Q&E SP DR

- Fits to box 1038470

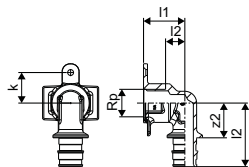

Item no.	Dimension	l1 mm	l2 mm	Rp inch	z1 mm	z2 mm	k mm	p bar	Qty 2	Qty 1	UOM
1063860	20-Rp1/2"FT	32	49	1/2	15	27	23	6+10	25	5	pce
1063861	25-Rp3/4"FT	32	54	3/4	15	27	23	6+10	20	5	pce

Uponor Smart Aqua tap elbow term. box Q&E A DR

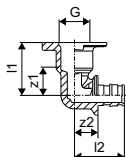

Item no.	Dimension	l1 mm	l2 mm	Rp inch	z1 mm	z2 mm	Qty 2	Qty 1	UOM
1029058	16-RP1/2"FT	36	34	1/2	19	16	40	5	pce

Uponor Q&E

Uponor Q&E valve U-shaped

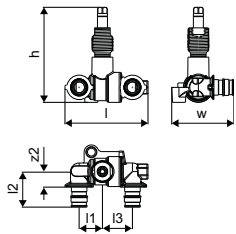

Item no.	Dimension	l mm	l1 mm	l2 mm	l3 mm	z2 mm	h mm	w mm	Qty 2	Qty 1	UOM
1088572	16	75	21	32	27	14	86	56	10	1	pce
1088571	20	75	21	36	27	14	86	60	10	1	pce
1088570	25	87	36	43	36	16	90	67	5	1	pce

Uponor Q&E handle straight

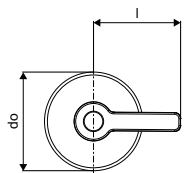

Item no.	l mm	do mm	Qty 2	Qty 1	UOM
1088566	60	67,8	10	1	set

Uponor Q&E handle cross

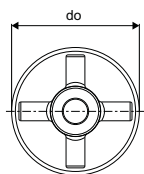

Item no.	do mm	Qty 2	Qty 1	UOM
1088569	67,8	10	1	set

Uponor Q&E

Uponor Smart Radi

Specification

- Fittings and accessories for radiator connection
- Q&E rings must be ordered separately if not different mentioned

Application

- Heating with high and with low tempertaure radiators

Uponor Smart Radi elbow adapter plated Q&E

- With coated copper pipe 15 x 1 mm.
- The connection of the coated copper pipe 15 x 1 mm to the radiator can be made with the Uponor clamp compression adapter Cu (Item-No. 1013830).

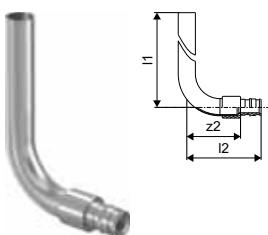

Item no.	Dimension	l1 mm	l2 mm	z2 mm	p bar	Qty 2	Qty 1	UOM
1023045	16-15CU l=300mm	300	65	47	6+10	40	2	pce
1023047	16-15CU l=1100mm	1100	65	47	6+10	20	2	pce
1023046	20-15CU l=300mm	300	69	47	6+10	30	2	pce

Uponor Smart Radi tee plated Q&E

- With coated copper pipe 15 x 1 mm.
- The connection of the coated copper pipe 15 x 1 mm to the radiator can be made with the Uponor clamp compression adapter Cu (Item-No. 1013830).

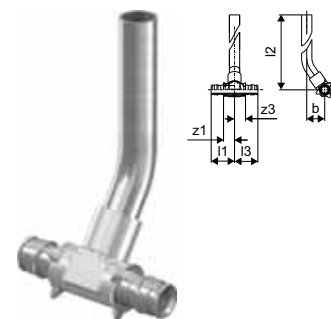

Item no.	Dimension	l1 mm	l2 mm	l3 mm	z1 mm	z3 mm	p bar	Qty 2	Qty 1	UOM
1023049	16-15CU-16 l=300mm	34	302	34	16	16	6+10	30	2	pce
1023050	20-15CU-20 l=300mm	39	302	39	17	17	6+10	30	2	pce

Uponor Q&E

Uponor Aqua PLUS

Specification

- Watertight cabinets according to NT VVS 129
- For manifolds with c/c 50 mm
- For M7 cabinet sleeves
- Includes cabinte, splash covers and accesory kit with manifold clips
- Doors and frames (if needed) should be ordered separately
- RAL 9010
- Plastic manifolds for installation in Watertight cabinets
- Manifolds and accesories can be used separtelly
- In case of use only manifolds without cabintes system watertightness acc to NT VVS 129 cannot be guaranteed
- Metal fittings are made of high quality brass
- Plastic fittings are made of polyphenilsulphone
- PPM manifolds with bayonet threads

Application

- Watertight installations to prevent from damages in case of leakage
- All types of manifold installations

Uponor Aqua PLUS manifold Q&E PPM

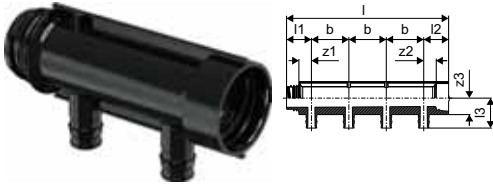

Item no.	Dimension	outlets	l	l1	l2	l3	z1	z2	z3	b	p	Qty 2	Qty 1	UOM
		-	mm	mm	mm	mm	mm	mm	mm	mm	mm			
1047999	1" 2X16 c/c50mm	2	117	33	33	40	17	17	22	50	6+10	10	1	pce
1048000	1" 3X16 c/c50mm	3	167	33	33	40	17	17	22	50	6+10	8	1	pce
1048001	1" 4X16 c/c50mm	4	217	33	33	40	17	17	22	50	6+10	6	1	pce

Uponor Aqua PLUS manifold PPM

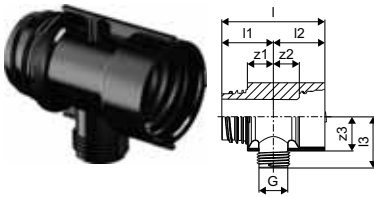

Item no.	Dimension	outlets	l	l1	l2	l3	G	z1	z2	z3	p	Qty 2	Qty 1	UOM
		-	mm	mm	mm	mm	inch	mm	mm	mm	mm			
1047997	1" 1XG1/2"MT c/c50mm	1	67	33	33	33	1/2"	17	17	23	6+10	20	1	pce
1047998	1" 1XG3/4"MT c/c50mm	1	67	33	33	33	3/4"	17	17	23	6+10	20	1	pce

Uponor Q&E

Uponor Aqua PLUS manifold PPM

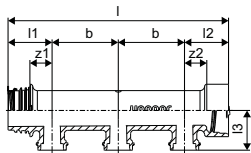

Item no.	Dimension	l	l1	l2	l3	z1	z2	b	p	Qty 2	Qty 1	UOM
		mm	mm	mm	mm	mm	mm	mm	bar			
1087121	3X c/c50mm	167	33	33	30	17	17	50	6+10	8	1	pce
1087122	2X c/c50mm	117	33	33	30	17	17	50	6+10	10	1	pce
1087123	1X c/c50mm	67	33	33	30	17	17	50	6+10	20	1	pce

Uponor Aqua PLUS manifold PPM

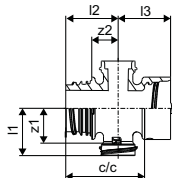

Item no.	Dimension	l1	l2	l3	c/c	z1	z2	p	Qty 2	Qty 1	UOM
		mm	mm	mm	mm	mm	mm	bar			
1087124	1+1X c/c50mm	30	33	33	50	22	17	6+10	15	1	pce

Uponor Aqua PLUS Outlet Valve PPM Blue

- Plastic shut-off valve with bayonet connection for easy installation to PPM manifolds and adapters. 90° turn to open/close.



NEW

Item no.	Qty 2	Qty 1	UOM
1096407	50	1	pce

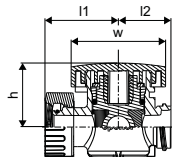

Uponor Aqua PLUS Outlet Valve PPM Red

- Plastic shut-off valve with bayonet connection for easy installation to PPM manifolds and adapters. 90° turn to open/close.



NEW

Item no.	Qty 2	Qty 1	UOM
1096408	50	1	pce

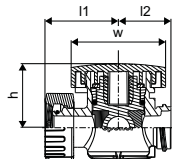

Uponor Q&E

Uponor Aqua PLUS Q&E adapter PPSU PPM

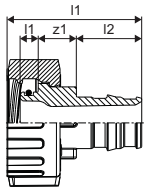

Item no.	Dimension	l mm	l1 mm	l2 mm	z1 mm	Qty 2	Qty 1	UOM
1087112	16	37	5	18	11	30	1	pce
1087113	20	48	5	17	22	30	1	pce

Uponor S-Press adapter Aqua PLUS PPM

- adapter Aqua PLUS

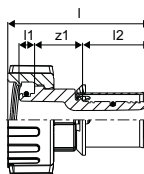

Item no.	Dimension	l mm	l1 mm	l2 mm	z1 mm	Qty 2	Qty 1	UOM
1087116	16	46	5	22	15	30	1	pce
1087117	20	48	5	24	15	30	1	pce

Uponor Aqua PLUS outlet plug PPSU PPM

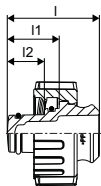

Item no.	l mm	l1 mm	l2 mm	Qty 2	Qty 1	UOM
1087110	31	18	13	30	1	pce

Uponor Aqua PLUS outlet nut PPSU PPM

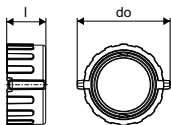

Item no.	l mm	do mm	Qty 2	Qty 1	UOM
1087120	15	35	30	5	pce

Uponor Q&E

Uponor Aqua PLUS adapter male thread PPM

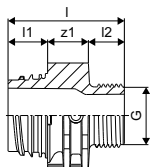

Item no.	Dimension	l	l1	l2	G	z1	p	Qty 2	Qty 1	UOM
		mm	mm	mm	inch	mm	bar			
1048002	1" G3/4"MT	49	17	15	3/4	17	6+10	20	1	pce

Uponor Aqua PLUS adapter brass nut PPM

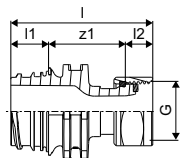

Item no.	Dimension	outlets	l	l1	l2	G	z1	Qty 2	Qty 1	UOM
		-	mm	mm	mm	inch	mm			
1063785	1"MT-G3/4"SN	2	62	17	12	3/4	34	20	1	pce

Uponor Aqua PLUS adapter brass nut PPM

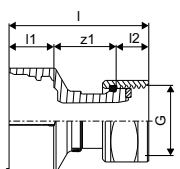

Item no.	Dimension	l	l1	l2	G	z1	Qty 2	Qty 1	UOM
		mm	mm	mm	inch	mm			
1063811	1"FT-3/4"SN	51	17	12	3/4	23	25	1	pce

Uponor Aqua PLUS elbow adapter male PPM

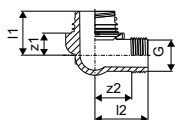

Item no.	Dimension	l1	l2	G	z1	z2	Qty 2	Qty 1	UOM
		mm	mm	inch	mm	mm			
1048003	1" G3/4"MT	33	40	3/4	17	28	20	1	pce

Uponor Q&E

Uponor Aqua PLUS elbow male female PPM

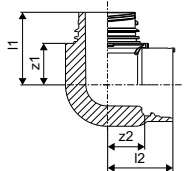

Item no.	Dimension	l1 mm	l2 mm	z1 mm	z2 mm	Qty 2	Qty 1	UOM
1063782	1"MT-1"FT	39	35	22	20	20	1	pce

Uponor Aqua PLUS manifold end cap PPM

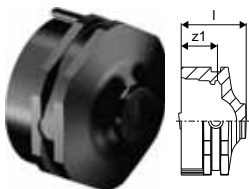

Item no.	Dimension	l mm	z1 mm	Qty 2	Qty 1	UOM
1048004	1"FT	27	15	20	1	pce

Uponor Aqua PLUS end cap, air nipple PPM

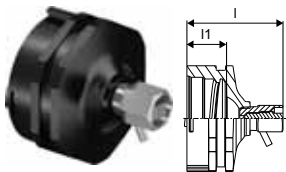

Item no.	Dimension	l mm	l1 mm	Qty 2	Qty 1	UOM
1048005	1"FT	40	17	20	1	pce

Uponor Aqua PLUS manifold plug PPM



Item no.	Dimension	l mm	l1 mm	Qty 2	Qty 1	UOM
1087119	MT	30	12	30	1	pce

Uponor Aqua PLUS manifold bracket PPM

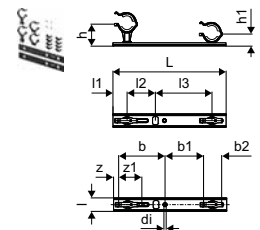

Item no.	l mm	l1 mm	l2 mm	l3 mm	L m	di mm	z mm	z1 mm	b mm	b1 mm	b2 mm	h mm	h1 mm	Qty 2	Qty 1	UOM
1092021	36	38	75	150	300	6	14	62	123	102	48	58	32	50	1	set

Uponor Q&E

Uponor Aqua PLUS manifold clips PPM

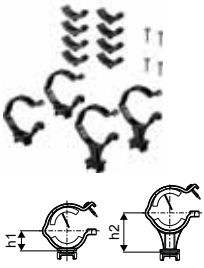

Item no.	h1 mm	h2 mm	Qty 2	Qty 1	UOM
1087375	28	50	20	1	set

Uponor Aqua PLUS watguard one valve PPM

1. Plastic membrane solenoid valve(s), Danfoss; EV228A 18P MIX E UN 000 code no. 042U819101 for Tap water PPM modular manifold system with Bayonet thread, grivory on the base valve unit, sealing in EPDM with silicon free lubricant, latching solenoid 12 V DC.
2. Wireless sensor(s) and connection box with sensor tape. wireless sensor and sensor tape, plastic cover, electronic circuit, 2 AA batteries. The sensor is indicating moisture and sends signal to the control unit.
3. Control unit with switches and indicators.



Item no.	Dimension	AG inch	IG inch	Qty 2	Qty 1	UOM
1063201	1"	1	1	10	1	set

Uponor Aqua PLUS watguard two valve PPM

1. Plastic membrane solenoid valve(s), Danfoss; EV228A 18P MIX E UN 000 code no. 042U819101 for Tap water PPM modular manifold system with Bayonet thread, grivory on the base valve unit, sealing in EPDM with silicon free lubricant, latching solenoid 12 V DC.
2. Wireless sensor(s) and connection box with sensor tape wireless sensor and sensor tape, plastic cover, electronic circuit, 2 AA batteries. The sensor is indicating moisture and sends signal to the control unit.
3. Control unit with switches and indicators.



Item no.	Dimension	AG inch	IG inch	Qty 2	Qty 1	UOM
1063202	1"	1	1	10	1	set

Uponor Aqua PLUS watguard off valve PPM

1. Plastic membrane solenoid valve, Danfoss; EV228A 18P MIX E UN 000 code no. 042U819101 for Tap water PPM modular manifold system with Bayonet thread, grivory on the base valve unit, sealing in EPDM with silicon free lubricant, latching solenoid 12 V DC.

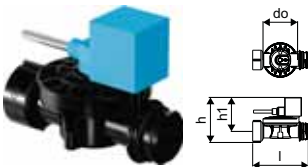

Item no.	Dimension	l mm	do mm	h mm	h1 mm	Qty 1	UOM
1063203	1"	111	69	90	68	1	set

Uponor Q&E

Uponor Aqua PLUS waterguard sensor

- wireless sensor and sensor tape, plastic cover, electronic circuit, 2 AA batteries. The sensor is indicating moisture and sends signal to the control unit.



Item no.	Qty 2	Qty 1	UOM
1063204	50	1	pce

Uponor Aqua PLUS manif end cap flat seal

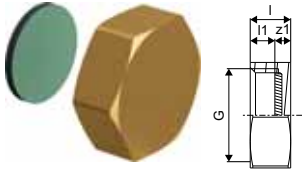

Item no.	Dimension	l	l1	G	z1	Qty 2	Qty 1	UOM
		mm	mm	inch	mm			
1001337	3/4"FT	12	7	3/4	5	250	10	pce

Uponor Flex-X

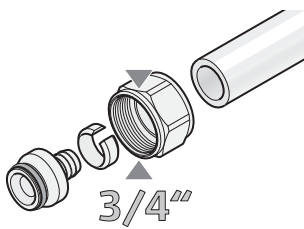

Uponor FLEX-X compression fittings are especially designed for the connection of Uponor flexible pipes with the 3/4" eurocone connection.

Your benefits

- Simple adaptation to 3/4" eurocone manifolds and fittings
- No special tools required



Uponor Flex-X adapter plated PEX

- Made of plated brass
- For connection of Uponor PE-Xa pipes to manifolds
- Female thread 3/4" eurocone acc. to DIN EN ISO 228-1.

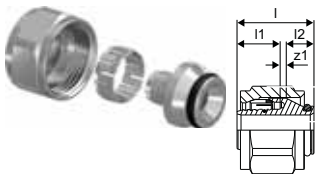

Item no.	Dimension	l	l1	G	z1	p	Qty 2	Qty 1	UOM
		mm	mm	inch	mm	bar			
1057441	16x1,8/2,0-3/4"FT Euro	24	16	3/4	1	6	100	10	pce
1045542	16x2,2-3/4"FT Euro	24	16	3/4	1	10	100	10	set
1057442	20X1,9/2,0-3/4"FT Euro	29	16	3/4	5	6	100	10	pce

Uponor Smart Radi adapter

- With 3/4FT eurocone, elastically sealing, for the connection of the coated copper pipe 15 x 1 mm of the Uponor press connection elbow, Uponor press connection tee to the tap battery, radiator or Uponor radiator connection adapter with 3/4FT eurocone.
- Coated brass union nut, brass clamp ring blank and sealing cone made of EPDM.
- Ribbed union nut with wrench size 27.

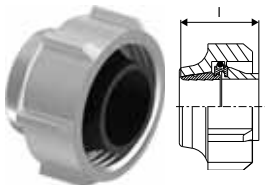

Item no.	Dimension	l	Qty 2	Qty 1	UOM
		mm			
1013830	15CU-3/4" Euro	21	80	10	pce

Uponor Smart Radi adapter sealed

- Made of coated brass
- self-sealing
- For the connection of radiators with 1/2 female thread connectors, 3/4 male thread eurocone for the connection of Cu-pipe, 15 x 1 mm, with clamp compression adapter.

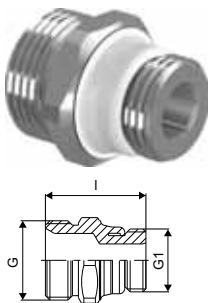

Item no.	Dimension	l	G	G1	Qty 2	Qty 1	UOM
		mm	inch	inch			
1013906	G3/4"MT-G1/2"MT	34	3/4	1/2	80	10	pce

Uponor Uni-X

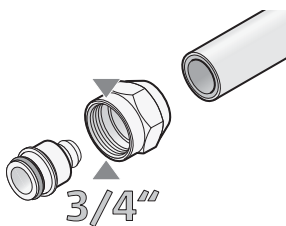

Uponor Uni-X is a compression fittings range of 3/4" eurocone connectors and adaptors for tap water and heating/cooling application.

Your benefits

- Simple adaption to other pipes and systems
- Flexible system design
- No special tools required



Application

- For the distribution of heating water for the radiator connection

Uponor Uni-X manifold H 1"SN

- Manifold made of stainless steel
- Flat-sealing connection 1" female thread including flat seal

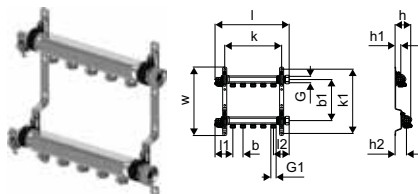

Item no.	Dimension	outlets	l	l1	l2	G	G1	b	b1	b2	h	h1	h2	k	k1	w	p	Qty 2	Qty 1	UOM
		-	mm	mm	mm	inch	inch	mm	mm	mm	mm	mm	mm	mm	mm	mm	bar			
1088873	2xG3/4 Euro	2	210	87	73	1	3/4	50	215	215	75	30	50	135	336	357	6	108	1	pce
1088874	3XG3/4 Euro	3	260	87	73	1	3/4	50	215	215	75	30	50	185	336	357	6	108	1	pce
1088875	4XG3/4 Euro	4	310	87	73	1	3/4	50	215	215	75	30	50	235	336	357	6	108	1	pce
1088876	5XG3/4 Euro	5	360	87	73	1	3/4	50	215	215	75	30	50	285	336	357	6	108	1	pce
1088877	6XG3/4 Euro	6	410	87	73	1	3/4	50	215	215	75	30	50	335	336	357	6	72	1	pce
1088878	7XG3/4 Euro	7	460	87	73	1	3/4	50	215	215	75	30	50	385	336	357	6	72	1	pce
1088879	8XG3/4 Euro	8	510	87	73	1	3/4	50	215	215	75	30	50	435	336	357	6	72	1	pce
1088880	9XG3/4 Euro	9	560	87	73	1	3/4	50	215	215	75	30	50	485	336	357	6	72	1	pce
1088881	10XG3/4 Euro	10	610	87	73	1	3/4	50	215	215	75	30	50	535	336	357	6	48	1	pce
1088882	11XG3/4 Euro	11	660	87	73	1	3/4	50	215	215	75	30	50	585	336	357	6	48	1	pce
1088883	12XG3/4 EURO	12	710	87	73	1	3/4	50	215	215	75	30	50	635	336	357	6	48	1	pce

Uponor RS

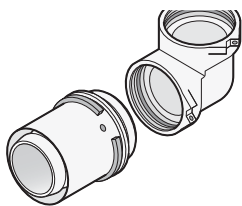

Uponor RS is a unique system that follows a modular design principle for riser systems and other distribution lines. Just 40 system components enable hundreds of variations, making the system highly adaptable.

Your benefits

- Innovative plug connection between body and adapter
- Fast and flexible: tool-free assembly, many variations
- More efficient stock management
- Re-adjustment possible until final installation
- Colour coding 16 -110mm for easy dimension selection



Uponor RS coupling

- Made of tin-plated brass
- Base part for all RS2 or RS3 inserts including 2 lock pins.



Item no.	Dimension	l mm	Qty 2	Qty 1	UOM
1029144	RS2-RS2	58	480	1	pce
1029145	RS3-RS3	58	480	1	pce

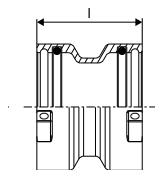

Uponor RS elbow

- Made of tin-plated brass
- Base part for all RS2 or RS3 inserts including 2 lock pins.



Item no.	Dimension	l1 mm	l2 mm	Qty 2	Qty 1	UOM
1029138	RS2-RS2	51	51	336	1	pce
1029139	RS3-RS3	68	68	240	1	pce

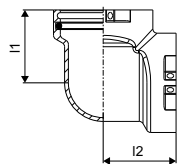

Uponor RS

Uponor RS elbow 45°

- Made of tin-plated brass
- Base part for all RS2 or RS3 inserts including 2 lock pins.

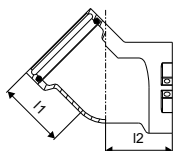

Item no.	Dimension	l1 mm	l2 mm	Qty 2	Qty 1	UOM
1029140	RS2-RS2	51	51	336	1	pce
1029141	RS3-RS3	68	68	175	1	pce

Uponor RS tee

- Made of tin-plated brass
- Base part for all RS2 or RS3 inserts including 3 lock pins.

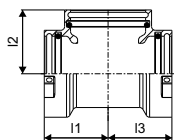

Item no.	Dimension	l1 mm	l2 mm	l3 mm	Qty 2	Qty 1	UOM
1029142	RS2-RS2-RS2	51	51	51	336	1	pce
1029143	RS3-RS3-RS3	68	68	68	175	1	pce

Uponor RS reducer

- Made of tin-plated brass
- Reducer from RS3 to RS2 including 1 lock pin.

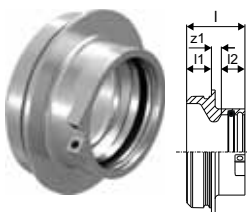

Item no.	Dimension	l mm	l1 mm	l2 mm	z1 mm	Qty 2	Qty 1	UOM
1029146	RS3-RS2	47	20	19	8	480	1	pce

Uponor RS spacer

- Made of tin plated-brass
- Spacer to connect RS base parts of equal dimensions.

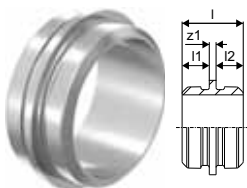

Item no.	Dimension	l mm	l1 mm	l2 mm	z1 mm	Qty 2	Qty 1	UOM
1046750	RS2-RS2 l=5mm	45	20	20	5	480	1	pce
1046751	RS3-RS3 l=5mm	45	20	20	5	240	1	pce

Uponor RS

Uponor RS spacer

- Made of tin-plated brass
- Spacer to connect RS base parts of equal dimensions e.g to create T-manifold or shift in distribution lines.

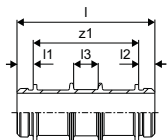

Item no.	Dimension	l mm	l1 mm	l2 mm	l3 mm	z1 mm	Qty 2	Qty 1	UOM
1046477	RS2-RS2 l=130mm	170	20	20	30	130	240	1	pce
1046478	RS3-RS3 l=210mm	250	20	20	30	210	96	1	pce

Uponor RS adapter PL Q&E

- RS
- Positive listed brass
- Uponor Q&E Ring must be ordered separately

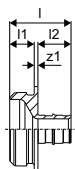

Item no.	Dimension	l mm	l1 mm	l2 mm	z1 mm	p mm bar	Qty 2	Qty 1	UOM
1047021	25-RS2	50	20	27	3	6+10	480	1	pce
1047022	32-RS2	57	20	34	3	6+10	480	1	pce
1047023	40-RS2	65	20	42	3	6+10	480	1	pce
1047024	50-RS2	75	20	52	3	6+10	400	1	pce
1047026	63-RS2	88	20	65	3	6+10	400	1	pce

Uponor RS adapter PL/DR Q&E

- RS
- DR brass
- Uponor Q&E Ring must be ordered separately

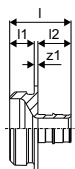

Item no.	Dimension	l mm	l1 mm	l2 mm	z1 mm	p mm bar	Qty 2	Qty 1	UOM
1085079	75-RS2	111	20	86	5	6+10	6	1	pce

Uponor Wipex RS adapter PN6

- RS = unique modular fitting connection
- 6 bar, SDR 11
- DR = dezincification resistance brass

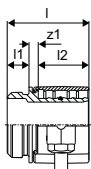

Item no.	Dimension	l mm	l1 mm	l2 mm	z1 mm	p bar	Weight kg	Qty 2	Qty 1	UOM
1047013	DR 63x5,8 RS2	75	46	20	9	6	0,94	240	1	pce
1047014	DR 75x6,8 RS2	84	46	20	18	6	1,28	240	1	pce
1047015	DR 90x8,2 RS3	93	59	20	14	6	2,07	180	1	pce
1047016	DR 110x10,0 RS3	105	71	20	14	6	2,67	180	1	pce

Uponor RS

Uponor Wipex RS adapter PN10

- RS = unique modular fitting connection
- 10 bar, SDR 7,4
- DR = dezincification resistance brass

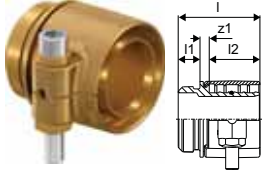

Item no.	Dimension	l mm	l1 mm	l2 mm	z1 mm	p bar	Weight kg	Qty 2	Qty 1	UOM
1047017	DR 63x8,6 RS2	75	20	46	9	10	0,95	240	1	pce
1047018	DR 75x10,3 RS2	83	20	51	12	10	1,33	240	1	pce
1047019	DR 90x12,3 RS3	92	20	59	13	10	2,21	180	1	pce
1047020	DR 110x15,1 RS3	104	20	71	13	10	3,01	180	1	pce

Uponor RS adapter male thread

- Made of tin-plated brass
- Fits to all RS2 or RS3 base parts

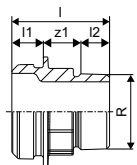

Item no.	Dimension	l mm	l1 mm	l2 mm	R inch	z1 mm	Qty 2	Qty 1	UOM
1059402	R1 1/2"MT-RS2	62	20	24	1 1/2	18	480	1	pce
1029131	R2"MT-RS2	66	20	23	2	23	480	1	pce
1029132	R2 1/2"MT-RS2	63	20	27	2 1/2	16	480	1	pce
1029133	R3"MT-RS3	73	20	30	3	23	240	1	pce

Uponor RS adapter female thread

- Made of tin-plated brass.
- fits to all RS2 or RS3 base parts

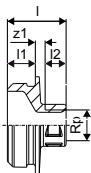

Item no.	Dimension	l mm	l1 mm	l2 mm	Rp inch	z1 mm	Qty 2	Qty 1	UOM
1059403	Rp1/2"FT-RS2	42	20	15	1/2	7	480	1	pce
1029134	Rp1"FT-RS2	45	20	19	1	6	480	1	pce
1029135	Rp2"FT-RS2	54	20	26	2	8	480	1	pce
1029136	Rp2 1/2"FT-RS2	63	20	30	2 1/2	12	480	1	pce
1059404	Rp1/2"FT-RS3	43	20	15	1/2	8	336	1	pce
1029137	Rp3"FT-RS3	65	20	33	3	12	240	1	pce

Uponor RS

Uponor RS flange adapter

- Made of tin-plated brass
- Fits to all RS2 or RS3 base parts
- Flange PN6/PN16 acc. to EN 1092-3
- Bolt circle with 4/8 holes.

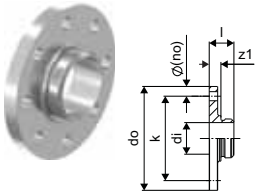

Item no.	Dimension	l	di	do	z1	k	p	Qty 2	Qty 1	UOM
		mm	mm	mm	mm	mm	bar			
1059398	RS2-DN65 (PN6)	38	48,7	160	18	130	6	144	1	pce
1059399	RS2-DN65 (PN16)	45	48,7	185	25	145	16	90	1	pce
1059400	RS3-DN80 (PN6)	38	78,1	190	18	150	6	90	1	pce
1029129	RS3-DN80 (PN16)	45	78,1	200	25	160	16	90	1	pce
1029130	RS3-DN100 (PN16)	44	78,1	220	24	180	16	90	1	pce
1059401	RS3-DN100 (PN6)	41	78,1	210	21	170	6	90	1	pce

Uponor RS lock pin

- made of plastic
- to lock the RS insert to the RS base part.



Item no.	Dimension	colour	Qty 2	Qty 1	UOM
1042921	RS2 black	black	5000	10	pce
1042922	RS3 grey	grey		10	pce

Uponor Minitec

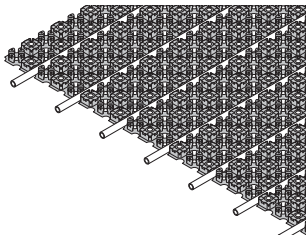

Uponor Minitec is the solution for underfloor heating on existing screed, timber or tiled floors. It has an installation height of only 15mm and consists of a self-adhesive foil element and PE-Xa pipe 9.9mm.

Minitec is optimised for near-surface heating in residential buildings.

Your benefits

- **Low height:** ideal for integration into renovations
- **Easy:** fast, efficient installation by one technician
- **Comfort:** short heat-up times, fast temperature control response
- **Energy saving:** low operating temperatures



Specification

- Minitec underfloor heating system for fixation on solid floors or specified insulation materials
- designed as sturdy pipe fixing system of minimum height, with integrated pipe laying channels for correct pipe laying distances
- for use with Uponor Minitec PE-Xa pipes 9.9 x 1.1 mm; allowing for straight and diagonal pipe laying
- EN 13501-1 fire classification: class E.
- standard flammability, building-material class B2, conforming to DIN 4102.
- Pipe spacing: Vz 5, 10, 15
- Net surface with overlapping nubs: 0,77m²

Application

- radiant underfloor heating and cooling
- very low construction height
- for use with qualified filler materials

Certification

- DIN CERTCO: 7F170-F

Uponor Comfort Pipe

Specification

- Pipes manufactured from peroxide cross-linked polyethylene (PE-Xa) acc. EN ISO 15875
- EVOH (ethylene vinyl alcohol) layer for oxygen diffusion resistance as per DIN 4726
- Application class 4 - Underfloor heating and low temperature radiators
- Fire classification E according to DIN EN 13501-1.

Application

- Underfloor heating and low temperature radiators
- Max design temperature: 90°C
- Malfunction temperature 100°C
- Design pressure 6 Bar at 70°C

Uponor Minitec

Uponor Minitec nubfoil self-adh

- Pipe fixation panel made of polystyrol, with overlap on both sides with triangular studs; perforated panel for installation between levelling compound and substructure; with self-adhesive back for proper fixture to screed and tiled floors.

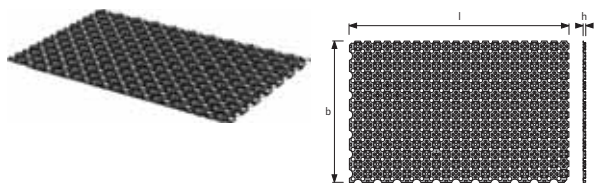

Item no.	Dimension	ND	l	b	h	A	colour	Area	Qty 2	Qty 1	UOM
		-	mm	mm	mm	m ²	-				
1005261	15,4m2 9,9x1,1 1100x700x12mm	15	1120	720	12	0,77	RAL 9017	0,806	123,2	15,4	m ²

Uponor Fix clamp track

- clamp track for pipe 9.9mm
- c-c 20mm

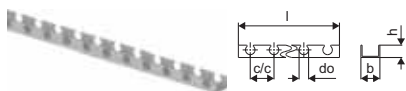

Item no.	Dimension	l	do	c/c1	b	colour	Qty 2	Qty 1	UOM
		mm	mm	mm	mm	-			
1005274	9,9mm c/c20mm 2,5m	2500	10	20	24	grey	25	2,5	m

Uponor Minitec edging strip, self-adh.

- Edging strip for Minitec system, conforming to DIN 18560, made of polyethylene with self-adhesive backing, self-adhesive strip on outer face provides tight seal between edging strip and insulation.

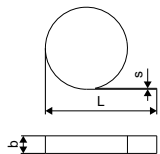

Item no.	Dimension	colour	Qty 2	Qty 1	UOM
		-			
1005267	20m 80x8mm	blue	200	20	m

Uponor Minitec expansion joint profile

- Self-adhesive profile of polyethylene foam expansion strip and hard-PVC body, for separation of screed sections (e.g. in doorways), and to absorb expansion of screed. For expansion joints as per DIN 18560-2.

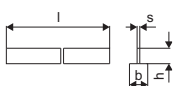

Item no.	Dimension	l	s	b	h	colour	Qty 2	Qty 1	UOM
		mm	mm	mm	mm	-			
1085980	0,9m 40x10mm	900	10,0	50	40	blue	600	10	pce
1085981	1,3m 40x10mm	1300	10	50	40	blue	600	10	pce

Uponor Minitec

Uponor Minitec Comfort Pipe

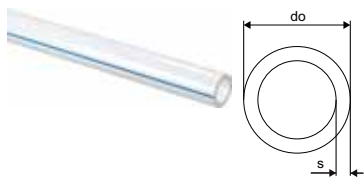

Item no.	Dimension	L m	do mm	s mm	p mm	colour	Qty 2	Qty 1	UOM
1063288	9,9x1,1	120m	120	9,9	1,1	6 natural	1680	120	m
1063289	9,9x1,1	240m	240	9,9	1,1	6 natural	2640	240	m
1063381	9,9x1,1	480m	480	9,9	1,1	6 natural	2880	480	m

Uponor Minitec joint protection tube

- Made of PE-LD, with slit opening, for protection of UFH pipes up to 9.9 mm in areas of expansion joints.

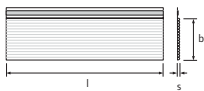
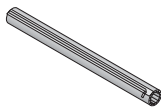

Item no.	Dimension	s mm	l mm	b mm	Qty 2	Qty 1	UOM
1005269	9,9mm 300x2mm	2,0	300	35	3600	30	pce

Uponor Vario adapter Minitec

- Eurocone
- Brass

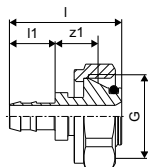

Item no.	Dimension	l mm	l1 mm	G inch	z1 mm	Qty 2	Qty 1	UOM
1005266	9,9x1,1-G3/4" Euro	35	14	3/4	14	100	10	pce

Uponor Minitec coupling, rings

- Q&E
- Brass
- With Q&E rings

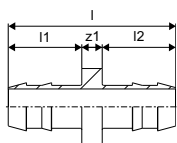

Item no.	Dimension	l mm	l1 mm	l2 mm	z1 mm	p mm	Qty 2	Qty 1	UOM
1005264	9,9x1,1	33	14	14	4	6	100	10	pce

Uponor Minitec

Uponor Minitec adapter male thread, ring

- Q&E
- Brass
- With Q&E ring

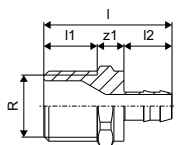

Item no.	Dimension	l mm	l1 mm	l2 mm	R inch	z1 mm	p bar	Qty 2	Qty 1	UOM
1005265	9,9-R1/2"MT	38	16	14	1/2	8	6	100	10	pce

Uponor Minitec ring natural

- PE-Xa

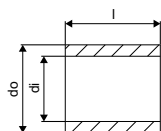

Item no.	Dimension	l mm	di mm	do mm	p bar	Qty 2	Qty 1	UOM
1005263	9,9x1,1	15	10,3	13,9	6	1600	10	pce

Uponor Minitec compression adapter fem

- 3/4 Euro

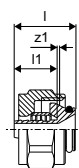

Item no.	Dimension	l mm	l1 mm	G inch	z1 mm	Qty 2	Qty 1	UOM
1013426	9,9-3/4"Euro	26	18	3/4	1	120	12	pce

Uponor Fluvia T pumpgroup Push-12 TH-G

- Pumpgroup with thermostat 12-28°C
- Secondary max. temperature limiter by 50°C

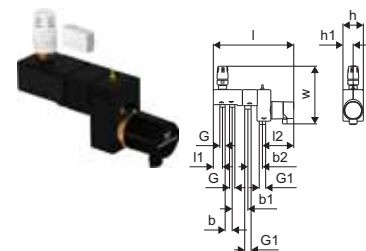

Item no.	l mm	l1 mm	l2 mm	G inch	G1 inch	b mm	b1 mm	b2 mm	h mm	h1 mm	w mm	Qty 2	Qty 1	UOM
1095127	332	38	129	5/8	3/4	40	65	65	84	42	240	60	1	pce

Uponor Minitec

Uponor Fluvia T pumpgroup Push-12 CH-G

- With cartridge heater for UFH in summer mode
- Room temperature control by controller X-161
- Compatible to Uponor Smatrix Wave thermostats T-166, T-168 , T-169
- With safety sensor against overheating
- Secondary max. temperature limiter by 50°C

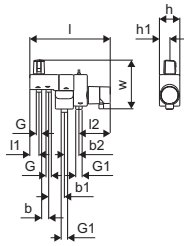

Item no.	Qty 2	Qty 1	UOM
1095131	30	1	pce

Uponor Fluvia T pumpgroup Push-12 AC-G

- Pumpgroup with actuator 230 V
- Secondary max. temperature limiter by 50°C

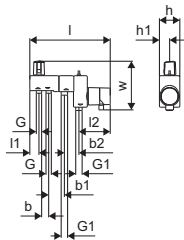

Item no.	Qty 2	Qty 1	UOM
1095128	60	1	pce

Uponor Fluvia T pumpgroup Push-12 WL-G

- Pumpgroup with actuator 230 V, wireless thermostat and wireless receiver
- Secondary max. temperature limiter by 60°C

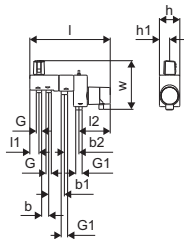

Item no.	Qty 2	Qty 1	UOM
1095130	60	1	pce

Uponor Minitec

Uponor Vario fill and drain valve

- For Pumpgroup Push 12



Item no.	Dimension	AG inch	IG inch	Qty 2	Qty 1	UOM
1061802	3/4" - 3/4"	3/4	3/4	10	1	set

Uponor Q&E expansion tool with heads M12



Item no.	Dimension	p bar	stroke mm	Qty 1	UOM
1063112	6BAR 9,9/20	6	14	1	set

Uponor Q&E head M12



Item no.	Dimension	stroke mm	Qty 1	UOM
1060702	9,9x1,1	14	1	pce

Uponor Tecto

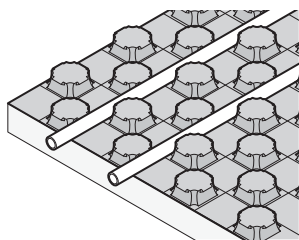

Uponor Tecto pipe positioning panels serve to install underfloor heating/cooling systems in residential and non-residential buildings. They are installed in the floor below the cement or anhydrite screed load

distribution layer, and are available in two thicknesses (ND 30-2 and ND 11) for various floor constructions and load-bearing requirements.

Your benefits

- Easy: optimally matched system components
- Choose between multilayer composite pipe or PE-Xa pipe
- Profit from long-term, proven Uponor quality



Specification

- Tecto nub panel underfloor heating system, consists of nub panels for fixation of pipe dimensions 14-17mm.
- for pipe spacing in cm: 10, 15, 20, 25, 30
- EN 13501-1 fire classification: class E
- standard flammability, building-material class B2, conforming to DIN 4102

Application

- radiant underfloor heating and cooling
- for use with cement- and anhydrite-based screeds

Certification

- DIN CERTCO: 7F010-F; 7F037-F

Uponor Comfort Pipe PLUS

Specification

- Pipes manufactured from peroxide cross-linked polyethylene (PE-Xa) acc. EN ISO 15875
- EVOH (ethylene vinyl alcohol) layer for oxygen diffusion resistance as per DIN 4726
- 5layer
- Outside white PE layer designed to protect against mechanical damages
- Application class 4/5 - Underfloor heating and low temperature radiators
- Fire classification E according to DIN EN 13501-1.

Application

- Underfloor heating and low temperature radiators
- Heating
- Max design temperature: 90°C
- Malfunction temperature 100°C
- Design pressure 6 Bar at 70°C

Uponor Tecto

Uponor Tecto nub panel

- EPS (HBCD free) thermal insulation panel
- with step-sound reduction

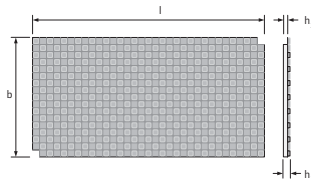

Item no.	Dimension	s	G	l	R-value	b	h2	A	Area	Qty 2	Qty 1	UOM
		MN/m ³	kN/m ²	mm	m ² K/W	mm	mm	m ²				
1005478	EPS DES 30-2mm 14-17mm 1450x850mm	20	5	1450	0,750	850	30-2	1,12	1,23	53,76	8,96	m ²

Uponor Tecto nub panel

- EPS (HBCD free) thermal insulation panel

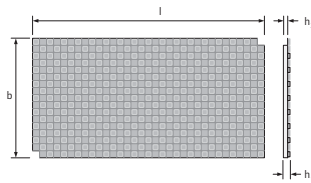

Item no.	Dimension	s	G	l	R-value	b	h2	A	Area	Qty 2	Qty 1	UOM
		MN/m ³	kN/m ²	mm	m ² K/W	mm	mm	m ²				
1005477	EPS 11mm 14-17mm 1450x850mm	-	30	1450	0,275	850	11	1,12	1,23	94,08	15,68	m ²

Uponor Tecto diagonal pipe fixation

- single pipe fixation for use with Tecto panels
- consists 3 single fixations



Item no.	Dimension	b	Qty 2	Qty 1	UOM
		mm			
1005482	45° 75mm	75	1680	10	pce

Uponor Tecto double strip element, foil

- for jointing of butt-joint Tecto panels

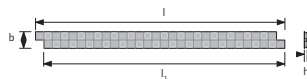

Item no.	Dimension	l	l1	b	h	Qty 2	Qty 1	UOM
		mm	mm	mm	mm			
1005484	1,4m 100mm	1400	1350	100	22	742,5	33,75	m

Uponor Tecto

Uponor Tecto expansion element foil

- expansion element to cover passages
- Tecto nub design

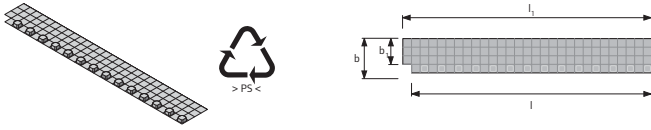

Item no.	Dimension	l mm	l1 mm	b mm	b1 mm	A m ²	Qty 2	Qty 1	UOM
1005481	1,45m 200mm	1400	1450	200	150	0,21	504	28	m

Uponor Tecto expansion element

- Heat-/sound insulation for use with the expansion element foil in door or wall area.
- EPS (HBCD free) acc. to EN 13163
- Thermal resistance: 0.75 m²K/W.
- Approved for moving loads of up to 5 kN/m².



Item no.	Dimension	G kN/m ²	ND -	l mm	R-value m ² K/W	b mm	h mm	A m ²	Qty 2	Qty 1	UOM
1005480	EPS DES 30-2mm 150x1400mm	5	30-2	1400	0,750	150	30-2	0,21	268,8	8,4	m

Uponor Tecto expansion element

- Heat-/sound insulation for use with the expansion element foil in door or wall area.
- EPS (HBCD free) acc. to EN 13163
- Thermal resistance: 0.275 m²K/W.
- Approved for moving loads of up to 30 kN/m².



Item no.	Dimension	G kN/m ²	ND -	l mm	R-value m ² K/W	b mm	h mm	A m ²	Qty 2	Qty 1	UOM
1005479	EPS 11mm 150x1400mm	30	11	1400	0,275	150	11	0,21	716,8	22,4	m

Uponor Comfort Pipe PLUS

- 6/10 bar at 90°C/70°C

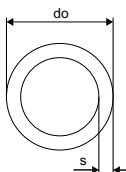

Item no.	Dimension	L m	do mm	s mm	p bar	colour -	Qty 2	Qty 1	UOM
1062883	14x2,0 120m	120	14	2,0	6	white	1320	120	m
1062884	14x2,0 240m	240	14	2	6	white	1680	240	m
1062885	14x2,0 960m	960	14	2,0	6	white	1920	960	m
1062044	16x2,0 120m	120	16	2,0	6	white	1080	120	m
1062045	16x2,0 240m	240	16	2	6	white	1440	240	m
1062046	16x2,0 640m	640	16	2	6	white	1280	640	m

Uponor Tecto

Uponor Comfort Pipe PLUS

- 6/8 bar at 90°C/70°C

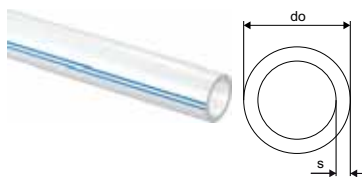

Item no.	Dimension	L m	do mm	s mm	p bar	colour	Qty 2	Qty 1	UOM
1034535	17x2,0	120m	120	17	2,0	6 white	840	120	m
1009226	17x2,0	240m	240	17	2	6 white	1200	240	m
1009227	17x2,0	640m	640	17	2	6 white	1280	640	m

Uponor Vario compression adapter PEX

- Eurocone
- Brass

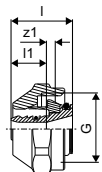

Item no.	Dimension	l mm	l1 mm	G inch	z1 mm	Qty 2	Qty 1	UOM
1065283	14x2,0-G3/4"FT Euro	23	13	3/4	3	25	1	pce
1065284	16x1,8/2,0-G3/4"FT Euro	23	13	3/4	3	25	1	pce
1065286	17x2,0-G3/4"FT Euro	23	13	3/4	3	25	1	pce

Uponor Q&E coupling, rings DR

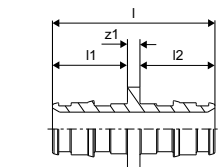

Item no.	Dimension	l mm	l1 mm	l2 mm	z1 mm	Qty 2	Qty 1	UOM
1058659	14-14	39	18	18	3	100	10	pce
1058660	16x1,8/2,0-16x1,8/2,0	39	18	18	3	100	10	pce
1058661	17-17	43	20	20	3	100	10	pce

Uponor Q&E ring natural, eval

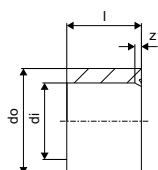

Item no.	Dimension	l mm	di mm	s mm	Qty 2	Qty 1	UOM
1058428	14	14	14,3	3,0	900	20	pce

Uponor Nubos

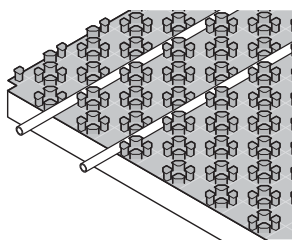

Uponor Nubos is specially designed for underfloor heating/cooling systems in residential and non-residential buildings. The panels are installed in the floor below the cement or anhydrite screed load

distribution layer. They are available in three different thicknesses (ND 30-2, ND 11 and nubfoil without insulation) for various floor constructions and load-bearing requirements.

Your benefits

- Easy: very few, optimally matched system components
- Choose between multilayer composite pipe or PE-Xa pipe (DIM 14/16)
- Profit from long-term, proven Uponor quality



Specification

- Nubos nub panel underfloor heating system, consists of nub panels for fixation of pipe dimensions 14-16mm.
- for pipe spacing in cm: 5,5, 11, 16,5, 22, 27,5 33
- EN 13501-1 fire classification: class E
- standard flammability, building-material class B2, conforming to DIN 4102

Application

- radiant underfloor heating and cooling
- for use with cement- and anhydrite-based screeds

Certification

- DIN CERTCO: 7F335-F, 7F336-F, 7F337-F, 7F338-F

Uponor Comfort Pipe PLUS

Specification

- Pipes manufactured from peroxide cross-linked polyethylene (PE-Xa) acc. EN ISO 15875
- EVOH (ethylene vinyl alcohol) layer for oxygen diffusion resistance as per DIN 4726
- 5layer
- Outside white PE layer designed to protect against mechanical damages
- Application class 4/5 - Underfloor heating and low temperature radiators
- Fire classification E according to DIN EN 13501-1.

Application

- Underfloor heating and low temperature radiators
- Heating
- Max design temperature: 90°C
- Malfunction temperature 100°C
- Design pressure 6 Bar at 70°C

Uponor Nubos

Uponor Nubos panel

- EPS (HBCD free) thermal insulation panel
- with step-sound reduction

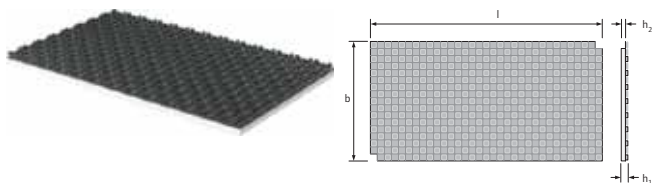

Item no.	Dimension	s	G	l	R-value	b	h2	A	colour	Area	Qty 2	Qty 1	UOM
		MN/m ³	kN/m ²	mm	m ² K/W	mm	mm	m ²	-				
1016699	EPS 30-2 14-16mm 1447x900x48mm	20	5	1447	0,750	900	30-2	1,25	RAL 9017	1,302	60	10	m ²

Uponor Nubos panel

- EPS (HBCD free) thermal insulation panel

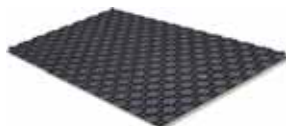

Item no.	Dimension	s	G	l	R-value	b	h2	A	colour	Area	Qty 2	Qty 1	UOM
		MN/m ³	kN/m ²	mm	m ² K/W	mm	mm	m ²	-				
1016700	EPS 11 14-16mm 1447x900x29mm	-	30	1447	0,275	900	11	1,25	RAL 9017	1,302	100	10	m ²

Uponor Nubos foil

- Pipe fixation panel for installation on existing insulation

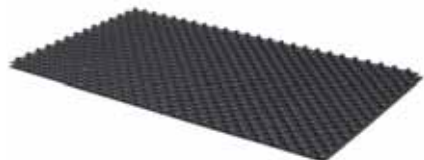

Item no.	Dimension	s	l	b	h1	A	colour	Area	Qty 2	Qty 1	UOM
		MN/m ³	mm	mm	mm	m ²	-				
1016703	14-16mm	-	1447	900	18	1,25	RAL 9017	1,302	140	10	m ²
1061880	14-16mm		1447	900	18	1,25	RAL 9017	1,302		200	m ²

Uponor Comfort Pipe PLUS

- 6/10 bar at 90°C/70°C

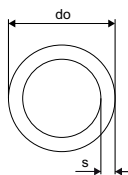

Item no.	Dimension	L	do	s	p	colour	Qty 2	Qty 1	UOM
		m	mm	mm	bar	-			
1062883	14x2,0 120m	120	14	2,0	6	white	1320	120	m
1062884	14x2,0 240m	240	14	2	6	white	1680	240	m
1062885	14x2,0 960m	960	14	2,0	6	white	1920	960	m
1062044	16x2,0 120m	120	16	2,0	6	white	1080	120	m
1062045	16x2,0 240m	240	16	2	6	white	1440	240	m
1062046	16x2,0 640m	640	16	2	6	white	1280	640	m

Uponor Nubos

Uponor Vario compression adapter PEX

- Eurocone
- Brass

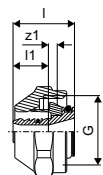

Item no.	Dimension	l mm	l1 mm	G inch	z1 mm	Qty 2	Qty 1	UOM
1065283	14x2,0-G3/4"FT Euro	23	13	3/4	3	25	1	pce
1065284	16x1,8/2,0-G3/4"FT Euro	23	13	3/4	3	25	1	pce

Uponor Q&E coupling, rings DR

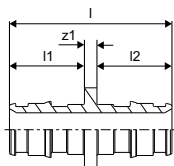

Item no.	Dimension	l mm	l1 mm	l2 mm	z1 mm	Qty 2	Qty 1	UOM
1058660	16x1,8/2,0-16x1,8/2,0	39	18	18	3	100	10	pce

Uponor Klett

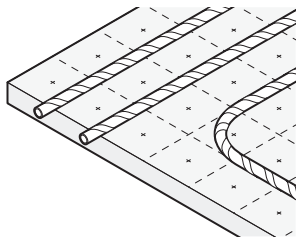

Innovative pipe-laying system for underfloor heating and cooling. Pipes have hook fastening tape wound around them; the insulating panel is covered with matching laminated loop foil. When the pipes are pressed into the

correct position against the laminated panel, the hooks catch the foil loops and secure the pipe, guaranteeing maximum fixture.

Your benefits

- **Reliable and fast:** micro-interlocking fixation
- **Easy:** no special tools needed
- **Flexible:** repositioning of pipes at any time
- **Choose between multilayer composite pipe or PE-Xa pipe (DIM 14/16)**
- **Profit from long-term, proven Uponor quality**



Specification

- Klett underfloor heating panel system, consists of Klett-foil for hook- and loop fixation laminated onto EPS according to EN 13163 and DIN 4108-10.
- based on hook- and loop fixation of Klett-pipes to insulation panels
- EN 13501-1 fire classification: class E
- standard flammability, building-material class B2, conforming to DIN 4102
- with self-adhesive tape at long side
- foil on the panel is printed with 100x100mm grid pattern

Application

- radiant underfloor heating and cooling
- for use with cement- and anhydrite-based screeds

Certification

- DIN CERTCO: 3V372 PE-Xa; 7F235-F; 7F236-F; 7F342-F

Uponor Klett MLCP RED

Specification

- Diffusion-tight multi layer composite pipe (PE-RT - adhesive agent - longitudinally welded aluminium - adhesive agent - PE-RT)

Application

- for radiant heating / cooling applications
- Normally inflammable, materials classification B2 according to DIN 4102
- Max. continuous operation pressure: 4 bar at continuous operating temperature 60°C.

Uponor Klett

Uponor Klett Comfort Pipe PLUS

Specification

- Pipes manufactured from peroxide cross-linked polyethylene (PE-Xa) acc. EN ISO 15875
- EVOH (ethylene vinyl alcohol) layer for oxygen diffusion resistance as per DIN 4726
- 5layer
- Outside white PE layer designed to protect against mechanical damages
- Application class 4 - Underfloor heating and low tempertaure radiators
- Fire classification E according to DIN EN 13501-1.

Application

- Underfloor heating and low tempertaure radiators
- Heating
- Max design temperature: 90°C
- Malfunction temperature 100°C
- Design pressure 6 Bar at 70°C

Uponor Klett panel roll extra

- thermal insulation panel, consists of Klett-foil for hook- and loop fixation laminated onto EPS (HBCD free) according to EN 13163 and DIN 4108-10.
- with self-adhesive tape at long side
- panel roll
- with step-sound reduction



Item no.	Dimension	s MN/m ³	G kN/m ²	ND -	R-value m ² K/W	A m ²	Qty 2	Qty 1	UOM
1063402	EPS DES 25-2mm 10x1m	30	5	25-2	0,600	10	80	10	m ²
1063323	EPS DES 30-3mm 10x1m	20	4	30-3	0,65	10	80	10	m ²

Uponor Klett panel

- folded panel



Item no.	Dimension	s MN/m ³	G kN/m ²	ND mm	I mm	R-value m ² K/W	b mm	h mm	A m ²	Qty 2	Qty 1	UOM
03.21 1007234*	EPS DEO 15mm 2x1m	-	30	15	2000	0,38	1000	15	2	140	20	m ²

Uponor Klett

Uponor Klett twinboard

- underfloor fixation panel 2.400 x 1.000 x 3mm, folded, consists of loop layer, laminated onto plastic 3-layer structured-core panel
- fire classification acc. DIN EN 13501-1: class E
- for live loads up to 5kN/m² in application areas acc. DIN EN 1991-1-1:2010-12 table 6.1: A1-A3; B1-B3, C1-C5, D1-D2 and T1-T2
- tested and evaluated by expertise of KIWA TBU for lifetime of 50 years

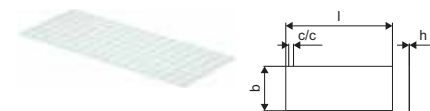

Item no.	Dimension	l mm	c/c mm	b mm	h mm	G kN/m ²	R-value m ² K/W	Qty 2	Qty 1	UOM
1086854	2400x1000x3mm	2400	100	1000	3	5	0,014	360	24	m ²

Uponor Multi tape roll

- self-adhesive tape for fixation of Tacker and Klett panels
- to result in screed-tightness acc DIN 18560



Item no.	Dimension	L m	b mm	Qty 2	Qty 1	UOM
100012	66m 50mm	66	50	36	1	pce

Uponor Multi UFHC roller manual

- or sticking down of insulation sections and edges, takes a roll of tape.



Item no.	Qty 2	Qty 1	UOM
1000142	20	1	pce

Uponor Klett Comfort Pipe PLUS

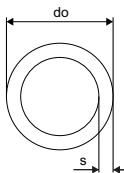

Item no.	Dimension	L m	do mm	s mm	p mm	colour	Qty 2	Qty 1	UOM
1087302*	16x2,0 240m	240	16	2	6	white	1200	240	m
1087303*	16x2,0 640m	640	16	2	6	white	1280	640	m

Uponor Klett

Uponor Vario compression adapter PEX

- Eurocone
- Brass

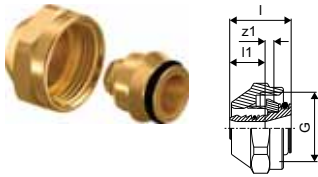

Item no.	Dimension	l	l1	G	z1	Qty 2	Qty 1	UOM
		mm	mm	inch	mm			
1065284	16x1,8/2,0-G3/4"FT Euro	23	13	3/4	3	25	1	pce

Uponor Q&E coupling, rings DR

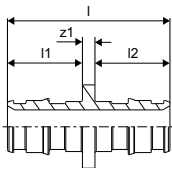

Item no.	Dimension	l	l1	l2	z1	Qty 2	Qty 1	UOM
		mm	mm	mm	mm			
1058660	16x1,8/2,0-16x1,8/2,0	39	18	18	3	100	10	pce

Uponor Klett MLCP red pipe



Item no.	Dimension	Qty 2	Qty 1	UOM
1096014	16X2,0 240M	1920	240	m
1096015	16X2,0 480M	2400	480	m

Uponor Uni-X compression adapter MLC

- Compression adapter, union nut and inner sleeve
- made of brass
- For connection of Uponor Uni Pipe PLUS and MLC pipes to manifolds (eg. Uponor manifold H).
- Female thread 3/4" eurocone according to EN ISO 228-1

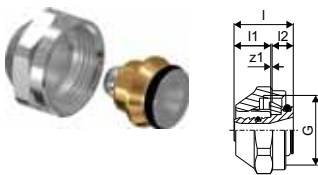

Item no.	Dimension	l	l1	G	z1	Qty 2	Qty 1	UOM
		mm	mm	inch	mm			
1058090	16-3/4"FT Euro	23	13	3/4	3	25	1	pce

Uponor Multi pipe support

- multifunctional tool for fixation and use inside building for easy uncoiling and guidance of Uponor underfloor heating pipes



Item no.	Qty 1	UOM
1088066	1	pce

Uponor Tacker

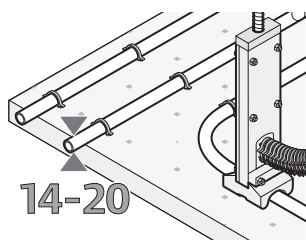

All components of the Uponor Tacker system are designed to perfectly match each other. The panels with thermal and step sound insulation are equipped with tear-proof surface and printed installation grid. They

enable easy installation of system pipes. All components are designed to ensure optimum safety and reliable operation.

Your benefits

- Flexible: composite panels or rolls, different thermal & step sound insulation layers
- Suitable for all types of screeds
- Fast to install: integrated insulation layer and cover
- Universal pipe clips for pipe thickness 14 – 20mm
- Easy installation: ergonomically designed stapler



Specification

- Tacker underfloor heating panel system, consists of tear-resistant fabric foil laminated onto EPS according to EN 13163 and DIN 4108-10.
- EN 13501-1 fire classification: class E
- standard flammability, building-material class B2, conforming to DIN 4102
- foil on the panel is printed with 100x100mm grid pattern

Application

- radiant underfloor heating and cooling
- for use with cement- and anhydrite-based screeds

Certification

- DIN CERTCO: 7F077-F, 7F185-F, 7F216-F, 7F278-F

Uponor Comfort Pipe PLUS

Specification

- Pipes manufactured from peroxide cross-linked polyethylene (PE-Xa) acc. EN ISO 15875
- EVOH (ethylene vinyl alcohol) layer for oxygen diffusion resistance as per DIN 4726
- 5layer
- Outside white PE layer designed to protect against mechanical damages
- Application class 4/5 - Underfloor heating and low temperature radiators
- Fire classification E according to DIN EN 13501-1.

Application

- Underfloor heating and low temperature radiators
- Heating
- Max design temperature: 90°C
- Malfunction temperature 100°C
- Design pressure 6 Bar at 70°C

Uponor Tacker

Uponor Tacker roll EPS DES

- thermal insulation panel
- panel roll
- with step-sound reduction

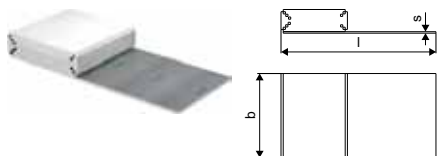

Item no.	Dimension	l mm	b mm	b1 mm	b2 mm	h mm	s mm	G MN/m ³	R-value kN/m ² m ² K/W	Qty 2	Qty 1	UOM
1090921	20-2mm 10x1m	10000	1030	1000	1000	20	30	5	0,500	100	10	m ²
03.21 1090922	25-2mm 10x1m	10000	1030	1000	1000	25	30	5	0,600	80	10	m ²

Uponor Tacker roll EPS DES

- thermal insulation panel
- foil on the panel is printed with 100x100mm grid pattern
- panel roll
- with step-sound reduction

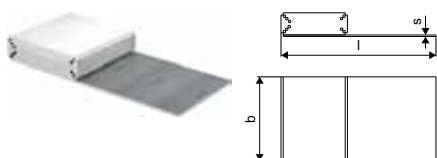

Item no.	Dimension	l mm	b mm	b1 mm	b2 mm	h mm	s mm	G MN/m ³	R-value kN/m ² m ² K/W	Qty 2	Qty 1	UOM
1090924	30-2mm 10x1m	10000	1030	1000	1000	30	20	5	0,750	80	10	m ²
1090925	30-3mm 10x1m	10000	1030	1000	1000	30	20	4	0,650	80	10	m ²
1090926	35-3mm 10x1m	10000	1030	1000	1000	35	15	4	0,750	70	10	m ²

Uponor Multi UFHC roller manual

- or sticking down of insulation sections and edges, takes a roll of tape.



Item no.	Qty 2	Qty 1	UOM
1000142	20	1	pce

Uponor Fix clamp track fixer

- clamp track fixation clip
- for pipes 14-20mm

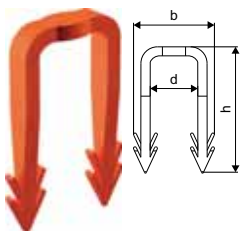

Item no.	di mm	b mm	h mm	Qty 2	Qty 1	UOM
1086533	15,8	27	42	5000	500	pce

Uponor Tacker

Uponor Comfort Pipe PLUS

- 6/10 bar at 90°C/70°C

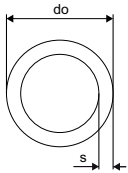

Item no.	Dimension	L m	do mm	s mm	p mm	colour	Qty 2	Qty 1	UOM
1062883	14x2,0 120m	120	14	2,0	6	white	1320	120	m
1062884	14x2,0 240m	240	14	2	6	white	1680	240	m
1062885	14x2,0 960m	960	14	2,0	6	white	1920	960	m
1062044	16x2,0 120m	120	16	2,0	6	white	1080	120	m
1062045	16x2,0 240m	240	16	2	6	white	1440	240	m
1062046	16x2,0 640m	640	16	2	6	white	1280	640	m

Uponor Comfort Pipe PLUS

- 6/8 bar at 90°C/70°C

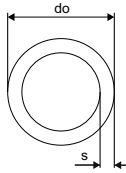

Item no.	Dimension	L m	do mm	s mm	p mm	colour	Qty 2	Qty 1	UOM
1034535	17x2,0 120m	120	17	2,0	6	white	840	120	m
1009226	17x2,0 240m	240	17	2	6	white	1200	240	m
1009227	17x2,0 640m	640	17	2	6	white	1280	640	m
1009228	20x2,0 120m	120	20	2	6	white	840	120	m
1009230	20x2,0 240m	240	20	2	6	white	960	240	m
1009231	20x2,0 480m	480	20	2	6	white	960	480	m

Uponor Vario compression adapter PEX

- Eurocone

- Brass

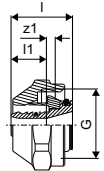

Item no.	Dimension	l mm	l1 mm	G inch	z1 mm	Qty 2	Qty 1	UOM
1065283	14x2,0-G3/4"FT Euro	23	13	3/4	3	25	1	pce
1065284	16x1,8/2,0-G3/4"FT Euro	23	13	3/4	3	25	1	pce
1065286	17x2,0-G3/4"FT Euro	23	13	3/4	3	25	1	pce
1065290	20x1,9/2,0-G3/4"FT Euro	24	14	3/4	3	25	1	pce

Uponor Tacker

Uponor Q&E coupling, rings DR

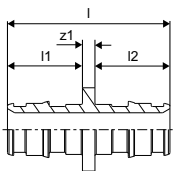

Item no.	Dimension	l mm	l1 mm	l2 mm	z1 mm	Qty 2	Qty 1	UOM
1058659	14-14	39	18	18	3	100	10	pce
1058660*	16x1,8/2,0-16x1,8/2,0	39	18	18	3	100	10	pce
1058661	17-17	43	20	20	3	100	10	pce
1058668	20-20	47	22	22	3	80	10	pce

Uponor Q&E ring natural, eval

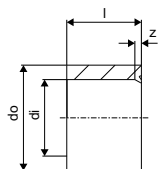

Item no.	Dimension	l mm	di mm	s mm	Qty 2	Qty 1	UOM
1058428	14	14	14,3	3,0	900	20	pce

Uponor Tacker pipe clip standard

- Tacker fixation clips
- for use with Uponor Tacker clip stapler

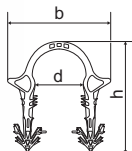

Item no.	Dimension	di mm	b mm	h mm	Qty 2	Qty 1	UOM
1086529	14-20mm h=40mm	19	38	40	75000	1000	pce

Uponor Tacker pipe clip long

- Tacker fixation clips
- for use with Uponor Tacker clip stapler

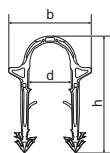

Item no.	Dimension	do mm	b mm	h mm	Qty 2	Qty 1	UOM
1086530	55mm	18,4	38	55	4800	300	pce

Uponor Tacker

Uponor Tacker clip stapler magazine

- Tacker tool
- for use with Uponor Tacker clips



03.21

Item no.	Dimension	Qty 2	Qty 1	UOM
1002295	14-20mm l=700mm	32	1	pce

Uponor Tacker stapling tool

- full metal
- lightweight
- for max 125 clips

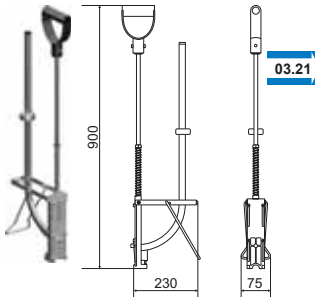

03.21

Item no.	Dimension	Qty 2	Qty 1	UOM
1119039	14-20mm	50	1	pce

Uponor Fix clamp track U-profile

- clamp track for pipes 14mm
- c-c 50mm

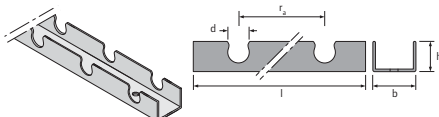

Item no.	Dimension	d mm	l mm	b mm	h mm	c/c mm	colour	Qty 1	UOM
1005498	14mm c/c50mm 2,5m	14	2500	38	17	50	grey	25	m

Uponor Fix clamp track with glue

- clamp track for pipes 14-20mm
- c-c 50mm
- with self-adhesive fixation



Item no.	Dimension	l mm	b mm	h mm	c/c mm	Qty 2	Qty 1	UOM
1000018	14-20mm c/c50mm 1m	1000	50	27	50	600	100	m

Uponor Fix 14-20

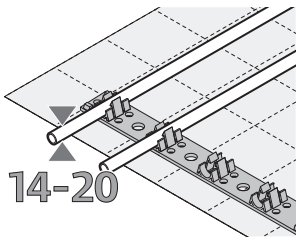

All components of the Uponor clamp track system are designed to perfectly match each other. The panels with thermal and step sound insulation are equipped with a tear-proof surface and printed

installation grid, enabling easy installation of system pipes. All components are designed to ensure optimum safety and reliable operation.

Your benefits

- Flexible pipe-laying: composite panels or rolls with different thermal and step sound insulation layers
- Large pipe coils: minimum cut-offs, twist-free installation
- Fast to install: integrated insulation layer and cover
- Universal for pipe dimensions of 14 – 20mm



Specification

- Fix system for pipe fixations in walls, ceiling and underfloor installations, consists of clamp tracks for pipe fixation.

Application

- radiant underfloor heating and cooling
- radiant wall and ceiling heating and cooling
- for use with cement- and anhydrite-based screeds

Certification

- DIN CERTCO: 7F277-W, 7F347-DW

Uponor Comfort Pipe PLUS

Specification

- Pipes manufactured from peroxide cross-linked polyethylene (PE-Xa) acc. EN ISO 15875
- EVOH (ethylene vinyl alcohol) layer for oxygen diffusion resistance as per DIN 4726
- 5layer
- Outside white PE layer designed to protect against mechanical damages
- Application class 4/5 - Underfloor heating and low temperature radiators
- Fire classification E according to DIN EN 13501-1.

Application

- Underfloor heating and low temperature radiators
- Heating
- Max design temperature: 90°C
- Malfunction temperature 100°C
- Design pressure 6 Bar at 70°C

Uponor Fix clamp track with glue

- clamp track for pipes 14-20mm
- c-c 50mm
- with self-adhesive fixation



Item no.	Dimension	l mm	b mm	h mm	c/c mm	Qty 2	Qty 1	UOM
100018	14-20mm c/c50mm 1m	1000	50	27	50	600	100	m

Uponor Fix 14-20

Uponor Comfort Pipe PLUS

- 6/10 bar at 90°C/70°C

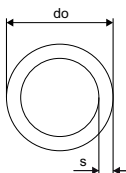

Item no.	Dimension	L m	do mm	s mm	p bar	colour	Qty 2	Qty 1	UOM
1062883	14x2,0	120m	120	14	2,0	6 white	1320	120	m
1062045	16x2,0	240m	240	16	2	6 white	1440	240	m
1062046	16x2,0	640m	640	16	2	6 white	1280	640	m

Uponor Comfort Pipe PLUS

- 6/8 bar at 90°C/70°C

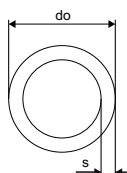

Item no.	Dimension	L m	do mm	s mm	p bar	colour	Qty 2	Qty 1	UOM
1034535	17x2,0	120m	120	17	2,0	6 white	840	120	m
1009226	17x2,0	240m	240	17	2	6 white	1200	240	m
1009227	17x2,0	640m	640	17	2	6 white	1280	640	m
1009228	20x2,0	120m	120	20	2	6 white	840	120	m
1009230	20x2,0	240m	240	20	2	6 white	960	240	m
1009231	20x2,0	480m	480	20	2	6 white	960	480	m

Uponor Vario compression adapter PEX

- Eurocone
- Brass

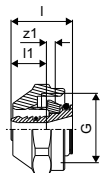

Item no.	Dimension	l mm	l1 mm	G inch	z1 mm	Qty 2	Qty 1	UOM
1065283	14x2,0-G3/4"FT Euro	23	13	3/4	3	25	1	pce
1065284	16x1,8/2,0-G3/4"FT Euro	23	13	3/4	3	25	1	pce
1065286	17x2,0-G3/4"FT Euro	23	13	3/4	3	25	1	pce
1065290	20x1,9/2,0-G3/4"FT Euro	24	14	3/4	3	25	1	pce

Uponor Q&E coupling, rings DR

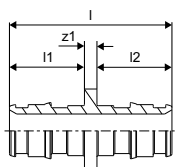

Item no.	Dimension	l mm	l1 mm	l2 mm	z1 mm	Qty 2	Qty 1	UOM
1058659	14-14	39	18	18	3	100	10	pce
1058660	16x1,8/2,0-16x1,8/2,0	39	18	18	3	100	10	pce
1058668	20-20	47	22	22	3	80	10	pce

Uponor Classic

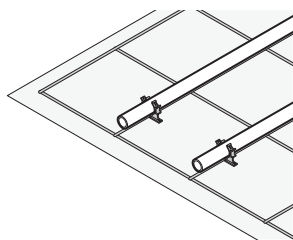

Uponor Classic is the ideal solution for underfloor heating/cooling systems in new residential and commercial buildings. Available in three grid sizes, it enables optimisation of pipe spacing to meet heating

needs. Combined with high-payload insulation, it is also suited for areas such as garage showrooms, production halls, retail outlets, etc.

Your benefits

- **Cost efficient:** flexible, fast and easy to install
- **Flexible:** choice of insulation material
- **Security:** no damage to insulation covering
- **Reliable:** long-term, proven system



Specification

- Classic underfloor heating system for installation on top of thermal/step-sound insulation provided by the customer.
- designed as steel-mesh supported fixation using single pipe clips

Application

- radiant underfloor heating and cooling
- for use with cement- and anhydrite-based screeds

Certification

- DIN CERTCO: 7F004-F; 7F371-F; 7F421-F

Uponor Comfort Pipe PLUS

Specification

- Pipes manufactured from peroxide cross-linked polyethylene (PE-Xa) acc. EN ISO 15875
- EVOH (ethylene vinyl alcohol) layer for oxygen diffusion resistance as per DIN 4726
- 5layer
- Outside white PE layer designed to protect against mechanical damages
- Application class 4/5 - Underfloor heating and low temperature radiators
- Fire classification E according to DIN EN 13501-1.

Application

- Underfloor heating and low temperature radiators
- Heating
- Max design temperature: 90°C
- Malfunction temperature 100°C
- Design pressure 6 Bar at 70°C

Uponor Classic

Uponor Classic steel mesh, coated

- steel mesh for mounting of pipe fixations of underfloor heating pipes
- material: coated steel

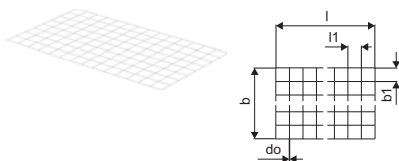

Item no.	Dimension	l mm	l1 mm	do mm	b mm	b1 mm	r mm	A m ²	Qty 2	Qty 1	UOM
1005084	100mm 2100x1200x3mm	2100	100	3	1200	100	100	2.5	750	25	m ²
1005087	150mm 2100x1200x3mm	2100	150	3	1200	150	150	2.5	750	25	m ²

Uponor Classic steel mesh

- steel mesh for mounting of pipe fixations of underfloor heating pipes
- material: steel

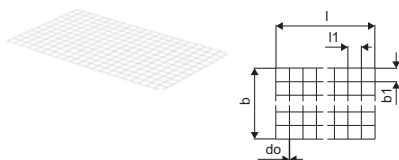

Item no.	Dimension	l mm	l1 mm	do mm	b mm	b1 mm	r mm	A m ²	Qty 2	Qty 1	UOM
1063406	100mm 2100x1200x3mm	2100	100	3	1200	100	100	2.5	750	25	m ²
1063407	150mm 2100x1200x3mm	2100	150	3	1200	150	150	2.5	750	25	m ²

Uponor Classic tying wire

- steel clip usable to fix pipe to steel mesh
- for use with Uponor tool for metallic clip



Item no.	Dimension	l mm	Qty 2	Qty 1	UOM
1009222	150x1,25mm 250pcs	150	250	1	pce

Uponor Comfort Pipe PLUS

- 6/10 bar at 90°C/70°C

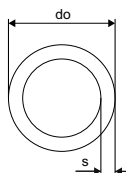

Item no.	Dimension	L m	do mm	s mm	p bar	colour	Qty 2	Qty 1	UOM
1062044	16x2,0 120m	120	16	2,0	6	white	1080	120	m
1062045	16x2,0 240m	240	16	2	6	white	1440	240	m
1062046	16x2,0 640m	640	16	2	6	white	1280	640	m

Uponor Classic

Uponor Comfort Pipe PLUS

- 6/8 bar at 90°C/70°C

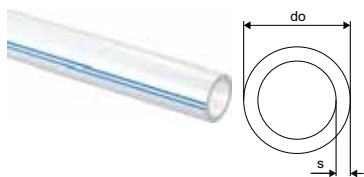

Item no.	Dimension	L m	do mm	s mm	p bar	colour	Qty 2	Qty 1	UOM
1034535	17x2,0	120m	120	17	2,0	6 white	840	120	m
1009226	17x2,0	240m	240	17	2	6 white	1200	240	m
1009227	17x2,0	640m	640	17	2	6 white	1280	640	m
1009228	20x2,0	120m	120	20	2	6 white	840	120	m
1009230	20x2,0	240m	240	20	2	6 white	960	240	m
1009231	20x2,0	480m	480	20	2	6 white	960	480	m

Uponor Vario compression adapter PEX

- Eurocone
- Brass

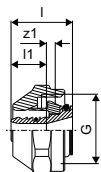

Item no.	Dimension	l mm	l1 mm	G inch	z1 mm	Qty 2	Qty 1	UOM
1065284	16x1,8/2,0-G3/4"FT Euro	23	13	3/4	3	25	1	pce
1065286	17x2,0-G3/4"FT Euro	23	13	3/4	3	25	1	pce
1065290	20x1,9/2,0-G3/4"FT Euro	24	14	3/4	3	25	1	pce

Uponor Q&E coupling, rings DR

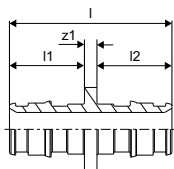

Item no.	Dimension	l mm	l1 mm	l2 mm	z1 mm	Qty 2	Qty 1	UOM
1058660*	16x1,8/2,0-16x1,8/2,0	39	18	18	3	100	10	pce
1058661	17-17	43	20	20	3	100	10	pce
1058668	20-20	47	22	22	3	80	10	pce

Uponor Siccus 14

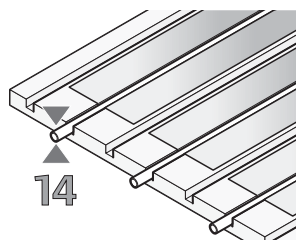

The universal Uponor Siccus 14 provides underfloor heating for new constructions as well as renovation projects, and is suitable for multiple construction styles. It is flexible and easy to apply in a variety of building

constructions.

Your benefits

- Low height and lightweight floor construction
- Fast to install: gypsum top layer makes it immediately accessible
- Quick and dry: no water, no drying time
- Universal: use with Dim 14mm MLC or PE-Xa pipe



Specification

- Siccus underfloor heating panel system, consists of EPS (HBCD-free) boards acc. EN 13163 with Aluminium heat spreaders.
- EN 13501-1 fire classification: class E.
- flame retardant class B1 acc. DIN 4102
- Application type acc to DIN 4108-10: DEO dh, WI
- life load acc. EN 1991-1-1 = 7,5kN/m²
- for installations with pipe c-c 150mm
- for pipe dim 14mm

Application

- radiant underfloor heating and cooling
- for dry-build installations
- for sports floors

Certification

- DIN CERTCO: 7F008-F, 7F009-F, 7F332-F

Uponor Comfort Pipe PLUS

Specification

- Pipes manufactured from peroxide cross-linked polyethylene (PE-Xa) acc. EN ISO 15875
- EVOH (ethylene vinyl alcohol) layer for oxygen diffusion resistance as per DIN 4726
- 5layer
- Outside white PE layer designed to protect against mechanical damages
- Application class 4/5 - Underfloor heating and low temperature radiators
- Fire classification E according to DIN EN 13501-1.

Application

- Underfloor heating and low temperature radiators
- Heating
- Max design temperature: 90°C
- Malfunction temperature 100°C
- Design pressure 6 Bar at 70°C

Uponor Siccus 14

Uponor Siccus 14 panel

- installation panel with grooves
- EPS compressive strength: = 150 kPa
- R=0.622 m²K/W

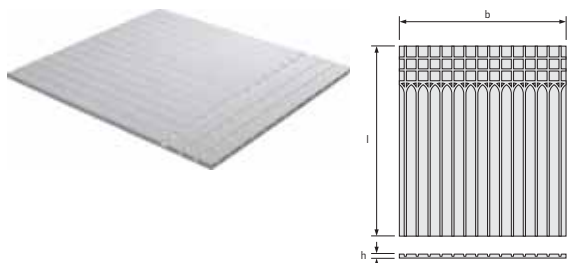

Item no.	Dimension	G kN/m ²	ND -	I mm	R-value m ² K/W	b mm	h mm	A m ²	Qty 2	Qty 1	UOM
1005485	EPS 150kPa 14mm 1197x1050x25mm	75	25	1197	0,622	1050	25	1,25	100	12,5	m ²

Uponor Multi PE edging strip with foil

- edging strip, conforming to DIN 18560, made of polyethylene, self-adhesive strip on outer face provides tight seal between edging strip and insulation

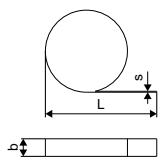

Item no.	Dimension	L m	s mm	b mm	colour	Qty 1	UOM
1000079	150x8mm	50	8	150	blue	200	m

Uponor Siccus 14 heat emission plate

- aluminium heat spreader for use in Uponor dry UFH systems using pipe 14mm
- pre-cut equipped for easy size to measure
- material consumption = 5.6 pcs/m² (c-c150mm)

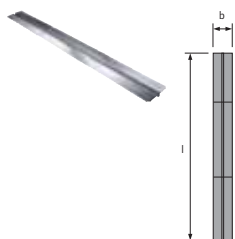

Item no.	Dimension	l mm	b mm	Qty 2	Qty 1	UOM
1005486	14mm 1180x120x0,45mm	1180	120	768	48	pce

Uponor Siccus 14

Uponor Multi foil PE

- PE-foil for installation on top of existing thermal insulation
- transparent

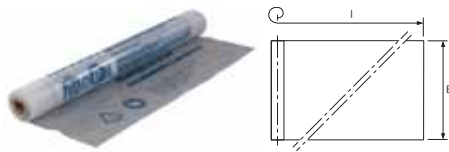

Item no.	Dimension	s mm	ND m	L m	B m	A m ²	colour	Qty 2	Qty 1	UOM
1005049	0,2mm 60x1,25m	0,2	0,2	60	1,25	75	transparent	3375	75	m ²

Uponor Comfort Pipe PLUS

- 6/10 bar at 90°C/70°C

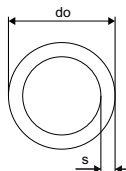

Item no.	Dimension	L m	do mm	s mm	p bar	colour	Qty 2	Qty 1	UOM
1062883	14x2,0 120m	120	14	2,0	6	white	1320	120	m
1062884	14x2,0 240m	240	14	2	6	white	1680	240	m
1062885	14x2,0 960m	960	14	2,0	6	white	1920	960	m

Uponor Vario compression adapter PEX

- Eurocone
- Brass

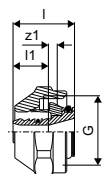

Item no.	Dimension	l mm	l1 mm	G inch	z1 mm	Qty 2	Qty 1	UOM
1065283	14x2,0-G3/4"FT Euro	23	13	3/4	3	25	1	pce

Uponor Fit compression adapter male PEX

- Brass

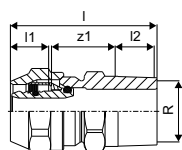

Item no.	Dimension	l mm	l1 mm	l2 mm	R inch	z1 mm	Qty 2	Qty 1	UOM
1065294	14x2,0-R1/2"MT	51	19	14	1/2	18	25	1	pce

Uponor Siccus 14

Uponor Fit compression adapter female PEX

- Brass

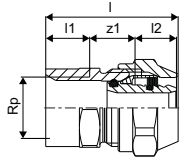

Item no.	Dimension	l	l1	l2	Rp	z1	Qty 2	Qty 1	UOM
		mm	mm	mm	inch	mm			
1065295	14x2,0-Rp1/2"FT	43	15	13	1/2	13	25	1	pce

Uponor Q&E coupling, rings DR

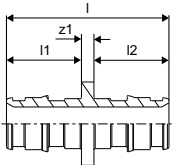

Item no.	Dimension	l	l1	l2	z1	Qty 2	Qty 1	UOM
		mm	mm	mm	mm			
1058659	14-14	39	18	18	3	100	10	pce

Uponor Q&E ring natural, eval

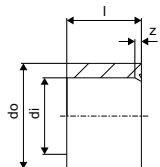

Item no.	Dimension	l	di	s	Qty 2	Qty 1	UOM
		mm	mm	mm			
1058428	14	14	14,3	3,0	900	20	pce

Uponor Siccus 14 PS cutter, groove

- thermal cutting tool for EPS
- 230V, 50/60Hz
- with tool to cut grooves for 14mm pipes



Item no.	Dimension	OV	Qty 2	Qty 1	UOM
		V			
1006290	14mm 230V	230	20	1	pce

Uponor Siccus FX

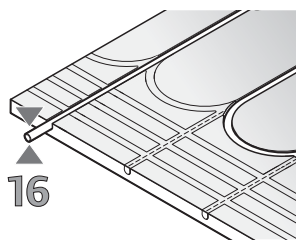

Uponor Siccus FX is an universal dry underfloor heating system with pre-fabricated full-face Aluminium top layer. Made for 16mm pipes and pipe pitch of 200mm, for use with Uponor PeXa and MLCP RED pipes.

Your benefits

- 'All in One' panel design
- Pre-formed 16mm pipe grooves
- Bonded heavy duty aluminium foil
- 100% emitter floor coverage area
- Multiple floor applications
- Dry trade only installation
- Reduced product inventory
- Ideal for renovation and new build projects



Specification

- Siccus underfloor heating panel system, consists of EPS (HBCD-free) panel acc. EN 13163 with full-face prefab Aluminium heat spreader layer.
- EN 13501-1 fire classification: class E
- life load acc. EN 1991-1-1: 5 kN/m²
- for installations with pipe c-c 200mm
- for pipe dim 16mm

Application

- radiant underfloor heating and cooling
- for dry-build installations
- very low construction height

Uponor Comfort Pipe PLUS

Specification

- Pipes manufactured from peroxide cross-linked polyethylene (PE-Xa) acc. EN ISO 15875
- EVOH (ethylene vinyl alcohol) layer for oxygen diffusion resistance as per DIN 4726
- 5layer
- Outside white PE layer designed to protect against mechanical damages
- Application class 4/5 - Underfloor heating and low temperature radiators
- Fire classification E according to DIN EN 13501-1.

Application

- Underfloor heating and low temperature radiators
- Heating
- Max design temperature: 90°C
- Malfunction temperature 100°C
- Design pressure 6 Bar at 70°C

Uponor Siccus FX

Uponor Siccus FX panel

- installation panel with AL-layer on top and inside grooves
- EPS Compressive strength: = 200 kPa
- R=0.9 m²K/W

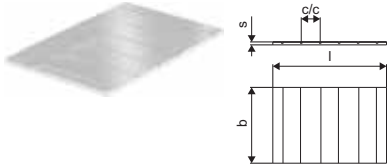

Item no.	Dimension	l mm	c/c mm	b mm	h mm	Lambda W/m ² K	G kN/m ²	R-value m ² K/W	Qty 2	Qty 1	UOM
1086316	1200x800x30mm	1200	200	800	31	0.033	5	0,900	40	10	pce

Uponor Comfort Pipe PLUS

- 6/10 bar at 90°C/70°C

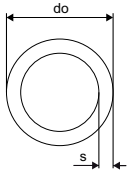

Item no.	Dimension	L m	do mm	s mm	p bar	colour	Qty 2	Qty 1	UOM
1062044	16x2,0 120m	120	16	2,0	6	white	1080	120	m
1062045	16x2,0 240m	240	16	2	6	white	1440	240	m
1062046	16x2,0 640m	640	16	2	6	white	1280	640	m

Uponor Q&E coupling, rings DR

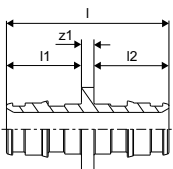

Item no.	Dimension	l mm	l1 mm	l2 mm	z1 mm	Qty 2	Qty 1	UOM
1058660	16x1,8/2,0-16x1,8/2,0	39	18	18	3	100	10	pce

Uponor Renovis

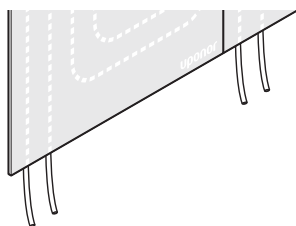

Uponor Renovis for radiant heating and cooling consists of gypsum plasterboard into which Uponor PE-Xa pipes are pre-integrated ex-works. Ideal for renovation, it enables thermal conditioning

of rooms via walls and ceilings by use of dry build constructions. For professional installation, the Tichelmann principle with complete Uponor portfolio is recommended.

Your benefits

- **Quick and dry:** professional installation time of about 3 rooms/day
- **Energy efficient:** low operating temperatures
- **All-in-one solution:** radiant heating/cooling and dry construction



Specification

- Renovis prefab heating and cooling panel system, with embedded pipes 9.9mm.
- based on fibre-reinforced gypsum panel 15mm
- EN 13501-1 fire classification: class E
- for mounting on defined dry-build sub constructions

Application

- radiant wall and ceiling heating and cooling
- for dry-build installations

Uponor Uni Pipe PLUS

Specification

- Oxygen diffusion resistant multi-layer composite pipe (PE-RT - adhesive – seamless aluminium/longitudinally welded aluminium - adhesive - PE-RT) produced using SACP and OWC-technology.
- Fire classification E according to EN 13501-1.
- With pipe end caps as hygienic seal according EN 806.

Application

- Tested/Approved according EN ISO 21003 Multilayer piping systems for hot and cold water installations inside buildings for application class 1,2,4,5/10bar
- Tap water: The permanent operating temperature ranges from 0°C to 70°C at a maximum permanent operating pressure of 10 bar. The short-term malfunction temperature is 95°C for a period of 100 hours in the operating life time.
- Heating: The permanent operating temperature ranges up to 80°C at a maximum permanent operating pressure of 10 bar. The short-term malfunction temperature is 100°C for a period of 100 hours in the operating life time.

Certification

- Approvals by local OM.

Uponor Renovis

Uponor Comfort Pipe

Specification

- Pipes manufactured from peroxide cross-linked polyethylene (PE-Xa) acc. EN ISO 15875
- EVOH (ethylene vinyl alcohol) layer for oxygen diffusion resistance as per DIN 4726
- Application class 4 - Underfloor heating and low temperature radiators
- Fire classification E according to DIN EN 13501-1.

Application

- Underfloor heating and low temperature radiators
- Max design temperature: 90°C
- Malfunction temperature 100°C
- Design pressure 6 Bar at 70°C

Uponor Comfort Pipe PLUS

Specification

- Pipes manufactured from peroxide cross-linked polyethylene (PE-Xa) acc. EN ISO 15875
- EVOH (ethylene vinyl alcohol) layer for oxygen diffusion resistance as per DIN 4726
- 5layer
- Outside white PE layer designed to protect against mechanical damages
- Application class 4/5 - Underfloor heating and low temperature radiators
- Fire classification E according to DIN EN 13501-1.

Application

- Underfloor heating and low temperature radiators
- Heating
- Max design temperature: 90°C
- Malfunction temperature 100°C
- Design pressure 6 Bar at 70°C

Uponor Renovis panel

- panel with embedded piping
- active surface of Renovis system
- thermal conductivity: 0,3 W/mK

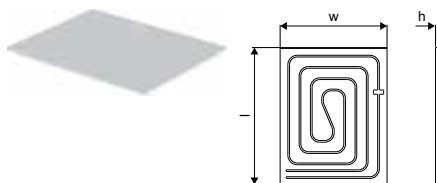

Item no.	Dimension	l mm	h mm	w mm	ND -	p bar	A m ²	R-value m ² K/W	colour -	Qty 1	UOM
1061173	800x625mm	800	15	625	15	6	0,5	3,000	RAL 7040	24	pce
1061172	1200x625mm	1200	15	625	15	6	0,75	3,000	RAL 7040	24	pce
1061171	2000x625mm	2000	15	625	15	6	1,25	3,000	RAL 7040	24	pce

Uponor Renovis

Uponor Renovis panel extra

- panel with embedded piping
- active surface of Renovis system
- thermal conductivity: 0,3 W/mK
- single packed panel

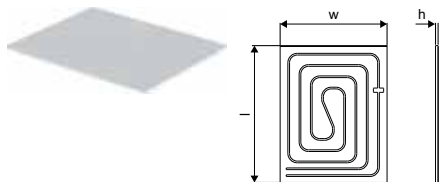

Item no.	Dimension	l mm	h mm	w mm	ND -	p bar	A m ²	R-value m ² K/W	colour -	Qty 2	Qty 1	UOM
1063923	800x625x15mm	800	15	625	15	6	0,5	3,000	RAL 7040	24	1	pce
1063924	1200x625x15mm	1200	15	625	15	6	0,75	3,000	RAL 7040	24	1	pce
1063925	2000x625x15mm	2000	15	625	15	6	1,25	3,000	RAL 7040	24	1	pce

Uponor Renovis panel passive

- panel with no piping
- for closing non-active surfaces of Renovis system
- thermal conductivity: 0,25 W/mK

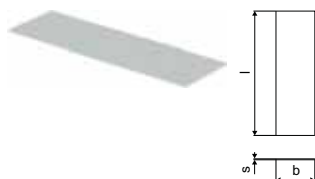

Item no.	Dimension	l mm	s mm	b mm	ND -	A m ²	R-value m ² K/W	colour -	Qty 1	UOM
1063926	2000x625x15mm	2000	15,0	625	15	1,25	3,000	RAL 7040	24	pce

Uponor Multi insulation for pipe 6mm

- Insulation made of Polyethylene for 9,9x1,1 mm pipe
- Density: 35Kg/m³.
- Thermal conductivity $\lambda=0.040$ W/mK.
- Water permeability $\mu= 6500$.



Item no.	Dimension	d mm	s mm	L m	Qty 1	UOM
1020475	10x6 10m	9,9	6,0	10	10	m

Uponor Q&E tee adapter S-Press



Item no.	Dimension	l1 mm	l2 mm	l3 mm	z1 mm	z2 mm	z3 mm	Qty 2	Qty 1	UOM
1063938	20-Q&E9,9-Press20	36	28	36	14	15	14	6	2	pce

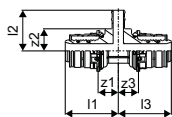

Uponor Renovis

Uponor Q&E adapter S-Press

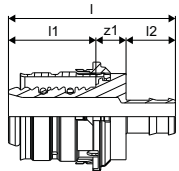

Item no.	Dimension	l	l1	l2	z1	Qty 2	Qty 1	UOM
		mm	mm	mm	mm			
1063939	20-Q&E9,9	43	22	13	8	12	2	pce

Uponor Siccus wall

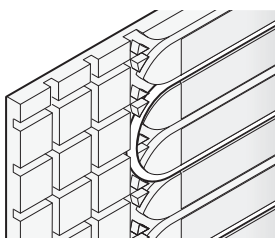

Siccus wall is the ideal solution for walls that are used for heating or cooling. It integrates smoothly with renovation and lightweight construction requirements.

Your benefits

- **Wall heating:** in addition or as alternative to floor radiant heating
- **Fast:** short installation time, high flexibility for lightweight constructions
- **Dry:** no drying time, no heat-up process necessary
- **Universal:** for use with Dim 14mm MLC or PE-Xa pipe



Specification

- Siccus wall heating panel system, consists of EPS (HBCD-free) boards acc. EN 13163 with Aluminium heat spreaders.
- EN 13501-1 fire classification: class E
- flame retardant class B1 acc. DIN 4102
- application type acc to DIN 4108-10: DEO dh, WI
- life load acc. EN 1991-1-1 = 7,5kN/m²
- for installations with pipe c-c 150mm
- for pipe dim 14mm

Application

- radiant wall heating and cooling
- for dry-build installations
- for sports floors

Certification

- DIN CERTCO: 7F008-F, 7F009-F, 7F332-F

Uponor Comfort Pipe PLUS

Specification

- Pipes manufactured from peroxide cross-linked polyethylene (PE-Xa) acc. EN ISO 15875
- EVOH (ethylene vinyl alcohol) layer for oxygen diffusion resistance as per DIN 4726
- 5layer
- Outside white PE layer designed to protect against mechanical damages
- Application class 4/5 - Underfloor heating and low temperature radiators
- Fire classification E according to DIN EN 13501-1.

Application

- Underfloor heating and low temperature radiators
- Heating
- Max design temperature: 90°C
- Malfunction temperature 100°C
- Design pressure 6 Bar at 70°C

Uponor Siccus wall

Uponor Siccus 14 panel

- installation panel with grooves
- EPS compressive strength: = 150 kPa
- R=0.622 m²K/W

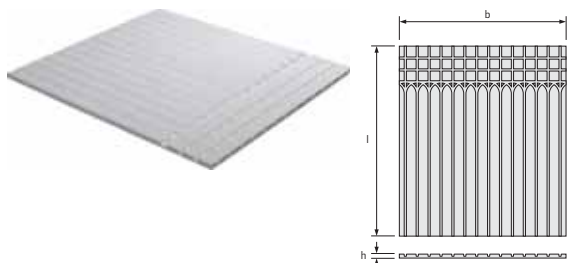

Item no.	Dimension	G kN/m ²	ND -	l mm	R-value m ² K/W	b mm	h mm	A m ²	Qty 2	Qty 1	UOM
1005485	EPS 150kPa 14mm 1197x1050x25mm	75	25	1197	0,622	1050	25	1,25	100	12,5	m ²

Uponor Siccus 14 heat emission plate

- aluminium heat spreader for use in Uponor dry UFH systems using pipe 14mm
- pre-cut equipped for easy size to measure
- material consumption = 5.6 pcs/m² (c-c150mm)

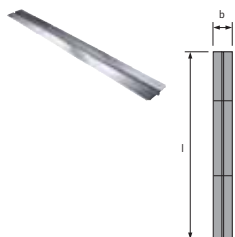

Item no.	Dimension	l mm	b mm	Qty 2	Qty 1	UOM
1005486	14mm 1180x120x0,45mm	1180	120	768	48	pce

Uponor Comfort Pipe PLUS

- 6/10 bar at 90°C/70°C

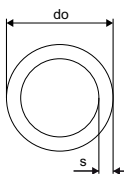

Item no.	Dimension	L m	do mm	s mm	p bar	colour	Qty 2	Qty 1	UOM
1062883	14x2,0 120m	120	14	2,0	6	white	1320	120	m
1062884	14x2,0 240m	240	14	2	6	white	1680	240	m
1062885	14x2,0 960m	960	14	2,0	6	white	1920	960	m

Uponor Siccus wall

Uponor Vario compression adapter PEX

- Eurocone
- Brass

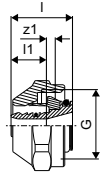

Item no.	Dimension	l	l1	G	z1	Qty 2	Qty 1	UOM
		mm	mm	inch	mm			
1065283	14x2,0-G3/4"FT Euro	23	13	3/4	3	25	1	pce

Uponor Fit compression adapter male PEX

- Brass

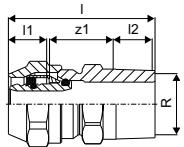

Item no.	Dimension	l	l1	l2	R	z1	Qty 2	Qty 1	UOM
		mm	mm	mm	inch	mm			
1065294	14x2,0-R1/2"MT	51	19	14	1/2	18	25	1	pce

Uponor Fit compression adapter female PEX

- Brass

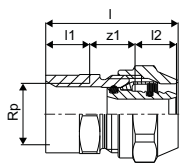

Item no.	Dimension	l	l1	l2	Rp	z1	Qty 2	Qty 1	UOM
		mm	mm	mm	inch	mm			
1065295	14x2,0-Rp1/2"FT	43	15	13	1/2	13	25	1	pce

Uponor Q&E coupling, rings DR

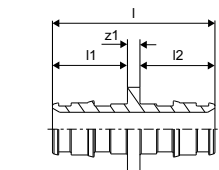

Item no.	Dimension	l	l1	l2	z1	Qty 2	Qty 1	UOM
		mm	mm	mm	mm			
1058659	14-14	39	18	18	3	100	10	pce

Uponor Siccus wall

Uponor Q&E ring natural, eval

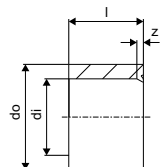

Item no.	Dimension	l mm	di mm	s mm	Qty 2	Qty 1	UOM
1058428	14	14	14,3	3,0	900	20	pce

Uponor Siccus 14 PS cutter, groove

- thermal cutting tool for EPS
- 230V, 50/60Hz
- with tool to cut grooves for 14mm pipes



Item no.	Dimension	OV V	Qty 2	Qty 1	UOM
1006290	14mm 230V	230	20	1	pce

Uponor Fix 14

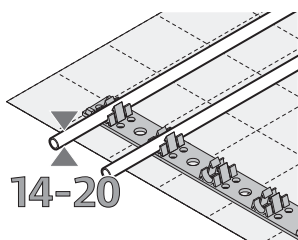

All components of the Uponor clamp track system are designed to perfectly match each other. The panels with thermal and step sound insulation are equipped with a tear-proof surface and printed

installation grid, enabling easy installation of system pipes. All components are designed to ensure optimum safety and reliable operation.

Your benefits

- Flexible pipe-laying: composite panels or rolls with different thermal and step sound insulation layers
- Large pipe coils: minimum cut-offs, twist-free installation
- Fast to install: integrated insulation layer and cover
- Universal for pipe dimensions of 14 – 20mm



Specification

- Fix system for pipe fixations in walls, ceiling and underfloor installations, consists of clamp tracks for pipe fixation.

Application

- radiant underfloor heating and cooling
- radiant wall and ceiling heating and cooling
- for use with cement- and anhydrite-based screeds

Certification

- DIN CERTCO: 7F277-W, 7F347-DW

Uponor Comfort Pipe PLUS

Specification

- Pipes manufactured from peroxide cross-linked polyethylene (PE-Xa) acc. EN ISO 15875
- EVOH (ethylene vinyl alcohol) layer for oxygen diffusion resistance as per DIN 4726
- 5layer
- Outside white PE layer designed to protect against mechanical damages
- Application class 4/5 - Underfloor heating and low temperature radiators
- Fire classification E according to DIN EN 13501-1.

Application

- Underfloor heating and low temperature radiators
- Heating
- Max design temperature: 90°C
- Malfunction temperature 100°C
- Design pressure 6 Bar at 70°C

Uponor Fix 14

Uponor MLC

Specification

- Oxygen diffusion resistant multi-layer composite pipe (PE-RT - adhesive - longitudinally welded aluminium - adhesive - PE-RT)
- Fire classification E according to EN 13501-1.
- With pipe end caps as hygienic seal according to EN 806.

Application

- Tap water: The permanent operating temperature ranges from 0°C to 70°C at a maximum permanent operating pressure of 10 bar. The short-term malfunction temperature is 95°C for a period of 100 hours in the operating life time.
- Heating: The permanent operating temperature ranges up to 80°C at a maximum permanent operating pressure of 10 bar. The short-term malfunction temperature is 100°C for a period of 100 hours in the operating life time.

Certification

- Approvals by local OM.
- E.g.
- DVGW
- AENOR

Uponor Fix clamp track U-profile

- clamp track for pipes 14mm
- c-c 50mm

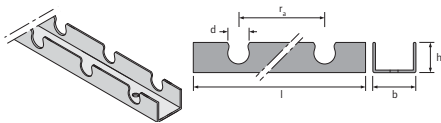

Item no.	Dimension	d	l	b	h	c/c	colour	Qty 1	UOM
		mm	mm	mm	mm	mm	-		
1005498	14mm c/c50mm 2,5m	14	2500	38	17	50	grey	25	m

Uponor Comfort Pipe PLUS

- 6/10 bar at 90°C/70°C

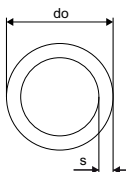

Item no.	Dimension	L	do	s	p	colour	Qty 2	Qty 1	UOM
		m	mm	mm	bar	-			
1062883	14x2,0 120m	120	14	2,0	6	white	1320	120	m
1062884	14x2,0 240m	240	14	2	6	white	1680	240	m
1062885	14x2,0 960m	960	14	2,0	6	white	1920	960	m

Uponor Fix 14

Uponor MLC pipe white

- coil

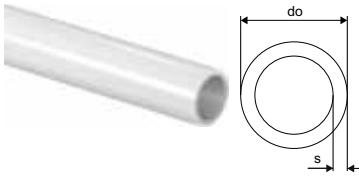

Item no.	Dimension	L m	do mm	s mm	Qty 2	Qty 1	UOM
1013366	14x2,0 200m	200	14	2	2600	200	m

Uponor Vario compression adapter PEX

- Eurocone

- Brass

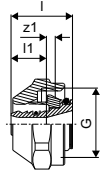

Item no.	Dimension	l mm	l1 mm	G inch	z1 mm	Qty 2	Qty 1	UOM
1065283	14x2,0-G3/4"FT Euro	23	13	3/4	3	25	1	pce

Uponor Fit compression adapter male PEX

- Brass

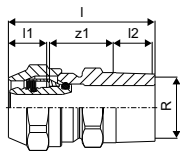

Item no.	Dimension	l mm	l1 mm	l2 mm	R inch	z1 mm	Qty 2	Qty 1	UOM
1065294	14x2,0-R1/2"MT	51	19	14	1/2	18	25	1	pce

Uponor Fit compression adapter female PEX

- Brass

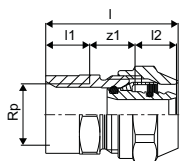

Item no.	Dimension	l mm	l1 mm	l2 mm	Rp inch	z1 mm	Qty 2	Qty 1	UOM
1065295	14x2,0-Rp1/2"FT	43	15	13	1/2	13	25	1	pce

Uponor Fix 14

Uponor Q&E coupling, rings DR

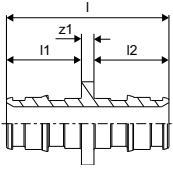

Item no.	Dimension	l mm	l1 mm	l2 mm	z1 mm	Qty 2	Qty 1	UOM
1058659	14-14	39	18	18	3	100	10	pce

Uponor Q&E ring natural, eval

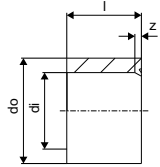

Item no.	Dimension	l mm	di mm	s mm	Qty 2	Qty 1	UOM
1058428	14	14	14,3	3,0	900	20	pce

Uponor Uni-X compression adapter MLC

- Compression adapter, union nut and inner sleeve
- made of brass
- For connection of Uponor Uni Pipe PLUS and MLC pipes to manifolds (eg. Uponor manifold H).
- Female thread 3/4" eurocone according to EN ISO 228-1

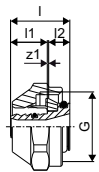

Item no.	Dimension	l mm	l1 mm	G inch	z1 mm	Qty 2	Qty 1	UOM
1058089	14-3/4"FT Euro	23	13	3/4	3	25	1	pce

Uponor Fix 14

Uponor S-Press coupling

Made of tin-plated brass

Contoured Aluminium-sleeve

Fast 3-step installation (press without bevel)

Colour code

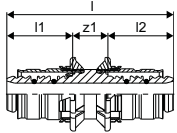

Item no.	Dimension	l	l1	l2	z1	Qty 2	Qty 1	UOM
		mm	mm	mm	mm			
1015154	14-14	54	21	21	11	80	10	pce

Uponor Q&E tee

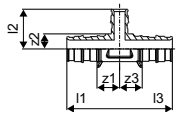

Item no.	Dimension	l	l1	l2	z1	z2	z3	Qty 2	Qty 1	UOM
		mm	mm	mm	mm	mm	mm			
1063932*	20-14-20	39	29	39	17	11	17	6	2	pce

Uponor Magna

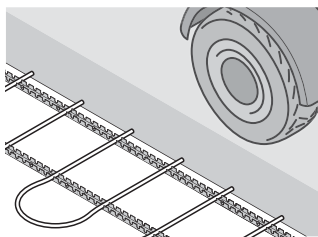

Uponor Magna is built directly into the basement concrete. The standard steel mats are used for pipe fixation. Any warm water heating system can be used.

Your benefits

- Easy and flexible: optimal use of space, few components
- Cost efficient: rapid return on investment, no maintenance costs
- Reliable: long-life, proven technology
- Comfortable: constant temperature, no dust



Specification

- Magna industrial heating system
- Loops 2-5 6-9 10-14 15-19 20
- Bracket 2 3 4 5 6
- Spacing outlet 100 mm

Application

- industrial and commercial large surface heating
- for use inside concrete
- max. 20 loops
- max. pressure: 6 bar at 60°C

Uponor Comfort Pipe PLUS

Specification

- Pipes manufactured from peroxide cross-linked polyethylene (PE-Xa) acc. EN ISO 15875
- EVOH (ethylene vinyl alcohol) layer for oxygen diffusion resistance as per DIN 4726
- 5layer
- Outside white PE layer designed to protect against mechanical damages
- Application class 4/5 - Underfloor heating and low temperature radiators
- Fire classification E according to DIN EN 13501-1.

Application

- Underfloor heating and low temperature radiators
- Heating
- Max design temperature: 90°C
- Malfunction temperature 100°C
- Design pressure 6 Bar at 70°C

Uponor Radi Pipe

Specification

- Pipes manufactured from peroxide cross-linked polyethylene (PE-Xa) acc. EN ISO 15875
- EVOH (ethylene vinyl alcohol) layer for oxygen diffusion resistance as per DIN 4726
- Application class 5 - high temperature radiators
- Fire classification E according to DIN EN 13501-1.

Application

- Heating: The permanent operating temperature ranges up to 90°C. The short-term malfunction temperature is 100°C for a period of 100 hours in the operating life time.

Uponor Magna

Uponor Multi clamp track U-profile

- clamp track for pipes 20 / 25mm
- c-c 50mm

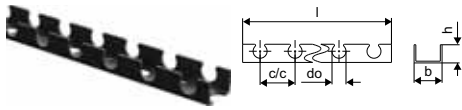

Item no.	Dimension	l mm	do mm	c/c mm	b mm	ND mm	colour	Qty 2	Qty 1	UOM
1005358	20mm c/c50mm	3m	3000	20	50	40	26 RAL 7042	30	3	m
1005290*	25mm c/c50mm	3m	3000	25	50	60		1320	30	m

Uponor Magna clamp track nail

- clamp track fixation clip
- for pipes 25 mm

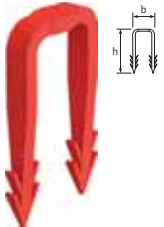

Item no.	Dimension	b mm	h mm	Qty 2	Qty 1	UOM
1005291*	25mm	36	50	5000	500	pce

Uponor Classic tying wire

- steel clip usable to fix pipe to steel mesh
- for use with Uponor tool for metallic clip



Item no.	Dimension	l mm	Qty 2	Qty 1	UOM
1009222	150x1,25mm	250pcs	150	250	1 pce

Uponor Comfort Pipe PLUS

- 6/8 bar at 90°C/70°C

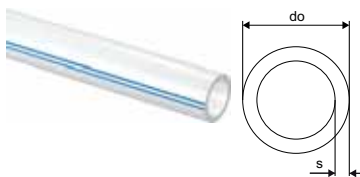

Item no.	Dimension	L m	do mm	s mm	p bar	colour	Qty 2	Qty 1	UOM
1009230	20x2,0	240m	240	20	2	6 white	960	240	m
1009231	20x2,0	480m	480	20	2	6 white	960	480	m

Uponor Magna

Uponor Comfort Pipe PLUS

- 6 bar at 90°C

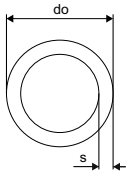

Item no.	Dimension	L m	do mm	s mm	p bar	colour	Qty 2	Qty 1	UOM
1062888	25x2,3	220m	220	25	2,3	6 white	440	220	m
1062889	25x2,3	300m	300	25	2,3	6 white	600	300	m
1063907	25x2,3	640m	640	25	2,3	6 white		640	m

Uponor Fit compression adapter male

- Brass

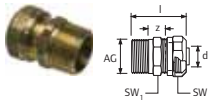

Item no.	Dimension	d mm	AG inch	I mm	SW mm	z mm	Qty 2	Qty 1	UOM
1005295	25x2,3-R3/4"MT	25	R 3/4	50	37/27	15	100	10	pce
1020064	25xR3/4"MT	25	3/4	50	37/27	15		2	pce
1005298	25x2,3-R1"MT	25	R 1	53	37/34	20	100	10	pce

Uponor Fit compression adapter female

- Brass

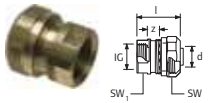

Item no.	Dimension	d mm	IG inch	I mm	SW mm	z mm	Qty 2	Qty 1	UOM
1005297	25x2,3-Rp3/4"FT	25	Rp 3/4	35	37/31	8	100	10	pce

Uponor Radi Pipe natural PN6 S

- Operating pressure 6 bar

- 6 m bars

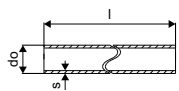

Item no.	Dimension	L m	do mm	s mm	p bar	colour	Qty 2	Qty 1	UOM
1008939	40x3,7	6m	6 40	3,7	6	natural	846	6	m

Uponor Magna expansion protective pipe

- made of PE-LD, for protection of UFH pipes 25mm in areas of expansion joints



Item no.	Dimension	Qty 2	Qty 1	UOM
1030631	34/28mm 25m	1250	25	m

Uponor Magna

Uponor Q&E adapter male thread PL

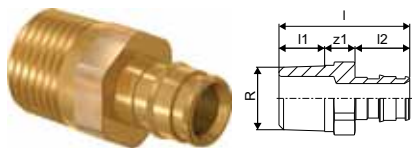

Item no.	Dimension	l	l1	l2	R	z1	p	Qty 2	Qty 1	UOM
		mm	mm	mm	inch	mm	bar			
1023007	25-R3/4"MT	55	17	27	1/2	11	6+10	70	5	pce
1023008	25-R1"MT	58	20	27	3/4	11	6+10	40	5	pce

Uponor Q&E adapter female thread PL



Item no.	Dimension	l	l1	l2	Rp	z1	p	Qty 2	Qty 1	UOM
		mm	mm	mm	inch	mm	bar			
1023012	25-Rp3/4"FT	51	18	27	3/4	6	6+10	40	5	pce
1023013	25-Rp1"FT	55	22	27	1	6	6+10	35	5	pce

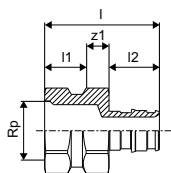

Uponor Magna manifold kit K1

- Includes: 2x brackets short, 2x brackets long, 2x filling valve brass, 2x thermometer 0 - 60°C, 1x manometer, 2x endcap, 2x flat sealing screw connection piece with swivel nut, 1x mounting material: 8x screws 6x60mm, 8x plastic anchor 8x40mm, 2x flat sealing 44x32x2

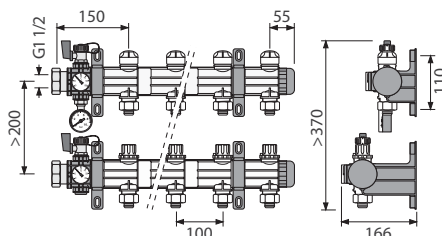

Item no.	Qty 2	Qty 1	UOM
1045815	1	1	pce

Uponor Magna manifold segment w. valve

- Supply-segment, with control valves for preadjustment, heating loop connection for G3/4 eurocone
 - Return-segment with thermostat upper section incl. cap for locking, Uponor actuator can be mounted directly on the return manifold, heating loop connection for G3/4 eurocone



Item no.	Dimension	p	VN	Qty 2	Qty 1	UOM
		bar	m³/h			
1045814	G3/4	6	8,0	10	1	pce

Uponor Magna

Uponor Magna manifold segment w. valve

- Supply-segment with control valves for preadjustment
- Return-segment with thermostat upper section incl. cap for locking
- Uponor actuator can be mounted directly on the return manifold
- Heating loop connection for PE-Xa Pipe 25x2,3 with compression adapter



Item no.	Dimension	p bar	VN m³/h	Qty 2	Qty 1	UOM
1045813	25	6	8,0	10	1	pce

Uponor Vario compression adapter PEX

- Eurocone
- Brass



Item no.	Dimension	l	l1	G	z1	Qty 2	Qty 1	UOM
		mm	mm	inch	mm			
1065290	20x1,9/2,0-G3/4"FT Euro	24	14	3/4	3	25	1	pce
1065291	25x2,3-G3/4"FT Euro	27	14	3/4	7	25	1	pce

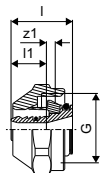

Uponor Magna ball valve, set

- Made of brass



Item no.	Dimension	Qty 2	Qty 1	UOM
1030135	2x G 1 1/2	1	1	pce

Uponor Magna manifold bracket kit

- Includes: 2x brackets short, 2x brackets long, 1x mounting material: 8x screws 6x60mm, 8x plastic anchor, 8x40mm



Item no.	Qty 2	Qty 1	UOM
1045816	1	1	pce

Uponor Magna manifold flowmeter

- With shut-off function
- Made of fibreglass reinforced Polyamid



Item no.	Qty 2	Qty 1	UOM
1030134	20	1	pce

Uponor Magna

Uponor Vario PLUS valve tool

- Tool for mounting and de-mounting the valves



Item no.	Qty 2	Qty 1	UOM
1009216	10	1	pce

Uponor Multi bend support plastic

- Impact resistant plastic
- Bend support 90°

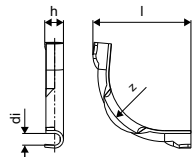

Item no.	Dimension	l mm	di mm	z mm	h mm	r mm	Qty 2	Qty 1	UOM
1001229	20	150	22	115	31	115	2300	50	pce
1001230	28	175	27	145	40	145	900	50	pce

Uponor Sport

Uponor Radi Pipe

Specification

- Pipes manufactured from peroxide cross-linked polyethylene (PE-Xa) acc. EN ISO 15875
- EVOH (ethylene vinyl alcohol) layer for oxygen diffusion resistance as per DIN 4726
- Application class 5 - high temperature radiators
- Fire classification E according to DIN EN 13501-1.

Application

- Heating: The permanent operating temperature ranges up to 90°C. The short-term malfunction temperature is 100°C for a period of 100 hours in the operating life time.

Uponor Sport pipe clip, plastic

- pipes fixation for sprung floors
- polyamide

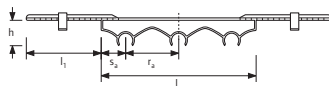

Item no.	Dimension	sa mm	l mm	l1 mm	h mm	c/c mm	colour	Qty 2	Qty 1	UOM
1005286*	25mm PA	45,00	290	145	50	100	red	150	25	pce

Uponor Sport double clip

- pipes fixation for sprung floors
- galvanized steel

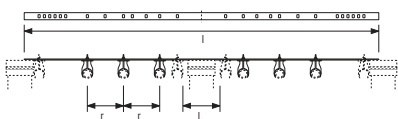
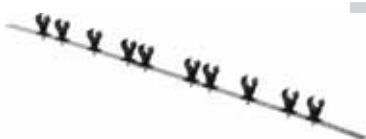

em no.	Dimension	l mm	l1 mm	c/c mm	Qty 2	Qty 1	UOM
005284*	25mm Steel	975	105	100	250	1	pce

Uponor Comfort Pipe PLUS

- 6 bar at 90°C

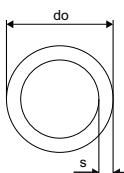

Item no.	Dimension	L m	do mm	s mm	p bar	colour	Qty 2	Qty 1	UOM
1062888	25x2,3 220m	220	25	2,3	6	white	440	220	m
1062889	25x2,3 300m	300	25	2,3	6	white	600	300	m
1063907	25x2,3 640m	640	25	2,3	6	white		640	m

Uponor Sport

Uponor Fit compression adapter male

- Brass

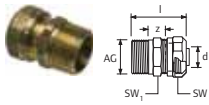

Item no.	Dimension	d mm	AG inch	l mm	SW mm	z mm	Qty 2	Qty 1	UOM
1005295	25x2,3-R3/4"MT	25	R 3/4	50	37/27	15	100	10	pce
1005298	25x2,3-R1"MT	25	R 1	53	37/34	20	100	10	pce

Uponor Fit compression adapter female

- Brass

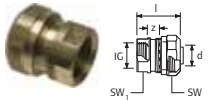

Item no.	Dimension	d mm	IG inch	l mm	SW mm	z mm	Qty 2	Qty 1	UOM
1005297	25x2,3-Rp3/4"FT	25	Rp 3/4	35	37/31	8	100	10	pce

Uponor Q&E coupling PPSU

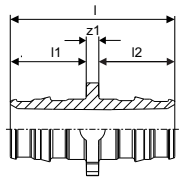

Item no.	Dimension	l mm	l1 mm	l2 mm	z1 mm	p bar	Qty 2	Qty 1	UOM
1008671	25-25	58	28	28	3	6+10	50	5	pce

Uponor Radi Pipe natural PN6 S

- Operating pressure 6 bar

- 6 m bars

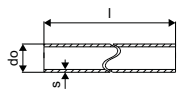

Item no.	Dimension	L m	do mm	s mm	p bar	colour	Qty 2	Qty 1	UOM
1008939	40x3,7 6m	6	40	3,7	6	natural	846	6	m

Uponor Q&E coupling PPSU

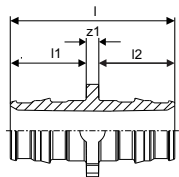

Item no.	Dimension	l mm	l1 mm	l2 mm	z1 mm	p bar	Qty 2	Qty 1	UOM
1008673	40-40	90	44	44	3	6+10	10	1	pce

Uponor Sport

Uponor Q&E elbow PPSU

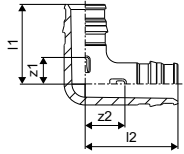

Item no.	Dimension	l1 mm	l2 mm	z1 mm	z2 mm	p mm bar	Qty 2	Qty 1	UOM
1008683	40-40	65	74	21	29	6+10	10	1	pce

Uponor Q&E adapter male thread PL W

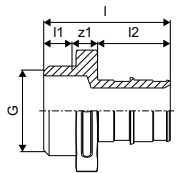

Item no.	Dimension	l mm	l1 mm	l2 mm	G inch	z1 mm	p mm bar	Qty 2	Qty 1	UOM
1008732	40-G1 1/4"MT	68	14	42	1 1/4	12	6+10	8	1	pce

Uponor Q&E adapter female thread PL

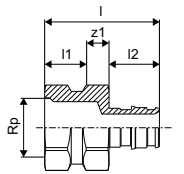

Item no.	Dimension	l mm	l1 mm	l2 mm	G inch	z1 mm	p mm bar	Qty 2	Qty 1	UOM
1047867	40-G1 1/4"FT	68	16	42	1 1/4	10	6+10	20	1	pce

Uponor Q&E ring with stop edge natural

- With stop edge
- Pex material

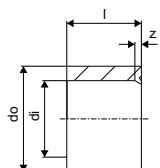

Item no.	Dimension	l mm	di mm	do mm	z mm	p mm bar	colour	Qty 2	Qty 1	UOM
1045464	40	41	40,8	50,2	3	6+10	natural	80	5	pce

Uponor Sport

Uponor Teck conduit

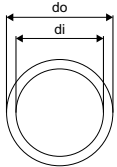

Item no.	Dimension	L m	di mm	do mm	colour	Qty 2	Qty 1	UOM
1012869	35/29 black 50m	50	29	35	black	1400	50	m

Uponor Sport tichelmann manifold Q&E

- 4 Q&E rings 25
- 2 Q&E rings 40

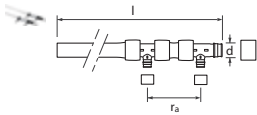

Item no.	Dimension	d mm	l mm	c/c mm	Qty 1	UOM
1046747	2X 25	40	2084	150	1	set

Uponor Sport tichelmann manifold Q&E

- 6 Q&E rings 25
- 2 Q&E rings 40

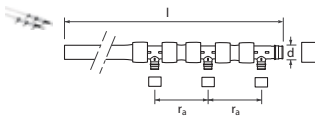

Item no.	Dimension	d mm	l mm	c/c mm	Qty 1	UOM
1046748	3X 25	40	2084	150	1	set

Uponor Sport tichelmann endsegment Q&E

- 6 Q&E rings 25

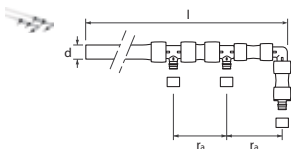

Item no.	Dimension	d mm	l mm	c/c mm	Qty 1	UOM
1046749	3X 25	40	2036	150	1	set

Uponor Multi bend support plastic

- Impact resistant plastic
- Bend support 90°

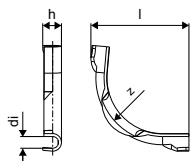

Item no.	Dimension	l mm	di mm	z mm	h mm	r mm	Qty 2	Qty 1	UOM
1001230	28	175	27	145	40	145	900	50	pce

Uponor Meltaway

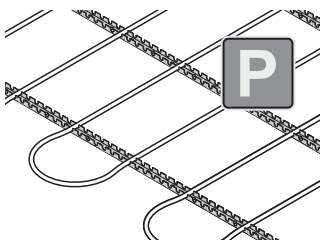

Uponor snow and ice melting system is ideal for all outdoor surfaces with a solid covering. It is especially designed for use with driveways, ramps, fire department or hospital approach roads, helicopter

landing zones, sidewalks, football pitches, etc.

Your benefits

- **Safe:** prevents injuries and accident liabilities
- **Year-round operation**
- **Efficient:** less maintenance costs, more security
- **Automatic de-icing:** no more shovelling of snow
- **Ecological:** avoids damage caused by de-icing salt



Specification

- snow- and ice melting system for areas with solid ground covering
- Made of high density polyethylene (HDPE) pipe
- Equipped with compact-welded couplings oriented in two directions with an angle of 120° between them

Application

- outdoor surface warming
- snow and ice melting

Uponor Magna clamp track U-profile

- clamp track for pipes 20 / 25mm
- c-c 50mm

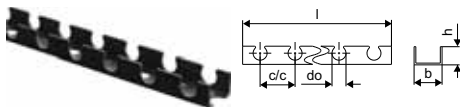

Item no.	Dimension	l mm	do mm	c/c1 mm	b mm	Qty 2	Qty 1	UOM
1005290*	25mm c/c50mm 3m	3000	25	50	60	1320	30	m

Uponor Magna clamp track nail

- clamp track fixation clip
- for pipes 25 mm

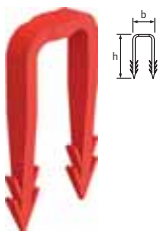

Item no.	Dimension	b mm	h mm	Qty 2	Qty 1	UOM
1005291*	25mm	36	50	5000	500	pce

Uponor Classic tying wire

- steel clip usable to fix pipe to steel mesh
- for use with Uponor tool for metallic clip



Item no.	Dimension	l mm	Qty 2	Qty 1	UOM
1009222	150x1,25mm 250pcs	150	250	1	pce

Uponor Meltaway

Uponor Meltaway PLUS PE-Xa orange

- PE-Xa
- Orange
- Snow melting and surface heating.
- Max design temperature: 50°C
- Design pressure: 4,5 Bar at 50°C

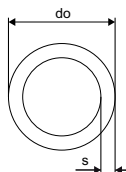

Item no.	Dimension	L m	do mm	s mm	Qty 2	Qty 1	UOM
1087526	25x2,3 640m	640	25	2,3	1	640	m
1087528	25x2,3 3000m	3000	25	2,3		3000	m

Uponor Meltaway PEX Pipe

- PE-Xb
- Snow melting and surface heating.
- Max design temperature: 50°C
- Design pressure: 4,5 Bar at 50°C

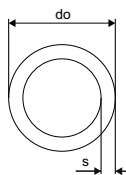

Item no.	Dimension	L m	do mm	s mm	p bar	colour	Qty 1	UOM
1033625	25x2,3 1020m	1020	25	2,3	4,5	orange	1020	m
1033626	25x2,3 custom made	1	25	2,3	4,5	orange	1020	m

Note: Ask delivery time for the custom-made items

Uponor Fit compression adapter male

- Brass

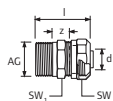

Item no.	Dimension	d mm	AG inch	l mm	SW mm	z mm	Qty 2	Qty 1	UOM
1005295	25x2,3-R3/4"MT	25	R 3/4	50	37/27	15	100	10	pce
1005298	25x2,3-R1"MT	25	R 1	53	37/34	20	100	10	pce

Uponor Fit compression adapter female

- Brass

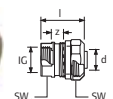

Item no.	Dimension	d mm	IG inch	l mm	SW mm	z mm	Qty 2	Qty 1	UOM
1005297	25x2,3-Rp3/4"FT	25	Rp 3/4	35	37/31	8	100	10	pce

Uponor Meltaway

Uponor Meltaway single manifold

- Single manifold



Item no.	Dimension	outlets -	d mm	c/c mm	Qty 1	UOM
1033639*	160 1x10 c/c600 6m	10	160	600	1	pce
1033640	75 1x40 c/c150 6m	40	75	150	1	pce
1033645	110 1x40 c/c150 6m	40	110	150	1	pce
1033631	75mm 1x12 c/c500 6m	12	75	500	1	pce
1033632	110 1x12 c/c500 6m	12	110	500	1	pce
1033633	160 1x12 c/c500 6m	12	160	500	1	pce

Uponor Meltaway double manifold

- Double manifold



Item no.	Dimension	outlets -	d mm	c/c mm	Qty 1	UOM
1033634	75 2x12 c/c500 6m	24	75	500	1	pce

Uponor Meltaway coupling



Item no.	Dimension	d mm	s mm	Qty 1	UOM
1033672	25x2,3 145mm	25	2,3	1	pce
1033678	25x2,3 290mm	25	2,3	1	pce

Uponor Meltaway feeder tubes

- Made of HDPE



Item no.	Dimension	L m	do mm	s mm	Qty 1	UOM
1033628	75x6,8 6m	6	75	6,8	6	m
1033629	110x6,8 6m	6	110	6,6	6	m

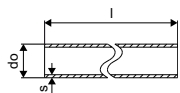

Uponor Meltaway

Uponor Multi bend support plastic

- Impact resistant plastic
- Bend support 90°

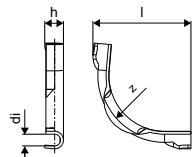

Item no.	Dimension	l mm	di mm	z mm	h mm	r mm	Qty 2	Qty 1	UOM
1001230	28	175	27	145	40	145	900	50	pce

Uponor Teck conduit

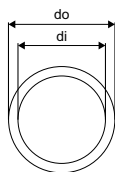

Item no.	Dimension	L m	di mm	do mm	colour	Qty 2	Qty 1	UOM
1012869	35/29 black 50m	50	29	35	black	1400	50	m

Uponor Fix 9,9

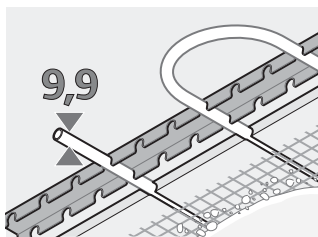

Uponor radiant heating and cooling system for ceiling and wall installation. Consists of 9.9mm PE-Xa pipes integrated into plaster covering of ceiling and walls. Due to the minimal thickness of the plaster covering the

system has very short reaction times and adjusts quickly to any condition changes.

Your benefits

- **Universal:** one system for ceiling and wall mounting
- **Simple:** few, optimally matched components
- **Comfort:** short heat-up times, quickly adjustable
- **Energy saving:** low operating temperatures



Uponor Comfort Pipe

Specification

- Pipes manufactured from peroxide cross-linked polyethylene (PE-Xa) acc. EN ISO 15875
- EVOH (ethylene vinyl alcohol) layer for oxygen diffusion resistance as per DIN 4726
- Application class 4 - Underfloor heating and low temperature radiators
- Fire classification E according to DIN EN 13501-1.

Application

- Underfloor heating and low temperature radiators
- Max design temperature: 90°C
- Malfunction temperature 100°C
- Design pressure 6 Bar at 70°C

Uponor Comfort Pipe PLUS

Specification

- Pipes manufactured from peroxide cross-linked polyethylene (PE-Xa) acc. EN ISO 15875
- EVOH (ethylene vinyl alcohol) layer for oxygen diffusion resistance as per DIN 4726
- 5layer
- Outside white PE layer designed to protect against mechanical damages
- Application class 4/5 - Underfloor heating and low temperature radiators
- Fire classification E according to DIN EN 13501-1.

Application

- Underfloor heating and low temperature radiators
- Heating
- Max design temperature: 90°C
- Malfunction temperature 100°C
- Design pressure 6 Bar at 70°C

Uponor Fix 9,9

Uponor Fix clamp track

- clamp track for pipe 9.9mm
- c-c 20mm

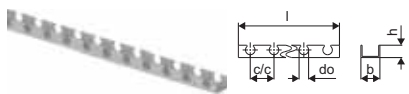

Item no.	Dimension	l mm	do mm	c/c1 mm	b mm	colour	Qty 2	Qty 1	UOM
1005274	9,9mm c/c20mm 2,5m	2500	10	20	24	grey	25	2,5	m

Uponor Multi bend support plastic

- Impact resistant plastic
- Bend support 90°



Item no.	Dimension	l mm	di mm	c/c mm	z mm	h mm	r mm	Qty 2	Qty 1	UOM
1063781	12	73	10	30	65	18	65	500	50	pce

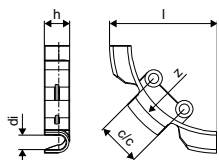

Uponor Minitec Comfort Pipe

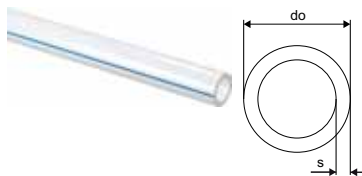

Item no.	Dimension	L m	do mm	s mm	p bar	colour	Qty 2	Qty 1	UOM
1063288	9,9x1,1 120m	120	9,9	1,1	6	natural	1680	120	m
1063289	9,9x1,1 240m	240	9,9	1,1	6	natural	2640	240	m
1063381	9,9x1,1 480m	480	9,9	1,1	6	natural	2880	480	m

Uponor Minitec ring natural

- PE-Xa



Item no.	Dimension	l mm	di mm	do mm	p bar	Qty 2	Qty 1	UOM
1005263	9,9x1,1	15	10,3	13,9	6	1600	10	pce

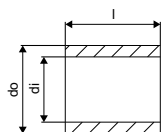

Uponor Fix 9,9

Uponor Vario adapter Minitec

- Eurocone
- Brass



Item no.	Dimension	l	l1	G	z1	Qty 2	Qty 1	UOM
		mm	mm	inch	mm			
1005266	9,9x1,1-G3/4"Euro	35	14	3/4	14	100	10	pce

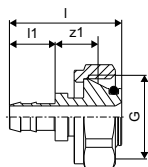

Uponor Minitec coupling, rings

- Q&E
- Brass
- With Q&E rings



Item no.	Dimension	l	l1	l2	z1	p	Qty 2	Qty 1	UOM
		mm	mm	mm	mm	bar			
1005264	9,9x1,1	33	14	14	4	6	100	10	pce

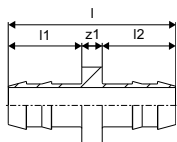

Uponor Minitec tee reduced, rings Q&E

- Q&E
- Brass
- With Q&E rings



Item no.	Dimension	l1	l2	l3	z1	z2	z3	Qty 2	Qty 1	UOM
		mm	mm	mm	mm	mm	mm			
1020524	20xMinitec9,9xQ&E20	36	25	36	14	12	14	75	5	pce

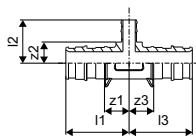

Uponor Minitec adapter male thread, ring

- Q&E
- Brass
- With Q&E ring



Item no.	Dimension	l	l1	l2	R	z1	p	Qty 2	Qty 1	UOM
		mm	mm	mm	inch	mm	bar			
1005265	9,9-R1/2"MT	38	16	14	1/2	8	6	100	10	pce

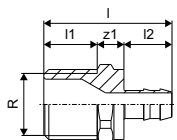

Uponor Fix 9,9

Uponor Comfort Pipe PLUS

- 6/8 bar at 90°C/70°C

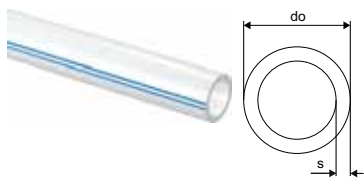

Item no.	Dimension	L m	do mm	s mm	p bar	colour	Qty 2	Qty 1	UOM
1009228	20x2,0	120m	120	20	2	6 white	840	120	m
1009230	20x2,0	240m	240	20	2	6 white	960	240	m
1009231	20x2,0	480m	480	20	2	6 white	960	480	m

Uponor Minitec reducer, rings Q&E

- Q&E
- Brass
- With Q&E rings



Item no.	Dimension	l mm	l1 mm	l2 mm	z1 mm	Qty 2	Qty 1	UOM
1020518	20xMinitec9,9	38	22	13	3	150	5	pce

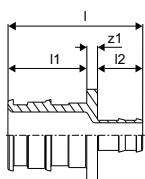

Uponor Vario compression adapter PEX

- Eurocone
- Brass



Item no.	Dimension	l mm	l1 mm	G inch	z1 mm	Qty 2	Qty 1	UOM
1065290	20x1,9/2,0-G3/4"FT Euro	24	14	3/4	3	25	1	pce

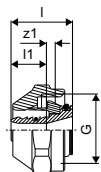

Uponor Q&E expansion head M12/M18



Item no.	Dimension	d mm	s mm	p bar	stroke mm	Qty 1	UOM
1057173	20x1,9/2,0	20	1,9/2,0	6	14/25	1	pce

Uponor Fix 9,9

Uponor Q&E expansion tool with heads M12



Item no.	Dimension	p bar	stroke mm	Qty 1	UOM
1063112	6BAR 9,9/20	6	14	1	set

Uponor Q&E head M12



Item no.	Dimension	stroke mm	Qty 1	UOM
1060702	9,9x1,1	14	1	pce

Uponor Thermatop M

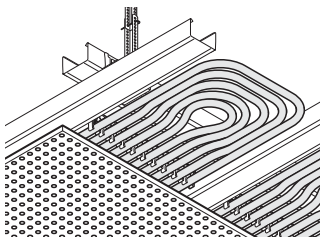

CD profiles of the ceiling substructure.

Uponor Thermatop M is a water-based radiant heating and cooling ceiling system for integration into seamless plasterboard ceilings. Quick and tool-free installation of the standardized prefab emitters by clicking into the

Your benefits

- Seamless and directionless ceiling surfaces for special architectural requirements
- High heating and cooling capacities thanks to large, thermally-active pipe surface and good contact with gypsum board
- Clear separation of trades between drywall construction and building technology
- Ideally suited for renewable energy sources
- 100% diffusion resistance
- No draughts and no noise



Specification

- Emitter made of 16 x 2,0 mm Uni Pipe PLUS with 10 pipe rows and up to 37,3 m per m² module.
- The pipe is 100% diffusion-resistant according to DIN 4726.
- Cooling capacity according to EN 14240 (8K) up to 67 W/m²
- Heating capacity according to EN 14037 (15K) up to 105 W/m².
- Sound absorption according to DIN EN ISO 354 with α_w between 0,60 to 0,65.
- Capacity and acoustic values depending on gypsum board.

Application

- Radiant ceiling emitter for mounting on gypsum board sub-construction CD-profile (CD 27/60) with a axial spacing of 333 mm.

Uponor Thermatop M

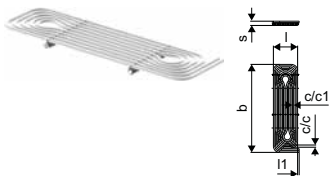

Item no.	Dimension	l mm	l1 mm	s mm	c/c mm	c/c1 mm	b mm	Area	QC W/m ²	QH W/m ²	Qty 2	Qty 1	UOM
1090933	950x277mm	277	17	47,0	24	28	950	0,26	65	103	200	10	pce
1090934	1350X277mm	277	17	47	24	28	1350	0,37	65	103	200	10	pce
1090935	1750X277mm	277	17	47	24	28	1750	0,48	65	103	200	10	pce
1090936	2150X277mm	277	17	47	24	28	2150	0,60	65	103	200	10	pce
1090937	2550x277mm	277	17	47	24	28	2550	0,71	65	103	200	10	pce

Uponor Multi

Uponor Multi

Specification

- UFH installation accessories and components for multiple systems

Application

- radiant heating and cooling systems

Uponor Multi cable ties PA

- cable ties for pipe fixation

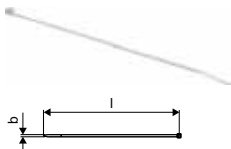

Item no.	Dimension	l mm	b mm	colour	Qty 2	Qty 1	UOM
1005372	280mm	300	7	-	5000	100	pce

Uponor Multi clamp track U-profile

- clamp track for pipes 20 / 25mm

- c-c 50mm

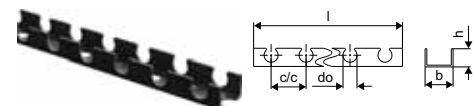

Item no.	Dimension	l mm	do mm	c/c1 mm	b mm	ND	colour	Qty 2	Qty 1	UOM
1005358	20mm c/c50mm 3m	3000	20	50	40	26	RAL 7042	30	3	m

Uponor Multi foil PE

- PE-foil for installation on top of existing thermal insulation

- transparent

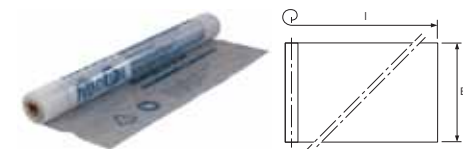

Item no.	Dimension	s mm	ND	L m	B m	A m ²	colour	Qty 2	Qty 1	UOM
1005049	0,2mm 60x1,25m	0,2	0,2	60	1,25	75	transparent	3375	75	m ²

Uponor Multi foil

- PE-foil for installation on top of existing thermal insulation

- transparent

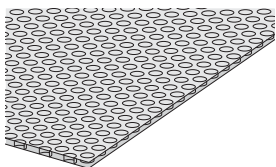

Item no.	Dimension	s mm	G kN/m ²	ND	L m	B m	A m ²	Qty 1	UOM
1000017	4mm 60x1m	4,0	15	4	60	1	60	60	m ²

Uponor Multi

Uponor Multi texture foil with raster

- PE-foil for installation on top of existing thermal insulation
- recommended for Uponor Fix clamp track installations
- grey colour
- with printed pattern 100x100 mm

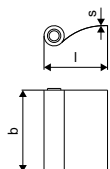

Item no.	Dimension	Area	A	colour	Qty 2	Qty 1	UOM
1000015	0,25mm 100x1,03m	103	100	grey	2472	103	m ²

Uponor Multi foil nail

- fixation of foil to insulation boards

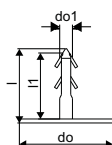

Item no.	Dimension	l	l1	do	do1	colour	Qty 2	Qty 1	UOM
1000016	l=25mm	28	25	35	4,8	red	5000	100	pce

Uponor Multi PE edging strip with foil

- edging strip, conforming to DIN 18560, made of polyethylene with self-adhesive backing, self-adhesive strip on outer face provides tight seal between edging strip and insulation

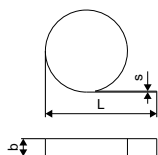

Item no.	Dimension	l	L	s	b	colour	Qty 1	UOM
1000080	150x10mm	50000	50	10	150	blue	200	m

Uponor Multi PE edging strip with foil

- edging strip, conforming to DIN 18560, made of polyethylene, self-adhesive strip on outer face provides tight seal between edging strip and insulation

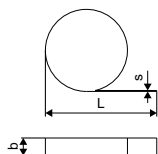

Item no.	Dimension	L	s	b	colour	Qty 1	UOM
1000079	150x8mm	50	8	150	blue	200	m

Uponor Multi

Uponor Multi joint profile PP

- self-adhesive profile of polyethylene foam expansion strip and hard-PVC body, for separation of screed sections (e.g. in doorways), and to absorb expansion of screed
- for expansion joints as per DIN 18560-2



Item no.	Dimension	s mm	L m	h mm	Qty 2	Qty 1	UOM
1090229	1800x100x10mm	10,0	1,8	100	720	18	m

Uponor Multi joint protection tube

- Made of PE-LD, with slit opening, for protection of UFH pipes up to 20mm in areas of expansion joints.



Item no.	Dimension	s mm	l mm	b mm	Qty 2	Qty 1	UOM
1000082	20mm 300x5mm	5,0	300	80	10800	30	pce

Uponor Multi screed additive VD 450

- screed additive; improves screed quality
- for use with cementitious screed only
- enhances plastification and water retention
- Material consumption for 7 cm screed thickness: 0.2 l/m²
- Minimum screed covering: 30 mm at 2 kN/m² or 45 mm at 5 kN/m² if installed with Uponor insulation/system board for 5 kN/m²
- Curing time: 21 days



Item no.	Dimension	Vol. l	DT d	Qty 2	Qty 1	UOM
1000084	20L	20,00	21	480	20	l

Uponor Multi screed additive, fast dry VD 550

- screed additive; improves screed quality
- improves fast drying and early hardening
- for use with cementitious screed only
- Material consumption for 7 cm screed thickness: 0.2 l/m²
- Minimum screed covering: 30 mm at 2 kN/m² or 45 mm at 5 kN/m² if installed with Uponor insulation/system board for 5 kN/m²
- Curing time: 8 days



Item no.	Dimension	Vol. l	DT d	Qty 2	Qty 1	UOM
1000085	25L	25,00	8	600	25	l

Uponor Multi

Uponor Multi marking set

- markers for dampness measuring point in screeds
- 1pc per room
- self-adhesive, re mark

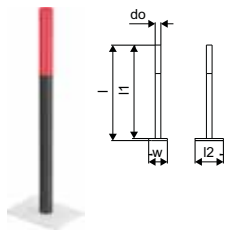

Item no.	Dimension	l mm	l1 mm	l2 mm	do mm	w mm	Qty 1	UOM
1000083	100mm	102	100	30	6,1	20	10	pce

Uponor Multi anti-freeze agent ethylen

- ethylene glycol-based anti-freeze agent, for use as additive in radiant heating systems with Uponor pipes



Item no.	Dimension	Vol. l	Qty 2	Qty 1	UOM
1005066	>= -30°C 20l	20,00	480	20	l

Uponor Q&E Supply = 20

Uponor Q&E tee

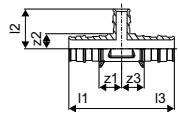

Item no.	Dimension	l	l1	l2	z1	z2	z3	Qty 2	Qty 1	UOM
		mm	mm	mm	mm	mm	mm			
1063932	20-14-20	39	29	39	17	11	17	6	2	pce

Uponor Q&E reducer

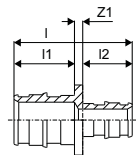

Item no.	Dimension	l	l1	l2	z1	Qty 2	Qty 1	UOM
		mm	mm	mm	mm			
1063933	20-14	43	22	18	3	12	2	pce

Uponor Vario PLUS

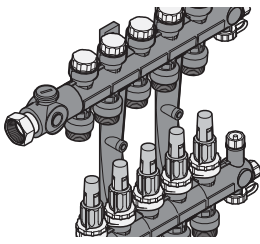

Uponor Vario PLUS is a high quality manifold made of glass fiber reinforced polyamide. It is created for underfloor heating and cooling applications for easy installation and highest reliability.

It is deliverable in flexible modules of 1, 3, 4 and 6 loops and corresponding fill/drain/ventilation sets or primary connection sets.

The secondary connectors allow the connection of all Uponor pipe dimensions which makes the manifold universal for Uponor underfloor heating and cooling systems.

Your benefits

- Modular manifold segments 1, 3, 4 and 6 loops available for assembling of flexible size of manifold circuits
- Also suitable for large heating / cooling surfaces in residential and commercial areas
- Compact installation combined with pump groups, Uponor control units and heat meter connection sets in Uponor cabinets
- Optional available with or without flow indicator



Specification

- Modular fibre glass reinforced polyamide manifold with 1,3,4,6 loops for connection with basic kit
- connection right or left with flat sealing or connection from below with optional elbowset
- supply with lockshield (LS) valve for balancing with adjusting ring or supply with Flowmeter (FM) for balancing
- shut-off and flow view
- adjusting ring for balancing without tools
- prepared places for room name labels
- return with valves and caps, prepared for actuators
- loop connection G3/4" eurocone
- loop pitch 50 mm
- header pitch 225 mm

Actuator:

- NC (normally closed) = closes without power

Application

- for underfloor heating and cooling
- combineable with actuators No. 1090262 (24V male) No. 1090263 (230V male)

Certification

- CE

Uponor Vario PLUS manifold w. valve

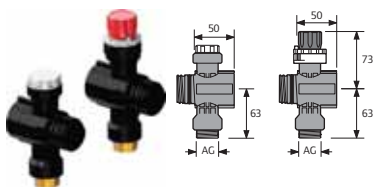

Item no.	Dimension	outlets	p	l	Qty 2	Qty 1	UOM
		-	bar	mm			
1042420*	LS 1X 3/4 Euro	1	6	50	10	1	pair
1030580*	LS 3X 3/4 Euro	3	6	150	290	1	pair
1030581*	LS 4X 3/4 Euro	4	6	200	225	1	pair
1030582*	LS 6X 3/4 Euro	6	6	300	155	1	pair

Uponor Vario PLUS

Uponor Vario PLUS manifold flowmeter



Item no.	Dimension	outlets	p	l	Qty 2	Qty 1	UOM
		-	bar	mm			
1042471*	FM 1X 3/4 Euro	1	6	50	10	1	pair
1030583*	FM 3X 3/4 Euro	3	6	150	174	1	pair
1030584*	FM 4X 3/4 Euro	4	6	200	135	1	pair
1030585*	FM 6X 3/4 Euro	6	6	300	93	1	pair

Uponor Vario compression adapter PEX

- Eurocone
- Brass

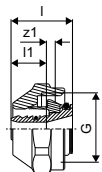

Item no.	Dimension	l	l1	G	z1	Qty 2	Qty 1	UOM
		mm	mm	inch	mm			
1065283	14x2,0-G3/4"FT Euro	23	13	3/4	3	25	1	pce
1065284	16x1,8/2,0-G3/4"FT Euro	23	13	3/4	3	25	1	pce
1065286	17x2,0-G3/4"FT Euro	23	13	3/4	3	25	1	pce
1065290	20x1,9/2,0-G3/4"FT Euro	24	14	3/4	3	25	1	pce

Uponor Vario PLUS manifold kit

- Including brackets, flat sealing screw connection pieces with swivel nut, thermometer and end pieces with air vent, filling and draining tap and a by-pass



Item no.	Dimension	l	Qty 2	Qty 1	UOM
		mm			
1009209*	K1	150	248	1	pce

Uponor Vario PLUS manifold kit

- Including brackets, flat sealing screw connection pieces with swivel nut, thermometer, end pieces with air trap, filling and draining tap



Item no.	Dimension	Qty 2	Qty 1	UOM
1046882	K2	186	1	set

Uponor Vario PLUS

Uponor Vario PLUS actuator NC

- open/closed indicator
- operation at ambient temperature of up to +60°C
- protection class: IP54



	Item no.	Dimension	d mm	AG mm	OV V	P W	h mm	Qty 2	Qty 1	UOM
NEW	1000138	24V MT30x1,5	40	30x1,5	24	~2	54	10	1	pce
NEW	1005605	230V MT30x1,5	40	30x1,5	230	~2	54	10	1	pce

Uponor Vario PLUS insulation kit

- Insulation thickness 19 mm, 0,038 W/mK
- Length 665 mm
- Fire classification BL-s3,do (EN 13501-1)



Item no.	Qty 1	UOM
1063207	1	set

Uponor Vario PLUS elbow connection



Item no.	Dimension	AG inch	Qty 2	Qty 1	UOM
1032702*	122/42	1	5	1	pair

Uponor Vario PLUS overflow valve

- Adjustable difference pressure regulation



Item no.	Dimension	Qty 2	Qty 1	UOM
1046884	225mm	640	1	pce

Uponor Vario PLUS

Uponor Vario PLUS distance set

- Manifold single segments for mixed loop connection from top and bottom

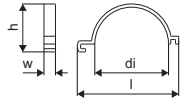

Item no.	l mm	h mm	w1 mm	Qty 2	Qty 1	UOM
1009215*	220	104	25	10	1	pce

Uponor Vario PLUS hose connection

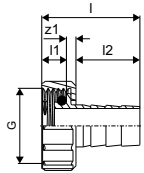

Item no.	Dimension	l mm	l1 mm	l2 mm	z1 mm	Qty 2	Qty 1	UOM
1009214	G3/4 x 1/2	35	9	23	3	10	1	pce

Uponor Vario PLUS flowmeter

- With shut-off function



Item no.	Dimension	Qty 2	Qty 1	UOM
1009217*	4 l/min	20	1	pce

Uponor Vario PLUS valve tool

- Tool for mounting and de-mounting the valves



Item no.	Qty 2	Qty 1	UOM
1009216	10	1	pce

Uponor Vario M

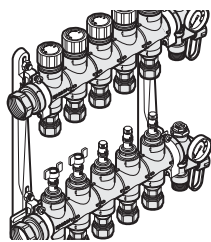

Uponor Vario M is a high quality manifold made of glass fiber reinforced polyamide. It is created for underfloor heating and cooling applications for easy installation and highest reliability.

The secondary G 3/4 euro cone connectors allow the connection of all Uponor pipe dimensions which makes the manifold universal for Uponor underfloor heating and cooling systems.

Your benefits

- Ready to install - pre-assembled bars with 2-15 circuits
- Easy to mount - flow and return 1/2 port offset against each other
- Flow indicators resistant against contamination, with interchangeable glass inserts
- Also suitable for large heating/cooling surfaces in residential and commercial areas
- Compact installation combined with pump groups, Uponor control units and heat meter connection sets in Uponor cabinets



Specification

- Made of fibre glass reinforced polyamid
- With integrated valves
- Connection right or left G1 with flat sealing
- Supply bar with flowmeter for balancing and shut-off
- Return bar with return valves and caps
- Integrated airvents and fill&drain points in supply and return
- Loop connection: G3/4" eurocone
- Loop pitch: 50 mm

Application

- For underfloor heating and cooling
- Max. pressure: 6 bar at 60°C
- Combineable with actuators No. 1087778 (24V) No. 1087763 (230 V)

Uponor Vario M manifold with flowmeter FM



Item no.	Dimension	outlets	p	l	Qty 2	Qty 1	UOM
		-	bar	mm			
1085944	2X G3/4 Euro	2	6	210	80	1	pce
1085945	3X G3/4 Euro	3	6	260	80	1	pce
1085946	4X G3/4 Euro	4	6	310	80	1	pce
1085947	5X G3/4 Euro	5	6	360	80	1	pce
1085948	6X G3/4 Euro	6	6	410	80	1	pce
1085949	7X G3/4 Euro	7	6	460	80	1	pce
1085950	8X G3/4 Euro	8	6	510	80	1	pce
1085951	9X G3/4 Euro	9	6	560	80	1	pce
1085952	10X G3/4 Euro	10	6	610	80	1	pce
1086250	11X G3/4 Euro	11	6	700	108	1	pce
1086251	12X G3/4 Euro	12	6	750	108	1	pce
1087129	13X G3/4 Euro	13	6	800	30	1	pce
1087130	14X G3/4 Euro	14	6	850	30	1	pce
1087131	15X G3/4 Euro	15	6	900	30	1	pce

Uponor Vario M

Uponor Vario M bracket set



Item no.	Qty 1	UOM
1087531	1	set

Uponor Vario M flowmeter

- With shut-off function



Item no.	Dimension	Qty 1	UOM
1085956*	0-5l/min	1	pce

Uponor Vario S

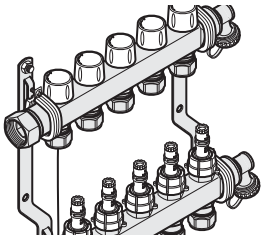

Uponor Vario S is a stainless steel manifold for underfloor heating in residential applications that provides easy installation with high reliability.

The secondary G 3/4 euro cone connectors allow the

connection of all Uponor pipe dimensions which makes the manifold universal for Uponor underfloor heating and cooling systems.

Your benefits

- Ready to install – pre-assembled bars with 2-16 heating circuits
- Also suitable for large heating surfaces in residential and commercial areas
- Compact installation combined with pump groups, Uponor control units and heat meter connection sets in Uponor cabinets
- Optional available with or without flow indicator



Specification

- Made of stainless steel
- With integrated valves
- Connection right or left with flat sealing supply
- Integrated airvents and fill&drain points in supply and return
- Loop connection G3/4" eurocone
- Loop pitch 50 mm

Application

- For underfloor heating and cooling
- Combineable with actuators 1087763 (230V) or 1077778 (24V)
- Max. pressure: 6 bar at 60°C

Uponor Vario S manifold FM

- Supply with flow meter for balancing and shutoff
- Return with valves and caps

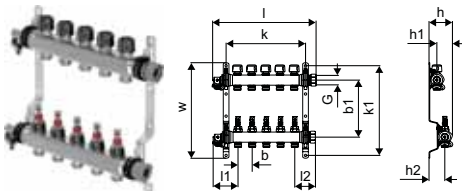

Item no.	Dimension	outlets	l	l1	l2	G	G1	b	b1	h	h1	h2	k	k1	w	p	Qty 2	Qty 1	UOM	
-	-	-	mm	mm	mm	inch	inch	mm	mm	mm	mm	mm	mm	mm	mm	mm	bar			
1086538	2X3/4 Euro	2	210	87	73	1	3/4	50	215	75	30	50	135	336	357	6	108	1	pce	
1086539	3x3/4 Euro	3	260	87	73	1	3/4	50	215	75	30	50	185	336	357	6	108	1	pce	
1086540	4x3/4 Euro	4	310	87	73	1	3/4	50	215	75	30	50	235	336	357	6	108	1	pce	
1086541	5x3/4 Euro	5	360	87	73	1	3/4	50	215	75	30	50	285	336	357	6	108	1	pce	
1086542	6x3/4 Euro	6	410	87	73	1	3/4	50	215	75	30	50	335	336	357	6	72	1	pce	
1086543	7X3/4 Euro	7	460	87	73	1	3/4	50	215	75	30	50	385	336	357	6	72	1	pce	
1086544	8x3/4 Euro	8	510	87	73	1	3/4	50	215	75	30	50	435	336	357	6	72	1	pce	
1086545	9x3/4 Euro	9	560	87	73	1	3/4	50	215	75	30	50	485	336	357	6	72	1	pce	
1086546	10x3/4 Euro	10	610	87	73	1	3/4	50	215	75	30	50	535	336	357	6	48	1	pce	
1086547	11x3/4 Euro	11	660	87	73	1	3/4	50	215	75	30	50	585	336	357	6	48	1	pce	
1086548	12x3/4 Euro	12	710	87	73	1	3/4	50	215	75	30	50	635	336	357	6	48	1	pce	
1088864	13x3/4 Euro	13	760	87	73	1	3/4	50	215	75	30	50	780	336	357	6	48	1	pce	
1088865	14X3/4 Euro	14	810	87	73	1	3/4	50	215	75	30	50	830	336	357	6	36	1	pce	
1088866	15x3/4 Euro	15	860	87	73	1	3/4	50	215	75	30	50	880	336	357	6	36	1	pce	
1088867	16x3/4 Euro	16	910	87	73	1	3/4	50	215	75	30	50	930	336	357	6	36	1	pce	

Uponor Vario S

Uponor Vario S manifold LS

- Supply with lock shield valves for shutoff
- Return with valves for balancing and caps

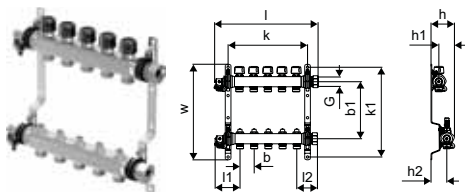

Item no.	Dimension	outlets	l	l1	l2	G	G1	b	b1	b2	h	h1	h2	k	k1	w	p	Qty 2	Qty 1	UOM
			mm	mm	mm	inch	inch	mm	mm	mm	mm	mm	mm	mm	mm	mm	bar			
1088045	2X3/4 Euro	2	210	87	73	1	3/4	50	215	215	75	30	50	135	336	357	6	108	1	pce
1088046	3X3/4 Euro	3	260	87	73	1	3/4	50	215	215	75	30	50	185	336	357	6	108	1	pce
1088047	4X3/4 Euro	4	310	87	73	1	3/4	50	215	215	75	30	50	235	336	357	6	108	1	pce
1088048	5X3/4 Euro	5	360	87	73	1	3/4	50	215	215	75	30	50	285	336	357	6	108	1	pce
1088049	6X3/4 Euro	6	410	87	73	1	3/4	50	215	215	75	30	50	335	336	357	6	72	1	pce
1088050	7X3/4 Euro	7	460	87	73	1	3/4	50	215	215	75	30	50	385	336	357	6	72	1	pce
1088051	8X3/4 Euro	8	510	87	73	1	3/4	50	215	215	75	30	50	435	336	357	6	72	1	pce
1088052	9X3/4 Euro	9	560	87	73	1	3/4	50	215	215	75	30	50	485	336	357	6	72	1	pce
1088053	10X3/4 Euro	10	610	87	73	1	3/4	50	215	215	75	30	50	535	336	357	6	48	1	pce
1088054	11X3/4 Euro	11	660	87	73	1	3/4	50	215	215	75	30	50	585	336	357	6	48	1	pce
1088055	12x3/4 Euro	12	710	87	73	1	3/4	50	215	215	75	30	50	635	336	357	6	48	1	pce
1088868	13x3/4 Euro	13	760	87	73	1	3/4	50	215	215	75	30	50	685	336	357	6	48	1	pce
1088869	14x3/4 Euro	14	810	87	73	1	3/4	50	215	215	75	30	50	735	336	357	6	36	1	pce
1088870	15X3/4 Euro	15	860	87	73	1	3/4	50	215	215	75	30	50	785	336	357	6	36	1	pce
1088871	16X3/4 Euro	16	910	87	73	1	3/4	50	215	215	75	30	50	835	336	357	6	36	1	pce

Uponor Vario S actuator NC

- open/closed indicator
- operation at ambient temperature of up to +60°C
- protection class: IP54



	Item no.	Dimension	d	IG	OV	P	h	Qty 2	Qty 1	UOM
			mm	mm	V	W	mm			
NEW	1013008	24V NC FT30x1,5	40	30x1,5	24	~ 2	56	10	1	pce
NEW	1013006	230V NC FT30x1,5	40	30x1,5	230	~ 2	56	10	1	pce

Uponor Vario S thermometer



Item no.	di	do	h	Qty 2	Qty 1	UOM
	mm	mm	mm			
1086537	5	64	5	10	1	set

Uponor Vario S

Uponor Vario ball valve

- Made of brass, nickel-plated

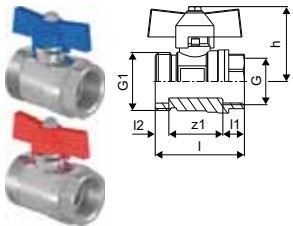

Item no.	Dimension	I	I1	I2	I3	G	G1	z1	Qty 2	Qty 1	UOM
		mm	mm	mm	mm	inch	inch	mm			
1086558	3/4-G1	51	12	8	43	3/4	1	31	10	1	set

Uponor Vario ball valve elbow

- Made of brass, nickel-plated

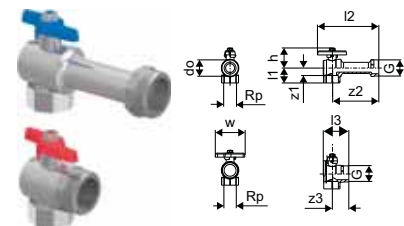

Item no.	Dimension	I1	I2	I3	do	G	Rp	z1	z2	z3	h	w	Qty 1	UOM
		mm	mm	mm	mm	inch	inch	mm	mm	mm	mm	mm		
1086559	Rp 3/4" - G1"	31	95	94	33	1	3/4	22	88	27	43	60	1	set

Uponor Vario actuator S

- for Vario B manifolds
- incl. 1 bayonet manifold valve adaptor ring M28x1.5mm and mounting instructions
- first open function
- autobalancing functionality for new and retrofit installations
- height: 58mm + adaptor ring
- stroke length: 5mm
- connection cable: 2x 0.75mm²x1m
- diameter: 44.3mm
- conformity: EAC
- color: blue
- 230V
- Ucoil: 230V/50Hz



Item no.	Dimension	d	IG	OV	P	h	Qty 2	Qty 1	UOM
		mm	mm	V	W	mm			
1087763	230V	44	30x1,5	230	~ 1	58	100	1	set

Uponor Vario

Uponor Vario balancing valve

- Balancing and shut-off of manifolds
- For zone control with Uponor actuator M30x1.5mm MT
- Housing - brass
- Hand wheels - polyamide
- Max. test pressure 10 bar

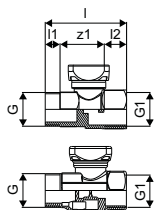

Item no.	Dimension	l	l1	l2	G	G1	z1	Qty 2	Qty 1	UOM
		mm	mm	mm	inch	inch	mm			
1005100	G1 - Rp1	80	15	22	1	1	44	10	1	set

Uponor Vario ball valve

- Made of brass nickel-plated
- For flat sealing vertical connection G1
- 60 mm + length of the manifold



Item no.	Dimension	AG	IG	Qty 2	Qty 1	UOM
		inch	inch			
1059132	NP G1-G1	1	1	10	1	set

Uponor Vario cabinet IW

- Complete cabinet with frame and door for in-wall installation
- Depth: 110mm, extendable to 150mm
- Height adjustable: 730 - 930mm
- Floor construction height: max. 200mm
- Material: galvanized steel
- White powder coated frame and door (RAL 9016)
- Lockable door

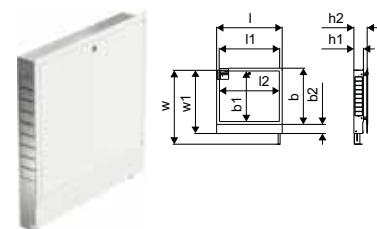

Item no.	Dimension	l	l1	l2	b	b1	b2	h1	h2	w	w1	Qty 2	Qty 1	UOM
		mm	mm	mm	mm	mm	mm	mm	mm	mm	mm			
1093473	550x730x110mm	605	550	539	650	572	108	110	150	930	730	27	1	pce
1093474	700x730x110mm	755	700	689	650	572	108	110	150	930	730	20	1	pce
1093475	850x730x110mm	905	850	839	650	572	108	110	150	930	730	18	1	pce
1093476	1000x730x110mm	1055	1000	989	650	572	108	110	150	930	730	13	1	pce
1093478	1300x730x110mm	1355	1300	1289	650	572	108	110	150	930	730	9	1	pce

Uponor Vario

Uponor Vario dominos set

- For Vario Cabinets IW an OW



Item no.	Dimension	Qty 2	Qty 1	UOM
1093522	(5pcs)	200	1	pce

Uponor Vario rail with 5 dominos

- C-Rail for fixation of manifold
- with 5 dominos
- with bolts 6mm, screws, nuts and washers

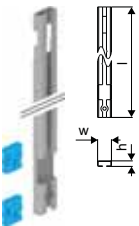

Item no.	l mm	h mm	w mm	Qty 2	Qty 1	UOM
1093555	577	10	25	200	1	pce

Uponor Vario cabinet on-wall AP

- Made of galvanised steel
- Height-adjustable to floor construction: +/- 15 mm.

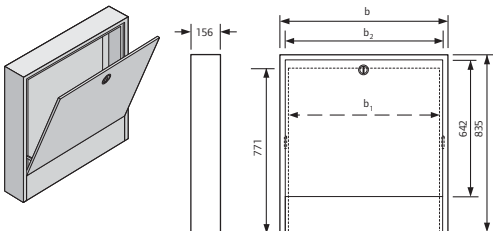

Item no.	Dimension	b mm	b1 mm	b2 mm	colour	Qty 2	Qty 1	UOM
1045481	1350x156mm	1350	1232	1290	RAL 9016	8	1	pce

Uponor Vario

Uponor Vario cabinet rear board AP

- Made of galvanised steel



Item no.	Dimension	b mm	Qty 1	UOM
1045485	1330mm	1330	1	pce

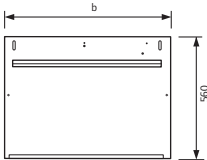

Uponor Vario cabinet on-wall NT

- Made of galvanized steel, white painted

- Lockable

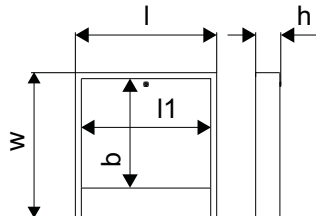

Item no.	Dimension	l mm	l1 mm	b mm	h mm	w mm	colour -	Qty 1	UOM
1046996	555x160mm	555	504	618	160	810	RAL 9010	1	pce
1046997	705x160mm	705	654	618	160	810	RAL 9010	10	1 pce
1046998	785x160mm	785	734	618	160	810	RAL 9010	1	pce
1046999	950x160mm	950	898	618	160	810	RAL 9010	1	pce

Uponor Smatrix Move PRO

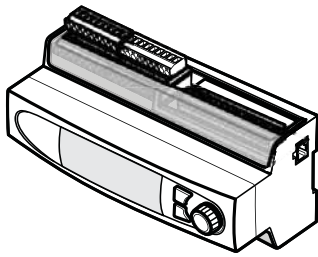

Uponor Smatrix Move PRO
It's a flexible, "installer-friendly" and versatile multi-zone supply water controller.
Fits different scenarios covering indoor and outdoor applications, radiant heating

and cooling, domestic hot water, etc. with one single controller.

Two different applications available, depending on SD card inserted: Heating only or Heating and Cooling.

Integration with Smatrix Base PRO room controls possible.

BMS ready, via Modbus interface or R-147 KNX Gateway (together with Smatrix Base PRO only)

Your benefits

- Multi application supply water temperature controller
- Control up to 4 different supply water temperatures simultaneously
- Intelligent auto heating/cooling switchover
- Selection of compensation modes
- Control snow/ice melting systems as well as turf heating



Specification

- multi-zone supply water temperature controls
- control up to 4 different supply water temperatures simultaneously
- intelligent auto heating/cooling changeover
- control snow/ice melting systems as well as turf heating
- integration with Smatrix Base PRO room controls possible
- optional connection to BMS via Modbus interface or R-147 KNX gateway (in combination with Smatrix Base PRO only)

Application

- supply water
- commercial buildings
- indoor and outdoor
- radiant heating and cooling
- domestic hot water
- heating only mode
- heating and cooling

Certification

- CE

Uponor Smatrix Move PRO

Uponor Smatrix Move PRO supply cont. X-159

- multi-zone supply water controller
- managing indoor climate in commercial buildings
- radiant heating and cooling
- domestic hot water

Functions:

- heating, cooling and domestic hot water
- up to 4 heating zones or 3 heating and 1 cooling zones
- up to 2 snowmelt zones
- stand-alone operation (with wired sensors) or integrated in a Uponor Smatrix Base PRO system
- integrable in a BMS via ModBus or KNX interface
- easy installation and configuration
- micro SD card allows backups and setting cloning

Content:

- Uponor Smatrix Move PRO controller X-159
- heating only application package (micro SD card, stickers, instructions)
- heating and cooling application package (micro SD card, stickers, instructions)
- quick start and mounting instructions
- additional conformity: EAC
- communication protocols: Modbus-RTU (slave), Uponor Smatrix Base PRO bus
- operational voltage: 230V 50Hz / 125mA
- operating temperature: 0°C ... +50°C
- protection class: IP20
- ERP class: III (1.5%) / VII (3.5%) if room sensor used



Item no.	OV V	I mm	b mm	d mm	Qty 2	Qty 1	UOM
1087155*	230	213,5	93,3	90	10	1	pce

Uponor Smatrix Move PRO snowmelt set S-152 + S-158

- snowmelt set for Uponor Smatrix Move PRO controller X-159
- compatible with hydronic systems (0-10V modulating 3-way valve or 2-way valve heat exchanger)
- 3 operation states: stop, idle, meltaway
- 1 protection mode: security (avoid damage on heat exchanger)

Content:

- 3x Uponor Smatrix Move Sensor Supply/Return S-152
- 2x Uponor Smatrix Move PRO Sensor Snow&Ice S-158 (ground sensor and mounting socket)
- short instructions incl. wiring diagrams

- additional conformity: EAC



Item no.	d mm	L m	h mm	Qty 1	UOM
1087158*				1	set
1087156	63	25	78	5	pce

Uponor Smatrix Move PRO

Uponor Smatrix Move PRO room sensor S-155

- room sensor
- measures room temperature
- for indoor heating and cooling zones with indoor compensation
- 2-wire connection to Uponor Smatrix Move PRO controller X-159

- additional conformity: EAC
- sensor type: NTC10
- temperature range: 0°C ... +60°C
- protection class: IP20



Item no.	OV V	l mm	b mm	d mm	Qty 2	Qty 1	UOM
1087159*	24	80	85	30	10	1	pce

Uponor Smatrix Move PRO humidity sensor S-157

- room sensor + RH
- measures relative humidity for dew point calculations
- for cooling only and heating and cooling zones
- 3-wire connection to Uponor Smatrix Move PRO controller X-159

- additional conformity: EAC
- humidity range: 0-100% non-condensing
- accuracy: $\pm 2\%RH$
- operating voltage: 24V / 50-60 Hz
- operating temperature: -10°C ... +50°C
- protection class: IP20



Item no.	OV V	l mm	b mm	d mm	Qty 2	Qty 1	UOM
1087160*	24	80	85	30	75	1	pce

Uponor Smatrix Move PRO

Uponor Smatrix Move PRO condensation set S-159

- protections radiant cooling installations from condensation
- stops cooling functionality temporarily if dew-point control is insufficient
- needs to be connected to a Uponor Smatrix Move PRO controller X-159

Content:

- pipe-mounting moisture sensor
- converter
- short instruction incl. wiring diagrams

- operating voltage: 24V / 50-60 Hz
- protection class: IP20



Item no.	OV V	I mm	b mm	d mm	Qty 2	Qty 1	UOM
1087165*	24	85	60	36	10	1	set

Uponor Smatrix Move actuator pro

- control signal: 0-10V
- compatible with 24V transformer (1048762) if 24V power supply is not available



Item no.	Dimension	OV V	Qty 1	UOM
1002356	A-15X 24V 0-10 V	24	1	pce

Uponor Smatrix Move

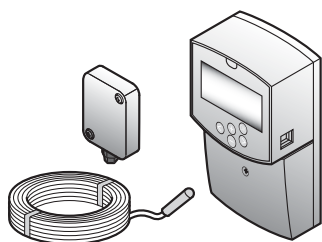

Uponor Smatrix Move is an intelligent supply water temperature controller for heating systems. It optimises supply water temperature by adjusting the setpoint based on measured outdoor or indoor temperatures. A

choice of compensation modes is available to provide optimal performance and energy efficiency.

Your benefits

- Comfort and Eco programming schedule
- Real time status information
- Pump logic for both stand alone and in combination with Uponor room controls
- Optional secondary heating/hot water circuit control



Specification

- comfort and Eco programming schedule
- real time status information
- pump logic for both stand alone and in combination with Uponor room temperature controls
- multiple compensation modes
- optional: secondary heating/hot water circuit control
- optional: snowmelt add-on
- optional: condensation protection

Application

- supply water temperature control

Certification

- CE

Uponor Smatrix Move

Uponor Smatrix Move supply cont. X-157 Wired

- supply water temperature controller
- control mode: heating only
- control principle: outdoor temperature compensation

Functions:

- mixing valve activation
- weekly program with 9 pre-programmed schedules
- 4 freely programmable schedules
- pump logic as stand alone
- pump logic in combination with Uponor Smatrix Base or Wave controller
- real time information of supply, outdoor and room temperature
- real time information of mixing valve status
- real time information of current day shown in a graph (comfort and reduced temperature)

Options:

- DHW production and boiler control
- HW heating circuit
- up to 100°C supply water control
- 2 powered general purpose outputs
- 2 general purpose inputs
- security contact thermostat
- 230V mixer motor

Content:

- Uponor Smatrix Move controller H
- supply/return sensor
- outdoor sensor

- protection class: IP30 II
- color: dark grey



Item no.	l mm	b mm	d mm	Qty 2	Qty 1	UOM
1071693	160	86	53	4	1	set

Uponor Smatrix Move

Uponor Smatrix Move PLUS antenna A-155 Radio

- sparepart antenna for Uponor Smatrix Move controller
- allows wireless connection to Uponor Smatrix Wave thermostats

Content:

- Uponor Smatrix Move antenna
- connection cable
- mounting material

- additional conformity: EAC



Item no.	Frequency MHz	l mm	b mm	d mm	Qty 2	Qty 1	UOM
1071676*	868	200	23	15	21	1	pce

Uponor Smatrix Move supply/return sensor S-152

- supply/return sensor
- measures supply or return temperature
- sensor type: NTC 10 kΩ at 25 °C
- length: 3m
- protection class: IP68 II



Item no.	Dimension	L m	Qty 2	Qty 1	UOM
1071661	3m	3	63	1	pce

Uponor Smatrix wallframe T-X A-1XX

- wallframe for Uponor Smatrix thermostats
- color: white glossy (RAL9016)



Item no.	Dimension	l mm	h mm	d mm	Qty 2	Qty 1	UOM
1086986	RAL9016	90	90	2,1	250	1	pce

Uponor Smatrix Move mixer motor 3 point 230V

- 3-point control
- for Uponor Smatrix Move controller



Item no.	OV V	Qty 1	UOM
1002357	230	1	pce

Uponor Smatrix Move

Uponor Fluvia Move PLUS actuator 230V

- Actuator 1084560 for pump groups MPG and CPG until 03.21
- Actuator 1119812 for pump groups MPG and CPG from 03.21



Item no.	OV V	Qty 2	Qty 1	UOM
1119812	230	10	1	pce
1084560	230	10	1	pce

Uponor Smatrix outdoor sensor S-1XX

- measures outdoor temperature
- incl. mounting material
- can be combined with Uponor Smatrix Wave/Move controller
- optional wireless connection, if combined with Uponor Smatrix Wave Thermostat Public
- protection class: IP55
- sensor type: NTC 10kOhm at 25°C
- color: light grey



Item no.	Qty 2	Qty 1	UOM
1071671*	45	1	pce

Uponor Smatrix relay module H/C M-1XX

- interface to a heating/cooling source
- switch over H/C between Uponor Smatrix and H/C source
- incl. socket for DIN rail mounting, manual, mounting material
- contact: 2 change-over (CO)
- Ucoil: 24VDC
- test voltage: 5kV
- protection class: IP40
- switching voltage: 380VAC, 125VDC
- switching current: 5A@250VAC, 5A@30VDC
- contact material: Ag+Au plated
- temperature range: -40°C...+70°C



Item no.	Dimension	OV V	I mm	b mm	d mm	Qty 2	Qty 1	UOM
1083576*	24V	24	85,5	16	70,5	84	1	pce

Uponor Smatrix Move

Uponor Smatrix relay module H/C M-1XX

- interface to a heating/cooling source
- switch over H/C between Uponor Smatrix and H/C source
- incl. socket for DIN rail mounting, manual, mounting material, wall box
- contact: 2 change-over (CO)
- Ucoil: 230VAC
- test voltage: 5kV
- protection class: IP40
- switching voltage: 380VAC, 125VDC
- switching current: 5A@250VAC, 5A@30VDC
- contact material: Ag+Au plated
- temperature range: -40°C...+70°C



Item no.	Dimension	OV V	l mm	b mm	d mm	Qty 2	Qty 1	UOM
1083577*	230V	230	85,5	16	70,5	16	1	pce

Uponor Fluvia Move/Move PLUS

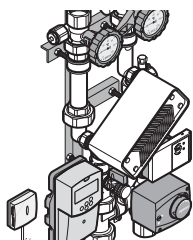

Uponor Fluvia Move Pump Groups are complete preassembled and full proved units to be used as part of the supply system which supports UFH installations in residential and commercial buildings.

Fluvia Move Pump Groups includes all components necessary for connection in to the pipe network, as well as Control units well defined acc to given application. The functional control setting of the unit: weather compensated control of supply hot water temperature and optional control of supply cooling water temperature.

Your benefits

- Complete preassembled units: hydraulically full proved pipe network, electrically wired and full proved
- Well designed Pump Groups include all necessary components
- Supply water control function by Uponor Smatrix Move control units
- With fixing brackets for mounting on the wall or in Uponor Cabinets
- Easy operation via Smatrix menu



Specification

- Pumpgroup pre-mounted with supply temperature controller Uponor Smatrix Move
- Outdoor temperature sensor (for installation on buildingsite)
- Water temperature sensor for supply temperature
- 3-way-mixing valve
- Motor drive
- Proportional pressure control
- Upgrade to heating/cooling possible

Application

- For weather compensated supply water temperature control
- Max. primary temperature: 90°C
- Max. secondary temperature: 55°C

Uponor Fluvia Move pumpgroup MPG-10-A-W

- Pump (WILO Yonos Para 15/6): Q: 0,1-2,5 m³/h, H: 6-2,4 m, EEI 0,17
- Ball valve + balancing valve primary
- Secondary connection G1 (MT)
- For installation left or right of manifold



Item no.	Flow Rate l/h	kvs m ³ /h	OV V	P W	p bar	b mm	b1 mm	Qty 2	Qty 1	UOM
1078306*	0,1-2,5	4,3	230	45	10	70	225/215	30	1	pce

Uponor Fluvia Move/Move PLUS

Uponor Fluvia pumpgroup MPG-10-B-W

- Pump WILO Yonos Para 15/6 RKA: Q: 0,1-2,5 m³/h, H: 6-2,4 m EEI 0,17
- Connection G1 (MT) secondary
- Ball valve+balancing valve primary
- For installation left or right of manifold



Item no.	Flow Rate l/h	kvs m ³ /h V	OV W	P W	p bar	b mm	b1 mm	Qty 2	Qty 1	UOM
1078307*	0,1-2,5	4,3	230	45	10	70	225/215	30	1	pce

Uponor Fluvia Move pumpgroup CPG-15-C-W

- For installation in central distribution room
- Nominal heat output: 15 kW
- Smatrix Move, 3-w-mixer and motor 230V
- Pump Wilo Para: Q: 0,1-2,5 m³/h, H: 6-2,4 m, EEI 0,17
- Primary connection Rp1 (FT)
- Secondary ball valves with thermometer, connection Rp1 (FT)

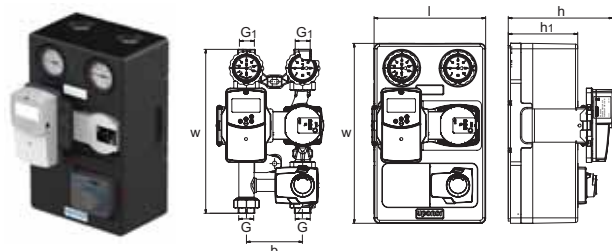

Item no.	l mm	G inch	G1 inch	b mm	h mm	h1 mm	w mm	w1 mm	kvs m ³ /h	p bar	Qty 2	Qty 1	UOM
NEW 1119445	248	1	1	125	232	154	365	400	2,5	- 12	18	1	pce

Uponor Fluvia Move pumpgroup CPG-15-A-W

- Pump Wilo Yonos Para 25/6 RKA: Q: 0,1-2,5 m³/h, H: 6-2,4 m, EEI 0,17
- Primary connection Rp1 (FT)
- Secondary ballvalves, connection Rp1 (FT)



Item no.	Flow Rate l/h	kvs m ³ /h V	OV W	P W	p bar	Qty 2	Qty 1	UOM
03.21 1078308	0,1-2,5	6,3	230	45	6	18	1	pce

Uponor Fluvia Move/Move PLUS

Uponor Fluvia pumpgroup CPG-15-D-W

- For installation in central distribution room
- Nominal heat output: 15 kW
- Pump Wilo Para: Q: 0,1-2,5 m³/h, H: 6-2,4 m, EEI 0,17
- Primary connection Rp1 (FT)
- Secondary ball valves with thermometer, connection Rp1 (FT)
- Uponor 3-way-mixer and Uponor Smatrix move controller can be adapted

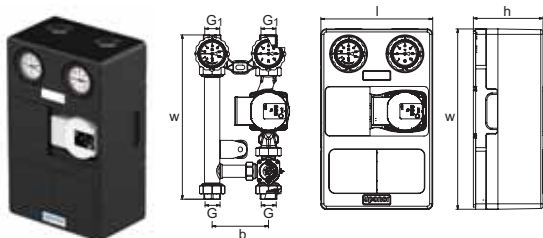

Item no.	l	G	G1	b	h	w	w1	kvs	p	Qty 2	Qty 1	UOM
	mm	inch	inch	mm	mm	mm	mm	m ³ /h	bar			
NEW 1119448	248	1	1	125	154	365	400	2,5	- 12	18	1	pce

Uponor Fluvia pumpgroup CPG-15-B-W

- Pump WILO Yonos Para 25/6: Q: 0,1-2,5 m³/h, H: 6-2,4 m EEI 0,17
- Primary connection Rp1 (FT)
- Secondary ballvalves, connection Rp1 (FT)



Item no.	Flow Rate	kvs	OV	P	p	Qty 2	Qty 1	UOM
	l/h	m ³ /h	V	W	bar			
03.21 1078309	0,1-2,5	6,3	230	45	6	18	1	pce

Uponor Fluvia E

Specification

- Pump Wilo Para: 1-8 0,1-8,3 m³/h, H: 8-2 m EEI <0,27
- With supply temperature control C-46 controller
- Prewired and prepared for wall-mounting
- Connection primary Rp1 (FT), ballvalves
- Connection secondary G1 ½ A, (MT), brass union connections

Application

- For weather compensated supply water temperature control
- Max. primary temperature: 90°C
- Max. secondary temperature: 55°C

Uponor Fluvia Move/Move PLUS

Uponor Smatrix Move actuator pro

- control signal: 0-10V
- compatible with 24V transformer (1048762) if 24V power supply is not available



Item no.	Dimension	OV V	Qty 1	UOM
1002356	A-15X 24V 0-10 V	24	1	pce

Uponor Smatrix Move mixer motor 3 point 230V

- 3-point control
- for Uponor Smatrix Move controller



Item no.	OV V	Qty 1	UOM
1002357	230	1	pce

Uponor Fluvia Move PLUS actuator 230V

- Actuator 1084560 for pump groups MPG and CPG until 03.21
- Actuator 1119812 for pump groups MPG and CPG from 03.21



Item no.	OV V	Qty 2	Qty 1	UOM
1084560	230	10	1	pce

Uponor Move PLUS

Specification

- Pump:Q: 0,1-2,5 m³/h, H: 6-2,4 m, EEI 0,17
- With heat exchanger
- Primary Rp1 1/4 (FT)
- Secondary ball valves flat sealing G1 (FT)

Application

- For hydraulic separation from ground collector
- For free-cooling
- Max. primary temperature: 90°C
- Max. secondary temperature: 55°C

Uponor Fluvia Move PLUS pumpgroup EPG-6-A-W

- Necessary control accessories:
- Uponor Smatrix Thermostat T-168 (1071689)
- Uponor Smatrix Antenna (1071676)



Item no.	Flow Rate l/h	kvs m ³ /h	OV V	P W	p bar	Q kW	Qty 2	Qty 1	UOM
1078310	0,1-2,5	7	230	45	6	1-6	8	1	pce

Uponor Fluvia T

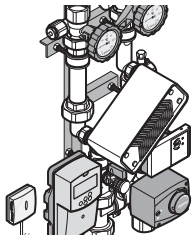

Uponor Fluvia T Pump Groups are complete preassembled and full proved units to be used as part of the supply system which supports UFH installations in residential and commercial buildings.

Fluvia T Pump Groups includes all components necessary for connection in to the pipe network.

The functional control setting of the unit: constant supply hot water temperature control.

Your benefits

- Complete preassembled units: hydraulically full proved pipe network
- Well designed Pump Groups include all necessary components
- Supply water control function by Thermostat head or by Actuator
- With fixing brackets for mounting on the wall or in Uponor Cabinets
- Easy operation



Specification

- Integrated pump: Q: 0,1 - 0,4 m³/h, H: 0,2 - 1,1 m, Phyd< 1W
- Bracket for left- or right installation
- Air bleed screw
- Secondary circuit temp. range 20-50°C
- Balancing valve
- Secondary loop 3/4" eurocone
- Primary valves with clampconnection for CU-Pipe 15mm

Application

- For control of UFH in small zones
- Max. primary temperature: 90°C
- Max. secondary temperature: 55°C

Uponor Fluvia T pumpgroup Push-12 TH-G

- Pumpgroup with thermostat 12-28°C
- Secondary max. temperature limiter by 50°C

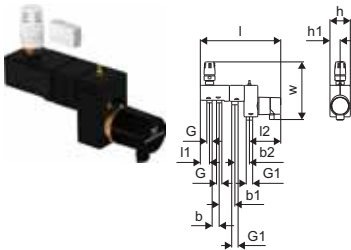

Item no.	l	l1	l2	G	G1	b	b1	b2	h	h1	w	Qty 2	Qty 1	UOM
	mm	mm	mm	inch	inch	mm	mm	mm	mm	mm	mm			
1095127	332	38	129	5/8	3/4	40	65	65	84	42	240	60	1	pce

Uponor Fluvia T

Uponor Fluvia T pumpgroup Push-12 CH-G

- With cartridge heater for UFH in summer mode
- Room temperature control by controller X-161
- Compatible to Uponor Smatrix Wave thermostats T-166, T-168 , T-169
- With safety sensor against overheating
- Secondary max. temperature limiter by 50°C

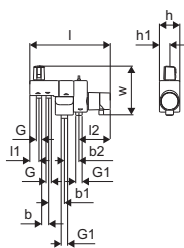

Item no.	Qty 2	Qty 1	UOM
1095131	30	1	pce

Uponor Fluvia T pumpgroup Push-12 AC-G

- Pumpgroup with actuator 230 V
- Secondary max. temperature limiter by 50°C

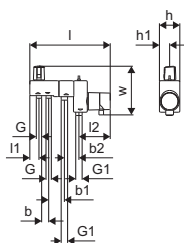

Item no.	Qty 2	Qty 1	UOM
1095128	60	1	pce

Uponor Fluvia T pumpgroup Push-12 WL-G

- Pumpgroup with actuator 230 V, wireless thermostat and wireless receiver
- Secondary max. temperature limiter by 60°C

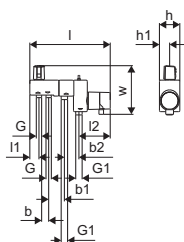

Item no.	Qty 2	Qty 1	UOM
1095130	60	1	pce

Uponor Fluvia T

Uponor Fluvia T pumpgroup control kit

Specification

- Wireless Thermostat T-166: room temperature range 5-37°C
- Supply temp limit setting
- Compatible to Uponor Smatrix Wave Thermostats T-166, T-168, T-169
- Actuator 230V M28x1.5mm FT: for connection to the pump group

Application

- For update of existing Uponor Fluvia T Push-12 AC or Push -12 TH by wireless room thermostat

Uponor Fluvia T control set Push-12 WL-REC-AC

- For update of Uponor Fluvia T Push-12 TH



Item no.	Dimension	OV V	Qty 2	Qty 1	UOM
1071999	WL-REC-AC	230	10	1	pce

Uponor Fluvia T pumpgroup PUSH

Specification

- Pump WILO: Q: 0,1-1,5 m³/h, H: 6,2-2,4 m EEI <=0,2
- Constant flow temperature control: 20-55°C
- with Thermometer
- with venting valve
- Easy filling by non-return valve

Application

- For connection to Uponor manifolds, installation with manifolds on-wall or in cabinets
- Max. primary temperature: 90°C
- Max. secondary temperature: 55°C

Uponor Fluvia T pumpgroup Push-23-B-W

- Maximal heat load: 10 kW
- kvs flow valve: 1,2 m³/h
- Water temperature and flow rates controlled by thermostat with capillary sensor



Item no.	Flow Rate l/h	kvs m³/h	OV V	P W	p bar	Q kW	b mm	b1 mm	Qty 2	Qty 1	UOM
1078304	0,1-2,5	S 1,2 / R 2,7	230	45	10	10	70	225/215	55	1	pce

Uponor Smatrix Wave / Style

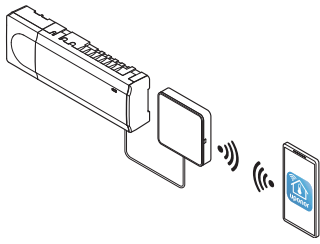

The Smatrix Wave radio control system includes autobalancing technology as well as other energy-efficient features for radiant heating and cooling systems. Wave also enables remote control through the Smatrix App. The

end user has the ability to make changes remotely.

Your benefits

- Remote access possibility via Smatrix App
- No manual balancing required
- Fast installation, minimal wiring
- Simple intuitive end user control
- Wide range of energy efficiency features



Specification

- up to 4 controller in one system
- operating voltage: 230V
- autobalancing optimises energy use and comfort
- electric control
- supports up to 6 room thermostats and 8 actuators (24V) per controller
- pump and boiler relays
- valve and pump exercise
- relative humidity control
- combines underfloor heating/cooling and ceiling cooling control
- max. power input per actuator: 24VAC / 0.2A (0.4A peak)
- integrated heat pump module (only X-165)
- data cloning, logging, backup and updates via micro SD card (only X-165)

Smatrix Wave Pulse:

- local access (Wi-Fi) or remote access (internet connection required) via Uponor Smatrix Pulse App (with R-208)
- temporary wi-fi access point for direct access (if local wi-fi is not available) (with R-208)
- smart home ecosystem integration (Amazon Alexa, Google Home) (with R-208)
- multi-home control (with R-208)
- third-party access for remote support (user allowance required) (with R-208)
- history trend analysis via Uponor Smatrix Pulse app (with R-208)
- timer programming (with R-208)
- comfort settings (with R-208)
- supply diagnostics (with R-208)

Smatrix Wave:

- displays controller information and settings (with I-167)
- temperature setback programs for each channel (with I-167)
- max/min temperature limitations (with I-167)
- holiday settings (with I-167)
- automatic summer/winter change (with I-167)
- room bypass function (with I-167)
- system diagnostic (with I-167)
- trend visualization (set point vs. room temperature, etc.) (with I-167)
- accessories configuration (with I-167)
- local access (Wi-Fi) or remote access (internet connection required) via Uponor Smatrix App (with R-167)
- status and energy efficiency level information (with R-167)
- data logging for energy optimization or system maintenance (with R-167)

Application

- wireless room temperature control for radiant heating and cooling
- set point range: +5°C ... +35°C

Certification

- CE / EAC

Uponor Smatrix Wave / Style

Uponor Smatrix Wave starter set Pulse S

- ready-to-use carefree package with basic system setup for appartments
- extendable on demand
- compatible to Uponor Smatrix Wave controller Pulse X-265 6X
- protection class: Class II IP20
- color: white

Consisting of:

- 1x Uponor Smatrix Pulse com R-208
- 1x Uponor Smatrix Wave controller Pulse X-265 6X
- 3x Uponor Smatrix Wave thermostat D+RH Style T-169
- first step instructions, safety instructions
- mounting material



Item no.	OV V	Frequency MHz	Qty 2	Qty 1	UOM
1093284	230	868	3	1	set

Uponor Smatrix Wave starter set Pulse L

- ready-to-use carefree package with basic system setup for single family homes
- extendable on demand
- compatible to Uponor Smatrix Wave controller Pulse X-265 6X
- protection class: Class II IP20
- color: white

Consisting of:

- 1x Uponor Smatrix Pulse com R-208
- 2x Uponor Smatrix Wave controller Pulse X-265 6X
- 5x Uponor Smatrix Wave thermostat D+RH Style T-169
- first step instructions, safety instructions
- mounting material



Item no.	OV V	Frequency MHz	Qty 2	Qty 1	UOM
1093287	230	868	2	1	set

Uponor Smatrix Wave / Style

Uponor Smatrix Wave control set Pulse X-265+R-208 6X

- ready-to-use control set
- extendable on demand
- compatible to Uponor Smatrix Wave controller Pulse X-265 6X
- protection class: Class II IP20
- color: white

Consisting of:

- 1x Uponor Smatrix Pulse com R-208
- 1x Uponor Smatrix Base controller Pulse X-265 6X
- first step instructions, safety instructions
- mounting material



Item no.	OV V	Frequency MHz	Qty 2	Qty 1	UOM
1093024	230	868	3	1	set

Uponor Smatrix Pulse com R-208

- establishes connection between Uponor Smatrix Pulse system, Uponor Smatrix Pulse app and the Uponor cloud

compatible to:

- Uponor Smatrix Base controller Pulse X-245 Bus 6X
- Uponor Smatrix Wave controller Pulse X-265 6X
- power supply: RJ45 cable to Uponor Wave or Base controller Pulse
- ethernet interface: 10/100 Mbps (RJ45)
- ethernet protocols: Ethernet II
- protection class: Class II IP20
- color: white

Consisting of:

- Uponor Smatrix Pulse com R-208
- adaptor for DIN rail installations
- RJ45 connection cable (2m)
- first step instructions, safety instructions
- mounting material



Item no.	Frequency MHz	l mm	b mm	d mm	Qty 2	Qty 1	UOM
1093030	868	110	21	110	16	1	pce

Uponor Smatrix Wave / Style

Uponor Smatrix Wave controller Pulse X-265 6X

- compatible to Uponor Smatrix Wave controller Pulse X-265 6X
- protection class: Class II IP20
- color: white

Consisting of:

- Uponor Smatrix Wave controller Pulse X-265 6X
- Uponor Smatrix Wave antenna Pulse A-265
- first step instructions, safety instructions
- mounting material



Item no.	OV V	Frequency MHz	l mm	b mm	d mm	Qty 2	Qty 1	UOM
1093021	230	868	340	110	55	4	1	pce

Uponor Smatrix Wave slave module Pulse M-262 6X

- 6 channel slave module for Uponor Smatrix Wave controller Pulse X-265 6X
- supports up to 6 room thermostats and 6 actuators
- click-in installation
- protection class: IP20
- color: white



Item no.	l mm	b mm	d mm	Qty 2	Qty 1	UOM
1093133	141	110	55	16	1	pce

Uponor Smatrix Wave antenna Pulse A-265

- sparepart antenna for Uponor Smatrix Wave controller Pulse X-265 6X
- cable length: 3m
- plug: RJ45
- color: white

Consisting of:

- Uponor SPI Smatrix Wave antenna Pulse A-265 (incl. fixed connection cable)
- mounting material



Item no.	Frequency MHz	l mm	b mm	d mm	Qty 2	Qty 1	UOM
1093028	868	30	110	9	16	1	pce

Uponor Smatrix Wave / Style

Uponor Smatrix Wave relay module M-161

- dual output receiver for Uponor Smatrix Wave controller or Uponor Smatrix Wave controller Pulse
- 2 potential free or live 230V 5A outputs
- pump / dehumidifier mode
- pump / H/C changeover mode
- boiler / chiller mode
- operating distance: max. 30m
- protection class: Class II IP30
- color: white

Consisting of:

- Uponor Smatrix Wave relay module M-161 2X
- power supply
- mounting material



Item no.	Dimension	Frequency MHz	l mm	b mm	d mm	Qty 2	Qty 1	UOM
1071673	2X	868	50	170,35	27,50	16	1	pce

Uponor Smatrix Wave thermostat D+RH Style T-169

- measures and displays the perceived room temperature and relative humidity
- color: white RAL 9016

Functions:

- heating or cooling demand indication
- RH measured value
- comfort / ECO indication
- ECO setback modification
- manual H/C switchover function
- cooling allowed function (room by room)
- displays celsius or fahrenheit
- operating modes: room temperature (RT), internal with floor max/min (RFT), remote sensor (RS), remote outdoor (RO)
- low battery indication
- temperature calibration
- compatibility with Smatrix Move Controller H/C Radio X-158
- optional: floor, remote or outdoor sensor can be connected

Consisting of:

- Uponor Smatrix Wave thermostat D+RH Style T-169
- 1x CR2032 battery
- mounting material



Item no.	Frequency MHz	l mm	b mm	d mm	Qty 2	Qty 1	UOM
1087816	868	80	80	9	180	1	pce

Uponor Smatrix Wave / Style

Uponor Smatrix Wave thermostat D+RH Style T-169

- measures and displays the perceived room temperature and relative humidity
- color: black

Functions:

- heating or cooling demand indication
- RH measured value
- comfort / ECO indication
- ECO setback modification
- manual H/C switchover function
- cooling allowed function (room by room)
- displays celsius or fahrenheit
- operating modes: room temperature (RT), internal with floor max/min (RFT), remote sensor (RS), remote outdoor (RO)
- low battery indication
- temperature calibration
- compatibility with Smatrix Move Controller H/C Radio X-158
- optional: floor, remote or outdoor sensor can be connected

Consisting of:

- Uponor Smatrix Wave thermostat D+RH Style T-169
- 1x CR2032 battery
- mounting material



Item no.	Dimension	Frequency MHz	l mm	b mm	d mm	Qty 2	Qty 1	UOM
1087817	BLACK	868	80	80	9	180	1	pce

Uponor Smatrix Wave room sensor RH Style T-161

- room temperature and relative humidity sensor (flush mounted)
- operating distance: max. 30m
- protection class: IP30
- color: white RAL9016

Content:

- Uponor Smatrix Wave room sensor+RH Style T-161
- 1x CR2032 battery
- mounting material



Item no.	Frequency MHz	l mm	b mm	d mm	Qty 2	Qty 1	UOM
1087815	868	55	55	9	180	1	pce

Uponor Smatrix Wave / Style

Uponor Smatrix Wave thermostat P+RH T-168

- measures and displays the perceived room temperature and relative humidity
- color: white glossy

Functions:

- heating or cooling demand indication
- RH limit indication
- individual night setback
- set time start up wizard
- 6 pre-programmed schedules
- 1 freely programmable schedule
- manual H/C changeover function (available with Uponor Smatrix Move only)
- cooling allowed function (room by room)
- displays celsius or fahrenheit
- operating modes: room temperature (RT), internal with floor max/min (RFT), remote sensor (RS), remote outdoor (RO)
- backlight (dims 10 seconds after last button event)
- displays software version (on power-up)
- low battery indication
- compatibility with Smatrix Move Controller H/C Radio C-157
- optional: floor or outdoor sensor can be connected

Consisting of:

- Uponor Smatrix Wave thermostat prog.+RH T-168
- 2x AAA batteries
- mounting material



Item no.	Dimension	Frequency MHz	l mm	b mm	d mm	Qty 2	Qty 1	UOM
1086984	RAL9016	868	80	80	26,5	75	1	pce

Uponor Smatrix Wave / Style

Uponor Smatrix Wave thermostat D T-166

- measures and displays the perceived room temperature
- operating distance: max. 30m
- protection class: IP30
- color: white glossy

Functions:

- heating or cooling demand indication
- manual H/C changeover function (available with Uponor Smatrix Move only)
- cooling allowed function (room by room)
- displays celsius or fahrenheit
- operating modes: room temperature (RT), internal with floor max/min (RFT), remote sensor (RS), remote outdoor (RO)
- low battery indication
- mode reception from timer
- night set back
- display with backlight (dims 10 seconds after last button event)
- displays software version (on power-up)
- compatibility with Uponor Smatrix Move controller H/C Radio C-157
- optional: floor sensor can be connected

Consisting of:

- Uponor Smatrix Wave thermostat digital T-166
- 2x AAA batteries
- mounting material



Item no.	Dimension	Frequency MHz	l mm	b mm	d mm	Qty 2	Qty 1	UOM
1086982	RAL9016	868	80	80	26,5	75	1	pce

Uponor Smatrix Wave / Style

Uponor Smatrix Wave PLUS thermostat D+RH T-167 grey

- measures and displays the perceived room temperature and relative humidity
- operating distance: max. 30m
- protection class: IP20
- color: dark grey glossy

Functions:

- heating or cooling demand indication
- RH limit indication
- comfort/ECO state change from system devices
- ECO setback modification
- manual H/C changeover function
- cooling allowed function (room by room)
- displays celsius or fahrenheit
- operating modes: room temperature (RT), internal with floor max/min (RFT), remote sensor (RS), remote outdoor (RO)
- backlight (dims 10 seconds after last button event)
- displays software version (on power-up)
- low battery indication
- compatibility with Smatrix Move Controller H/C Radio X-158
- optional: floor, remote and outdoor sensor can be connected

Content:

- Uponor Smatrix Wave PLUS thermostat D+RH T-167 grey
- 2x AAA batteries
- mounting material



12.21

Item no.	Frequency MHz	l mm	b mm	d mm	Qty 2	Qty 1	UOM
1071674	868	80	80	26,50	75	1	pce

Uponor Smatrix Wave thermostat standard T-165 POD

- measures perceived room temperature
- protection class: IP30
- color: white glossy

Functions:

- light indication behind dial after changing the set point
- heating/cooling demand indication
- dip switch to enable/disable timer function if timer installed
- optional: enable/disable timer function

Consisting of:

- Uponor Smatrix Wave thermostat standard T-165 POD
- 2x AAA batteries
- mounting material



Item no.	Dimension	Frequency MHz	l mm	b mm	h mm	Qty 2	Qty 1	UOM
1086981	RAL9016	868	80	80	26,5	75	1	pce

Uponor Smatrix Wave / Style

Uponor Smatrix Wave thermostat public T-163

- measures perceived room temperature
- operating distance: max. 30m
- color: white glossy

Functions:

- potentiometer on rear side to adjust setpoint temperature
- tamper detector
- dry contact input for forced ECO via e.g. SMS module or BMS
- dry contact input for heating/cooling changeover
- dip switch for function/sensor selection
- optional: floor, outdoor or remote sensor can be connected

Consisting of:

- Uponor Smatrix Wave thermostat public T-163
- 2x AAA batteries
- mounting material



Item no.	Dimension	Frequency MHz	l mm	b mm	d mm	Qty 2	Qty 1	UOM
1086979	RAL9016	868	80	80	26,5	75	1	pce

Uponor Smatrix wallframe T-X A-1XX

- wallframe for Uponor Smatrix thermostats
- color: white glossy (RAL9016)



Item no.	Dimension	l mm	h mm	d mm	Qty 2	Qty 1	UOM
1086986	RAL9016	90	90	2,1	250	1	pce

Uponor Smatrix floor/remote sensor S-1XX

- can be combined with Uponor Smatrix Wave/Base(Pro) thermostats
- can be used as floor or remote sensor
- length: 3m
- sensor type: NTC 10kOhm at 25°C



Item no.	L m	Qty 2	Qty 1	UOM
1071684	3	63	1	pce

Uponor Smatrix Wave / Style

Uponor Smatrix relay module H/C M-1XX

- interface to a heating/cooling source
- switch over H/C between Uponor Smatrix and H/C source
- incl. socket for DIN rail mounting, manual, mounting material
- contact: 2 change-over (CO)
- Ucoil: 24VDC
- test voltage: 5kV
- protection class: IP40
- switching voltage: 380VAC, 125VDC
- switching current: 5A@250VAC, 5A@30VDC
- contact material: Ag+Au plated
- temperature range: -40°C...+70°C



Item no.	Dimension	OV V	I mm	b mm	d mm	Qty 2	Qty 1	UOM
1083576	24V	24	85,5	16	70,5	84	1	pce

Uponor Smatrix relay module H/C M-1XX

- interface to a heating/cooling source
- switch over H/C between Uponor Smatrix and H/C source
- incl. socket for DIN rail mounting, manual, mounting material, wall box
- contact: 2 change-over (CO)
- Ucoil: 230VAC
- test voltage: 5kV
- protection class: IP40
- switching voltage: 380VAC, 125VDC
- switching current: 5A@250VAC, 5A@30VDC
- contact material: Ag+Au plated
- temperature range: -40°C...+70°C



Item no.	Dimension	OV V	I mm	b mm	d mm	Qty 2	Qty 1	UOM
1083577	230V	230	85,5	16	70,5	16	1	pce

Uponor Smatrix Wave / Style

Uponor Smatrix actuator retrofit set A-XXX

- 24V actuator retrofit set
 - incl. 3 bayonet manifold valve adaptor rings, mounting instructions
 - interface between existing third-party manifolds and Uponor Smatrix control system
 - compatible to 80% of existing third-party manifolds
 - open/closed indicator
 - NC (normally closed) = closes without power
 - first open function
 - Autobalancing functionality for new and retrofit installations
 - temperature range: 0°C...60°C
 - height: 58mm + adaptor ring
 - color: blue
- adaption list can be found at: www.uponor.com/download-centre
- stroke length: 5mm
 - connection cable: 2x 0.75mm² x 1m
 - Ucoil: 24V/50Hz
 - Pcoil: 1W
 - diameter: 44.3mm



Item no.	Dimension	d mm	OV V	P W	h mm	Qty 2	Qty 1	UOM
1083575	24V, NC, 1W	44	24	~ 1	58	100	1	set

Uponor Vario PLUS actuator NC

- open/closed indicator
- operation at ambient temperature of up to +60°C
- protection class: IP54



Item no.	Dimension	d mm	AG mm	OV V	P W	h mm	Qty 2	Qty 1	UOM
NEW 1000138	24V MT30x1,5	40	30x1,5	24	~2	54	10	1	pce

Uponor Vario S actuator NC

- open/closed indicator
- operation at ambient temperature of up to +60°C
- protection class: IP54



Item no.	Dimension	d mm	IG mm	OV V	P W	h mm	Qty 2	Qty 1	UOM
NEW 1013008	24V NC FT30x1,5	40	30x1,5	24	~ 2	56	10	1	pce

Uponor Smatrix Base PRO / Style

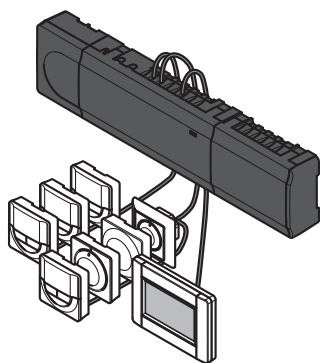

Uponor Smatrix Base PRO, featuring autobalancing technology, is an easy to use, intelligent room control system.

Smatrix Base Pro is available for integration into KNX or BMS Modbus RTU, but also as stand-alone solution with user friendly touch screen.

Your benefits

- Can be used for both radiant heating and cooling
- No manual balancing required
- Fast installation
- Simple end user control
- Modbus or KNX integration



Specification

- autobalancing optimizing energy use and comfort
- up to 6 room thermostats and 8 actuators (24V) per controller; 6 channel expansion module option (with M-140)
- pump and boiler relays
- valve and pump exercise

Smatrix Base Pro controller X-147 with optional touch screen I-147 and KNX option

- up to 16 controller in one system
- daisy chain wiring or star wiring (with M-141)
- optional: display of controller information and settings (with I-147)
- optional: BMS integration via KNX interface (with R-147 and I-147)

Comfort settings comprises (with I-147)

- temperature setback programs for each channel
- max/min temperature limitations and relative humidity control
- holiday settings and automatic summer/winter change
- room bypass function
- advance cooling settings and automatic summer/winter change
- trend visualization (set point vs. room temperature, etc.)
- accessories configuration
- room check function and system diagnostic

Smatrix Base Pro controller X-148 ModBus RTU

Read data points

- temperature: outdoor / room / floor
- humidity level
- status of: actuator / pump / boiler / general purpose input (GPI)
- connection status of thermostat
- dynamic heat curve offset in integrated heat pump

Read and write data points

- room setpoint
- min/max levels for: setpoint / floor temperature
- settings: comfort/eco and autobalancing on/off
- heating/cooling: state / offset
- cooling not allowed for a room
- integrated heat pump defrost state

Application

- wired room temperature control for radiant heating and cooling
- set point range: +5°C ... +35°C

Certification

- CE

Uponor Smatrix Base PRO / Style

Uponor Smatrix Base PRO control set X-147 + I-147 Bus

- supports up to 6 room thermostats and 8 actuators
- option to extend up to 12 room thermostats and 14 actuators with 1071686
- max. power input per actuator: 24VAC / 0.2A (0.4A peak)
- protection class: Class II IP20
- color: grey RAL7015

Consisting of:

- Uponor Smatrix Base PRO interface I-147 Bus
- Uponor Smatrix Base PRO controller X-147 Bus 6X
- quick guide, security instructions
- 2x micro SD card for touch panel and controller (pre-inserted)
- DIN rail (length: 37cm)
- mounting material

- protection class: Class II IP20
- color: grey RAL7015



Item no.	Dimension	OV V	Frequency MHz	Qty 2	Qty 1	UOM
1087163	6X	230	868	3	1	set

Uponor Smatrix Base PRO controller X-147 Bus

- supports up to 6 room thermostats and 8 actuators
- option to extend up to 12 room thermostats and 14 actuators with 1071686
- max. power input per actuator: 24VAC / 0.2A (0.4A peak)
- protection class: Class II IP20
- color: grey RAL7015

Consisting of:

- Uponor Smatrix Base PRO controller X-147 Bus 6X
- quick guide, security instructions
- micro SD card (pre-inserted)
- DIN rail (length: 37cm)
- mounting material



Item no.	Dimension	OV V	l mm	b mm	d mm	Qty 2	Qty 1	UOM
1087162	6X	230	336	110	55	4	1	pce

Uponor Smatrix Base PRO / Style

Uponor Smatrix Base slave module M-140 Bus

- 6 channel slave module for Uponor Smatrix Base controller X-145 Bus 6X and Uponor Smatrix Base PRO controller X-147 Bus 6X and Uponor Smatrix Base pro controller X-148 Modbus RTU
- supports up to 6 room thermostats and 6 actuators
- click-in installation
- protection class: IP20
- color: grey



Item no.	Dimension	l mm	b mm	d mm	Qty 2	Qty 1	UOM
1071686	6X	141	110	55	16	1	pce

Uponor Smatrix Base star module M-141 Bus

- 6 channel star module for Uponor Smatrix Base controller X-145 Bus 6X and Uponor Smatrix Base PRO controller X-147 Bus 6X
- flexible wiring approaches possible (star topology)
- supports up to 6 room thermostats
- protection class: IP20
- color: grey



Item no.	Dimension	l mm	h mm	d mm	Qty 2	Qty 1	UOM
1071651	8X	141	110	55	16	1	pce

Uponor Smatrix Base PRO interface I-147 Bus

- sparepart touchpanel for Uponor Smatrix Base controller X-147 Bus 6X
- protection class: Class II IP20
- color: white RAL9016

Consisting of:

- Uponor Smatrix Base PRO interface I-147
- power supply
- mounting material
- wall bracket
- instruction leaflet



Item no.	Qty 2	Qty 1	UOM
1087161	7	1	pce

Uponor Smatrix Base PRO / Style

Uponor Smatrix Base PRO room sensor RH Style T-141 Bus

- room temperature and relative humidity sensor (flush mounted)
- protection class: IP30
- color: white RAL9016

Consisting of:

- Uponor Smatrix Base PRO room sensor+RH Style T-141 Bus
- mounting material



Item no.	Dimension	l mm	b mm	d mm	Qty 2	Qty 1	UOM
1087812	FLUSH	55	55	9	180	1	pce

Uponor Smatrix Base PRO gateway module R-147 KNX

- connects a Uponor Smatrix Base PRO controller X-147 with a BMS or third-party KNX devices
- power supply: 230VAC (+10%/-15%) / 50/60Hz
- internal fuse: T5 F3.15AL 250V, 5x20 3.15A quick acting
- operating temperature: 0°C ... +45°C
- storage temperature: -20°C ... +70°C
- max. consumption: 45W
- power connection: 1m cable with europlug
- connection terminals for system bus: 0.2mm² ... 1.5mm²
- protection class: IP20 II

Functions:

- room temperature from Uponor Base or third-party KNX thermostats
- room setpoint from Uponor Base or third-party KNX thermostats
- room relative humidity from Uponor Base or third-party KNX thermostats
- room floor temperature from Uponor Base or third-party KNX thermostats
- actuator status from Uponor Base or third-party KNX system
- forced ECO from Uponor Base PRO or third-party KNX system
- pump output from Uponor Base or third-party KNX system
- boiler output from Uponor Base or third-party KNX system
- heating/cooling curve settings/circuit from Uponor Move PRO to BMS or vice versa
- heating/cooling modes from Uponor Base PRO to BMS or vice versa

Consisting of:

- gateway module R-147 KNX
- power supply
- mounting material (2 screws and 2 wall plugs)
- quick guide



Item no.	OV V	l mm	b mm	d mm	Qty 1	UOM
1087164	230	90	17,5	60	1	pce

Uponor Smatrix Base / Style

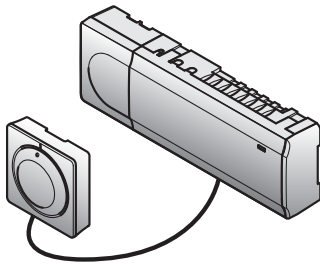

Uponor Smatrix Base, featuring autobalancing technology, is an easy to use, intelligent room control system. Autobalancing optimises energy use and comfort by constantly monitoring and adapting the system to changing

demands. A further advantage is the choice of wiring options adding flexibility and speed to an installation.

Your benefits

- Can be used for both radiant heating and cooling
- No manual balancing required
- Fast installation
- Simple end user control
- Low maintenance



Specification

- up to 4 controller in one system
- operating voltage: 230V
- autobalancing optimises energy use and comfort
- electric control
- supports up to 6 room thermostats and 8 actuators (24V) per controller
- pump and boiler relays
- valve and pump exercise
- relative humidity control
- different wiring options (daisy chain / star)
- 4-wire Bus installation
- communication protocol: RS485 serial bus
- max. power input per actuator: 24VAC / 0.2A (0.4A peak)

Smatrix Base Pulse:

- local access (Wi-Fi) or remote access (internet connection required) via Uponor Smatrix Pulse App (with R-208)
- temporary wi-fi access point for direct access (if local wi-fi is not available) (with R-208)
- smart home ecosystem integration (Amazon Alexa, Google Home) (with R-208)
- multi-home control (with R-208)
- third-party access for remote support (user allowance required) (with R-208)
- history trend analysis via Uponor Smatrix Pulse app (with R-208)
- timer programming (with R-208)
- comfort settings (with R-208)
- supply diagnostics (with R-208)

Application

- wired room temperature control for radiant heating and cooling
- set point range: +5°C ... +35°C

Certification

- CE / EAC

Uponor Smatrix Base / Style

Uponor Smatrix Base starter set Pulse S

- ready-to-use carefree package with basic system setup for appartments
- extendable on demand
- compatible to Uponor Smatrix Base controller Pulse X-245 Bus 6X
- protection class: Class II IP20
- color: white

Consisting of:

- 1x Uponor Smatrix com Pulse R-208
- 1x Uponor Smatrix Base controller Pulse X-245 Bus 6X
- 3x Uponor Smatrix Base thermostat D+RH Style T-149 Bus
- first step instructions, safety instructions
- mounting material



Item no.	Qty 2	Qty 1	UOM
1093280	3	1	set

Uponor Smatrix Base starter set Pulse L

- ready-to-use carefree package with basic system setup for single family homes
- extendable on demand
- compatible to Uponor Smatrix Base controller Pulse X-245 Bus 6X
- protection class: Class II IP20
- color: white

Consisting of:

- 1x Uponor Smatrix com Pulse R-208
- 2x Uponor Smatrix Base controller Pulse X-245 Bus 6X
- 5x Uponor Smatrix Base thermostat D+RH Style T-149 Bus
- first step instructions, safety instructions
- mounting material



Item no.	Qty 2	Qty 1	UOM
1093282	2	1	set

Uponor Smatrix Base / Style

Uponor Smatrix Base control set Pulse X-245+R-208 6X

- ready-to-use control set
- extendable on demand
- compatible to Uponor Smatrix Base controller Pulse X-245 Bus 6X
- protection class: Class II IP20
- color: white

Consisting of:

- 1x Uponor Smatrix Pulse com R-208
- 1x Uponor Smatrix Base controller Pulse X-245 Bus 6X
- first step instructions, safety instructions
- mounting material



Item no.	OV V	Qty 2	Qty 1	UOM
1093019	230	3	1	set

Uponor Smatrix Pulse com R-208

- establishes connection between Uponor Smatrix Pulse system, Uponor Smatrix Pulse app and the Uponor cloud

compatible to:

- Uponor Smatrix Base controller Pulse X-245 Bus 6X
- Uponor Smatrix Wave controller Pulse X-265 6X
- power supply: RJ45 cable to Uponor Wave or Base controller Pulse
- ethernet interface: 10/100 Mbps (RJ45)
- ethernet protocols: Ethernet II
- protection class: Class II IP20
- color: white

Consisting of:

- Uponor Smatrix Pulse com R-208
- adaptor for DIN rail installations
- RJ45 connection cable (2m)
- first step instructions, safety instructions
- mounting material



Item no.	Frequency MHz	l mm	b mm	d mm	Qty 2	Qty 1	UOM
1093030	868	110	21	110	16	1	pce

Uponor Smatrix Base / Style

Uponor Smatrix Base controller Pulse X-245 BUS 6X

- compatible to Uponor Smatrix Base controller Pulse X-245 Bus 6X
- protection class: Class II IP20
- color: white

Consisting of:

- Uponor Smatrix Base controller Pulse X-245 Bus 6X
- first step instructions, safety instructions
- mounting material



Item no.	OV V	l mm	b mm	d mm	Qty 2	Qty 1	UOM
1093017	230	340	110	55	4	1	pce

Uponor Smatrix Base slave module Pulse M-242 BUS 6X

- 6 channel slave module for Uponor Smatrix Base controller Pulse X-245 Bus 6X
- supports up to 6 room thermostats and 6 actuators
- click-in installation
- protection class: IP20
- color: white



Item no.	l mm	b mm	d mm	Qty 2	Qty 1	UOM
1093134	141	110	55	16	1	pce

Uponor Smatrix Base star module Pulse M-243 BUS 6X

- 6 channel star module for Uponor Smatrix Base controller Pulse X-245 Bus 6X
- flexible wiring approaches possible (star topology)
- supports up to 6 room thermostats
- protection class: IP20
- color: white



Item no.	l mm	b mm	d mm	Qty 2	Qty 1	UOM
1093135	141	110	55	16	1	pce

Uponor Smatrix Base / Style

Uponor Smatrix Base thermostat D+RH Style T-149 Bus

- measures and displays the perceived room temperature and relative humidity
- protection class: IP30
- color: white RAL9016

Functions:

- heating or cooling demand indication
- RH measured value
- comfort / ECO indication
- ECO setback modification
- manual H/C switchover function
- cooling allowed function (room by room)
- displays celsius or fahrenheit
- operating modes: room temperature (RT), internal with floor max/min (RFT), remote sensor (RS), remote outdoor (RO)
- temperature calibration
- optional: floor sensor can be connected

Consisting of:

- Uponor Smatrix Base thermostat D+RH Style T-149 Bus
- mounting material

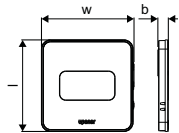

Item no.	l mm	b mm	w mm	Qty 2	Qty 1	UOM
1087813	80	9	81	180	1	pce

Uponor Smatrix Base / Style

Uponor Smatrix Base thermostat D+RH Style T-149 Bus

- measures and displays the perceived room temperature and relative humidity
- protection class: IP30
- color: black

Functions:

- heating or cooling demand indication
- RH measured value
- comfort / ECO indication
- ECO setback modification
- manual H/C switchover function
- cooling allowed function (room by room)
- displays celsius or fahrenheit
- operating modes: room temperature (RT), internal with floor max/min (RFT), remote sensor (RS), remote outdoor (RO)
- temperature calibration
- optional: floor sensor can be connected

Consisting of:

- Uponor Smatrix Base thermostat D+RH T-149 Bus
- mounting material

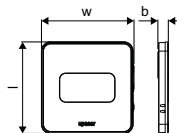

Item no.	Dimension	l	w	Qty 2	Qty 1	UOM
		mm	mm			
1087814	BLACK	80	81	180	1	pce

Uponor Smatrix Base / Style

Uponor Smatrix Base timer I-143 Bus

- set time start up wizard
- holiday mode
- comfort/ECO indication
- manual H/C switchover function
- 6 pre-programmed schedules
- 1 freely programmable schedule
- ECO setback value setting
- clock reset
- timer functions
- Autobalancing de-/activation
- backlight
- displays software version on start-up
- protection class: IP30
- color: white glossy

Consisting of:

- Uponor Smatrix Base timer I-143 Bus
- mounting material



Item no.	Dimension	l mm	b mm	d mm	Qty 2	Qty 1	UOM
1086978	RAL9016	80	80	26,5	75	1	pce

Uponor Smatrix Base thermostat P+RH T-148 Bus

- measures and displays the perceived room temperature and relative humidity
- protection class: IP30
- color: white glossy

Functions:

- heating or cooling demand indication
- RH limit indication
- individual night setback
- set time start up wizard
- 6 pre-programmed schedules
- 1 freely programmable schedule
- cooling allowed function (room by room)
- displays celsius or fahrenheit
- operating modes: room temperature (RT), internal with floor max/min (RFT), remote sensor (RS), remote outdoor (RO)
- display with backlight (dims 10 seconds after last button event)
- displays software version (on power-up)
- optional: floor or outdoor sensor can be connected

Consisting of:

- Uponor Smatrix Base thermostat Prog.+RH T-148 Bus
- mounting material



Item no.	Dimension	l mm	b mm	d mm	Qty 2	Qty 1	UOM
1086977	RAL9016	80	80	26,5	75	1	pce

Uponor Smatrix Base / Style

Uponor Smatrix Base thermostat D T-146 Bus

- measures and displays the perceived room temperature
- protection class: IP30
- color: white glossy

Functions:

- heating or cooling demand indication
- cooling allowed function (room by room)
- displays celsius or fahrenheit
- operating modes: room temperature (RT), internal with floor max/min (RFT), remote sensor (RS), remote outdoor (RO)
- mode reception from timer
- night set back
- backlight (dims 10 seconds after last button event)
- displays software version (on power-up)
- optional: floor sensor can be connected

Consisting of:

- Uponor Smatrix Base thermostat digital T-146 Bus
- mounting material



Item no.	Dimension	l mm	b mm	d mm	Qty 2	Qty 1	UOM
1086976	RAL9016	80	80	26,5	75	1	pce

Uponor Smatrix Base thermostat standard T-145 Bus POD

- measures perceived room temperature
- protection class: IP30
- color: white glossy

Functions:

- light indication behind dial after changing the set point
- heating/cooling demand indication
- dip switch to enable/disable timer function if timer installed
- optional: enable/disable timer function

Consisting of:

- Uponor Smatrix Base thermostat standard T-145 Bus POD
- mounting material



Item no.	Dimension	l mm	b mm	d mm	Qty 2	Qty 1	UOM
1086975	RAL9016	80	80	26,5	75	1	pce

Uponor Smatrix Base / Style

Uponor Smatrix Base thermostat flush T-144 Bus

- measures perceived room temperature
- designed for in-wall box installation including frame
- different frames can be used for installation in a switch rail frame
- protection class: IP30
- color: white glossy

Functions:

- heating/cooling demand indication
- dip switch to enable/disable timer function if timer installed

Consisting of:

- Uponor Smatrix Base thermostat flush T-144 Bus
- mounting material
- outer frame



Item no.	Dimension	l mm	b mm	d mm	Qty 2	Qty 1	UOM
1086973	RAL9016	81,5	81,5	41,7	60	1	pce

Uponor Smatrix Base thermostat public T-143 Bus

- measures perceived room temperature
- protection class: IP30
- color: white glossy

Functions:

- potentiometer on rear side to adjust setpoint temperature
- tamper detector
- dry contact input for forced ECO via e.g. SMS module or BMS
- dry contact input for heating/cooling changeover
- dip switch for function/sensor selection
- optional: floor, outdoor or remote sensor can be connected

Consisting of:

- Uponor Smatrix Base thermostat public T-143 Bus
- mounting material



Item no.	Dimension	l mm	b mm	d mm	Qty 2	Qty 1	UOM
1086972	RAL9016	80	80	26,5	75	1	pce

Uponor Smatrix Base / Style

Uponor Smatrix Base wallframe Style T-149 A-14X

- T-149 surface adaptor for on-wall installation
- incl. mounting material
- color: white RAL9016

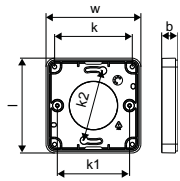

Item no.	l mm	b mm	k mm	k1 mm	k2 mm	w mm	Qty 2	Qty 1	UOM
1087821	79	14	65	60	60	79	90	1	pce

Uponor Smatrix Base wallframe Style T-149 A-14X

- T-149 surface adaptor for on-wall installation
- incl. mounting material
- color: black

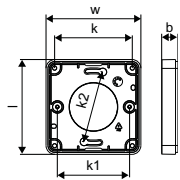

Item no.	Dimension	l mm	b mm	k mm	k1 mm	k2 mm	w mm	Qty 2	Qty 1	UOM
1087822	BLACK	79	14	65	60	60	79	90	1	pce

Uponor Smatrix wallframe T-X A-1XX

- wallframe for Uponor Smatrix thermostats
- color: white glossy (RAL9016)



Item no.	Dimension	l mm	h mm	d mm	Qty 2	Qty 1	UOM
1086986	RAL9016	90	90	2,1	250	1	pce

Uponor Smatrix Base / Style

Uponor Smatrix Base bus cable A-145

- 4-wire bus cable allows to connect Uponor Smatrix Base / Base PRO devices
- 2 wires for power supply / 2 wires for data transmission
- shielding: aluminium/polyester foil with tracer strand
- temperature range: -20°C ... +80°C
- cross section: AWG22
- sheath: PVC
- rated voltage: 400VAC/DC



Item no.	Dimension	L m	Qty 2	Qty 1	UOM
1071670	50m	50	2	1	pce

Uponor Smatrix floor/remote sensor S-1XX

- can be combined with Uponor Smatrix Wave/Base(Pro) thermostats
- can be used as floor or remote sensor
- length: 3m
- sensor type: NTC 10kOhm at 25°C



Item no.	L m	Qty 2	Qty 1	UOM
1071684	3	63	1	pce

Uponor Smatrix relay module H/C M-1XX

- interface to a heating/cooling source
- switch over H/C between Uponor Smatrix and H/C source
- incl. socket for DIN rail mounting, manual, mounting material
- contact: 2 change-over (CO)
- Ucoil: 24VDC
- test voltage: 5kV
- protection class: IP40
- switching voltage: 380VAC, 125VDC
- switching current: 5A@250VAC, 5A@30VDC
- contact material: Ag+Au plated
- temperature range: -40°C...+70°C



Item no.	Dimension	OV I V	b mm	d mm mm	Qty 2	Qty 1	UOM
1083576	24V	24	85,5	16 70,5	84	1	pce

Uponor Smatrix Base / Style

Uponor Smatrix relay module H/C M-1XX

- interface to a heating/cooling source
- switch over H/C between Uponor Smatrix and H/C source
- incl. socket for DIN rail mounting, manual, mounting material, wall box
- contact: 2 change-over (CO)
- Ucoil: 230VAC
- test voltage: 5kV
- protection class: IP40
- switching voltage: 380VAC, 125VDC
- switching current: 5A@250VAC, 5A@30VDC
- contact material: Ag+Au plated
- temperature range: -40°C...+70°C



Item no.	Dimension	OV V	I mm	b mm	d mm	Qty 2	Qty 1	UOM
1083577	230V	230	85,5	16	70,5	16	1	pce

Uponor Smatrix actuator retrofit set A-XXX

- 24V actuator retrofit set
 - incl. 3 bayonet manifold valve adaptor rings, mounting instructions
 - interface between existing third-party manifolds and Uponor Smatrix control system
 - compatible to 80% of existing third-party manifolds
 - open/closed indicator
 - NC (normally closed) = closes without power
 - first open function
 - Autobalancing functionality for new and retrofit installations
 - temperature range: 0°C...60°C
 - height: 58mm + adaptor ring
 - color: blue
- adaption list can be found at: www.uponor.com/download-centre
- stroke length: 5mm
 - connection cable: 2x 0.75mm² x 1m
 - Ucoil: 24V/50Hz
 - Pcoil: 1W
 - diameter: 44.3mm



Item no.	Dimension	d mm	OV V	P W	h mm	Qty 2	Qty 1	UOM
1083575	24V, NC, 1W	44	24	~ 1	58	100	1	set

Uponor Smatrix Base / Style

Uponor Vario PLUS actuator NC

- open/closed indicator
- operation at ambient temperature of up to +60°C
- protection class: IP54



Item no.	Dimension	d mm	AG mm	OV V	P W	h mm	Qty 2	Qty 1	UOM
NEW 1000138	24V MT30x1,5	40	30x1,5	24	~2	54	10	1	pce

Uponor Vario S actuator NC

- open/closed indicator
- operation at ambient temperature of up to +60°C
- protection class: IP54



Item no.	Dimension	d mm	IG mm	OV V	P W	h mm	Qty 2	Qty 1	UOM
NEW 1013008	24V NC FT30x1,5	40	30x1,5	24	~2	56	10	1	pce

Uponor Base

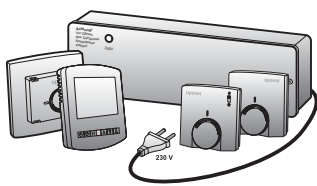

An economical 230V room controls system for radiant heating that is simple to install and use. A common wiring method and controls logic that is familiar and easy to work with.

Your benefits

- Standard 230V wiring
- Wide selection of thermostats
- Easy to install and use
- Common wiring method and controls logic
- Easy integration to standard on/off time control



Specification

- 230V standard wiring
- common wiring method and controls logic
- easy integration to standard on/off time control
- optional: pump logic

Application

- wired room temperature control for radiant heating

Certification

- CE

Uponor Base controller X-23

- supports up to 6 thermostats (230V)
- supports up to 14 actuators (230V)
- overload protection
- power: 10VA
- protection class: IP40

Options:

- Uponor Base pump relay X-23 (sold separately 1058427)

Consisting of:

- Uponor Base controller X-23
- mounting material



Item no.	Dimension	OV V	I mm	b mm	d mm	Qty 2	Qty 1	UOM
1058426	6X 230V	230	310	90	65	200	1	pce

Uponor Base

Uponor Base pump relay X-23

- pump logic
- pump exercise (daily 5 minutes) to prevent jamming
- overload protection
- power: 3VA
- protection class: IP40

Consisting of:

- Uponor Base pump relay X-23
- mounting material



03.21

Item no.	Dimension	OV V	l mm	b mm	Qty 1	UOM
1058427	230V	230	310	90	1	pce

Uponor Base flexiboard X-24

- supports up to 6 thermostats (230V)
- supports up to 12 actuators (230V)
- rotary channel selector switch for quick actuator assignment
- overload protection
- power: 10VA
- protection class: IP40

Consisting of:

- Uponor Base flexiboard X-24
- mounting material



Item no.	Dimension	OV V	l mm	b mm	d mm	Qty 1	UOM
1088331	6X 230V	230	368	90	65	1	pce

Uponor Base flexiboard with pump logic X-25

- supports up to 6 thermostats (230V)
- supports up to 12 actuators (230V)
- rotary channel selector switch for quick actuator assignment
- pump relay 2A (230V)
- overload protection
- power: 10VA
- protection class: IP40

Consisting of:

- Uponor Base flexiboard with pump logic X-25 6X
- mounting material



Item no.	Dimension	OV V	l mm	b mm	d mm	Qty 1	UOM
1089086	6X 230V	230	368	90	65	1	pce

Uponor Base

Uponor Base flexiboard X-26

- supports up to 8 thermostats (230V)
- supports up to 12 actuators (230V)
- rotary channel selector switch for quick actuator assignment
- overload protection
- power: 10VA
- protection class: IP40

Consisting of:

- Uponor Base flexiboard X-26 8X
- mounting material



Item no.	Dimension	OV V	I mm	b mm	d mm	Qty 1	UOM
1089087	8X 230V	230	368	90	65	1	pce

Uponor Base flexiboard with pump logic X-27

- supports up to 8 thermostats (230V)
- supports up to 12 actuators (230V)
- rotary channel selector switch for quick actuator assignment
- pump relay 2A (230V)
- overload protection
- power: 10VA
- protection class: IP40

Consisting of:

- Uponor Base flexiboard with pump logic X-27 8X
- mounting material



Item no.	Dimension	OV V	I mm	b mm	d mm	Qty 1	UOM
1089088	8X 230V	230	368	90	65	1	pce

Uponor Base thermostat standard T-23

- printed scale on dial thermostat
- simple on/off control (bimetall)
- setting range can be limited mechanically by moving pins under the dial
- powered by base unit (Uponor Base controller X-23)
- setpoint range: +5°C ... +30°C
- wire: 4x 1.5mm²
- max. cable length: 100m
- protection class: IP30
- color: RAL 9010



Item no.	Dimension	OV V	I mm	b mm	d mm	colour	Qty 2	Qty 1	UOM
1058422	230V RAL9010	230	78	78,5	13,9	RAL 9010	160	1	pce

Uponor Base

Uponor Base thermostat flush T-24

- printed scale on dial thermostat for flush installation
- simple on/off control (bimetall)
- setting range can be limited mechanically by moving pins under the dial
- powered by base unit (Uponor Base controller X-23)
- setpoint range: +5°C ... +30°C
- wire: 4x 1.5mm²
- max. cable length: 100m
- protection class: IP30
- color: pure white, glossy

Consisting of:

- Uponor Base thermostat flush T-24 230V
- outer frame 81x85x44.5mm
- cover 50x50mm



Item no.	Dimension	OV V	l mm	b mm	d mm	Qty 1	UOM
1058423*	230V	230	81	85	44,5	1	pce

Uponor Base thermostat H/C T-25

- printed scale on dial thermostat
- simple on/off control (bimetall)
- heating/cooling changeover (2-pipe installation)
- setting range can be limited mechanically by moving pins under the dial
- powered by base unit (Uponor Base controller X-23)
- wire: 4x 1.5mm²
- max. cable length: 100m
- protection class: IP30
- color: ~RAL9010

Consisting of:

- Uponor Base thermostat H/C T-25 230V
- DIP switch for changeover contact heating/cooling



Item no.	Dimension	OV V	l mm	b mm	d mm	Qty 1	UOM
1058424*	230V	230	78	78,5	13,9	1	pce

Uponor Base wallframe T-23/25

Item no.	Qty 1	UOM
1087268	1	pce

Uponor Base

Uponor Base thermostat dig. prog. T-26

- in-side port for floor/remote sensor connection
- fully programmable - 5/2 or 7 day with four heat levels per day
- multiple regulation control choice - air only, floor only, air and floor
- holiday mode with override feature
- optimised start
- lock facility - tamper proof setting
- status display on current thermostat mode
- powered by base unit (Uponor Base controller X-23)
- optional: remote sensor (sold seperatly 1047459)
- setpoint range: +5°C ... +35°C
- protection class: IP20
- color: ~RAL9010



Item no.	Dimension	OV V	l mm	b mm	d mm	colour	Qty 1	UOM
1058425	230V RAL9010	230	85	98	13	RAL 9010	1	pce

Uponor Base sensor remote

- remote sensor for T-26 or thermostat 1047457
- for min/max floor temperature
- length: 3m



Item no.	Dimension	L m	Qty 1	UOM
1047459	230V	3	1	pce

Uponor Vario PLUS actuator NC

- open/closed indicator
- operation at ambient temperature of up to +60°C
- protection class: IP54



Item no.	Dimension	d mm	AG mm	OV V	P W mm	h mm	Qty 2	Qty 1	UOM
NEW 1005605	230V MT30x1,5	40	30x1,5	230	~2	54	10	1	pce

Uponor Vario S actuator NC

- open/closed indicator
- operation at ambient temperature of up to +60°C
- protection class: IP54



Item no.	Dimension	d mm	IG mm	OV V	P W mm	h mm	Qty 2	Qty 1	UOM
NEW 1013006	230V NC FT30x1,5	40	30x1,5	230	~2	56	10	1	pce

Uponor Smatrix

Uponor Smatrix transformer A-1XX

- sparepart power supply for Uponor Smatrix Wave/Base(Pro) controller
- incl. mounting material
- can be either clicked into the Uponor Smatrix controller or mounted beside
- protection class: IP20
- secondary voltage: 24V AC (50VA)
- additional conformity: EAC
- color: grey



Item no.	l mm	h mm	d mm	Qty 2	Qty 1	UOM
1071677	110	97	55	12	1	pce

Uponor Smatrix actuator retrofit set A-XXX

- 24V actuator retrofit set
- incl. 3 bayonet manifold valve adaptor rings, mounting instructions
- interface between existing third-party manifolds and Uponor Smatrix control system
- compatible to 80% of existing third-party manifolds
- open/closed indicator
- NC (normally closed) = closes without power
- first open function
- Autobalancing functionality for new and retrofit installations
- temperature range: 0°C...60°C
- height: 58mm + adaptor ring
- color: blue
- adaption list can be found at: www.uponor.com/download-centre
- stroke length: 5mm
- connection cable: 2x 0.75mm² x 1m
- Ucoil: 24V/50Hz
- Pcoil: 1W
- diameter: 44.3mm



Item no.	Dimension	d mm	OV V	P W	h mm	Qty 2	Qty 1	UOM
1083575	24V, NC, 1W	44	24	~ 1	58	100	1	set

Uponor Smatrix

Uponor Smatrix relay module H/C M-1XX

- interface to a heating/cooling source
- switch over H/C between Uponor Smatrix and H/C source
- incl. socket for DIN rail mounting, manual, mounting material
- contact: 2 change-over (CO)
- Ucoil: 24VDC
- test voltage: 5kV
- protection class: IP40
- switching voltage: 380VAC, 125VDC
- switching current: 5A@250VAC, 5A@30VDC
- contact material: Ag+Au plated
- temperature range: -40°C...+70°C



Item no.	Dimension	OV V	l mm	b mm	d mm	Qty 2	Qty 1	UOM
1083576	24V	24	85,5	16	70,5	84	1	pce

Uponor Smatrix relay module H/C M-1XX

- interface to a heating/cooling source
- switch over H/C between Uponor Smatrix and H/C source
- incl. socket for DIN rail mounting, manual, mounting material, wall box
- contact: 2 change-over (CO)
- Ucoil: 230VAC
- test voltage: 5kV
- protection class: IP40
- switching voltage: 380VAC, 125VDC
- switching current: 5A@250VAC, 5A@30VDC
- contact material: Ag+Au plated
- temperature range: -40°C...+70°C



Item no.	Dimension	OV V	l mm	b mm	d mm	Qty 2	Qty 1	UOM
1083577	230V	230	85,5	16	70,5	16	1	pce

Uponor Smatrix floor/remote sensor S-1XX

- can be combined with Uponor Smatrix Wave/Base(Pro) thermostats
- can be used as floor or remote sensor
- length: 3m
- sensor type: NTC 10kOhm at 25°C



Item no.	L m	Qty 2	Qty 1	UOM
1071684	3	63	1	pce

Uponor Smatrix

Uponor Smatrix wallframe T-X A-1XX

- wallframe for Uponor Smatrix thermostats
- color: white glossy (RAL9016)



Item no.	Dimension	l mm	h mm	d mm	Qty 2	Qty 1	UOM
1086986	RAL9016	90	90	2,1	250	1	pce

Uponor Comfort E



Uponor Comfort E for your personal heating moments
Imagine your feet touch a warm ground when you get out of bed in the morning or after having a shower. Easy to realise with Comfort E flatt sew-up 3mm Cable Mat

under tiles and Comfort E flatt Aluminium-Foil Mat under laminate or parquet with Uponor AL-Foil Insulation below. Uponor Comfort E Thermostats keep track of your heating time and cost.

Your benefits

- Ideal for renovation and new build
- Fits for tiles, laminate, parquet or vinyl covering in dry and wet floor constructions
- Easy to installation for low floor height
- Highest comfort with short reaction time
- Keep track of your heating costs with programmable control units



Specification

- thermostat with floor sensor

Application

- Electrical radiant direct reacting floor heating
- embedded in leveling compound or tile adhesive under tiles or
- to be laid directly on an insulation layer under suitable floorings like parquet, laminate or carpet

Thermostats:

- temperature range: +5°C ... +30°C
- 230V

Certification

- CE, EAC
- VDE 40046886 Cable Mat

Uponor Comfort E WET-cable mat

Specification

- Electrical radiant roll out cable heating mats
- embedded in leveling compound or tile adhesive under tiles
- fully surfaced self-adhesive mats
- 0,5m wide
- sew up 3mm cable
- shielded double core heating cable
- 4m connecting cable
- FEP electrical isolated heating conductor
- incl. protection tube for the floor sensor

Application

- Electrical radiant direct reacting floor heating
- embedded in leveling compound or tile adhesive under tiles

Certification

- CE, EAC
- VDE 40046886
- IPX7

Uponor Comfort E

Uponor Comfort E cable mat

- heating capacity 160 W/m²



Item no.	Dimension	Resistance Ohm	Q W	L m	B m	A m ²	Qty 2	Qty 1	UOM
1088656	160-1	326	160	2	0,5	1	50	1	set
1088657	160-1,5	224	240	3	0,5	1,5	50	1	set
1088658	160-2	163	320	4	0,5	2	50	1	set
1088659	160-2,5	133	400	5	0,5	2,5	50	1	set
1088660	160-3	110	480	6	0,5	3	50	1	set
1088661	160-4	78	640	8	0,5	4	35	1	set
1088662	160-5	67	800	10	0,5	5	35	1	set
1088663	160-6	53	960	12	0,5	6	35	1	set
1088664	160-7	45	1120	14	0,5	7	20	1	set
1088665	160-8	41	1280	16	0,5	8	20	1	set
1088666	160-10	32	1600	20	0,5	10	20	1	set
1088667	160-12	28	1920	24	0,5	12	20	1	set

Uponor Comfort E cable mat

- heating capacity 100 W/m²



Item no.	Dimension	Resistance Ohm	Q W	L m	B m	A m ²	Qty 2	Qty 1	UOM
1093461	100-1	498	100	2	0,5	1	50	1	set
1093462	100-1,5	328	150	3	0,5	1,5	50	1	set
1093463	100-2	259	200	4	0,5	2	50	1	set
1093464	100-2,5	202	250	5	0,5	2,5	50	1	set
1093465	100-3	161	300	6	0,5	3	50	1	set
1093466	100-4	125	400	8	0,5	4	35	1	set
1093467	100-5	98	500	10	0,5	5	35	1	set
1093468	100-6	84	600	12	0,5	6	35	1	set
1093469	100-7	77	700	14	0,5	7	20	1	set
1093470	100-8	61	800	16	0,5	8	20	1	set
1093471	100-10	53	1000	20	0,5	10	20	1	set
1093472	100-12	42	1200	24	0,5	12	20	1	set

Uponor Comfort E WET-cable

Specification

- Electrical radiant single heating cable
- embedded in leveling compound or tile adhesive under tiles
- 3mm cable
- shielded double core heating cable
- 4m connecting cable
- FEP electrical isolated heating conductor
- incl. protection tube for the floor sensor
- incl. tape coil to fix the cable

Application

- Electrical radiant direct reacting floor heating
- embedded in leveling compound or tile adhesive under tiles

Certification

- CE, EAC
- IPX7

Uponor Comfort E

Uponor Comfort E cable



Item no.	Dimension	Resistance Ohm	Qty 2	Qty 1	UOM
1093451	150W 13m	353	88	1	set
1093452	300W 25m	176	88	1	set
1093453	460W 37m	115	88	1	set
1093454	700W 54m	76	88	1	set
1093455	930W 75m	57	88	1	set
1093456	1100W 87m	48	56	1	set
1093457	1550W 124m	34	56	1	set
1093458	1850W 143m	29	56	1	set

Uponor Comfort E cable rail

- cable clamp track in metal to fix Comfort E single cable
- 25 m
- c/c 2,5 cm



Item no.	Qty 2	Qty 1	UOM
1093460	20	1	pce

Uponor Comfort E DRY

Specification

- Electrical radiant AL-Foil roll out heating mats
- to be laid directly on an insulation layer under suitable floorings like parquet, laminate or carpet
- AL-foil on both sides
- 0,5m wide
- FEP electrical isolated double core heating conductor
- 3m connecting cable
- incl. AL-adhesive strips
- incl. protection tube for the floor sensor

Application

- Electrical radiant direct reacting floor heating
- to be laid directly on an insulation layer under suitable floorings like parquet, laminate or carpet

Certification

- CE, EAC
- IPX7

Uponor Comfort E

Uponor Comfort E AL-foil mat

- heating capacity 140 W/m²



Item no.	Dimension	Resistance Ohm	Q W	L m	B m	A m ²	Qty 2	Qty 1	UOM
1088684	140-1	378	140	2	0,5	1	50	1	set
1088685	140-2	189	280	4	0,5	2	50	1	set
1088686	140-3	126	420	6	0,5	3	50	1	set
1088687	140-4	94	560	8	0,5	4	35	1	set
1088688	140-5	76	700	10	0,5	5	50	1	set
1088689	140-6	63	840	12	0,5	6	50	1	set
1088690	140-7	54	980	14	0,5	7	35	1	set
1088691	140-8	47	1120	16	0,5	8	35	1	set
1088692	140-9	42	1260	18	0,5	9	35	1	set
1088693	140-10	38	1400	20	0,5	10	35	1	set

Uponor Comfort E AL-foil insulation

- Insulation board to reduce heat loss of the Uponor Comfort E AL-Foil Mat
- 5mm folded XPS panels
- ~0,15m²K/W



Item no.	Dimension	l mm	b mm	Qty 2	Qty 1	UOM
1088707	5mm	625	800	200	5	m ²

Uponor Comfort E Controls

Specification

- 230V

Application

- Controls units for Electrical radiant direct reacting floor heating
- for cable mats
- for AL-foil mats

Certification

- CE, EAC

Uponor Comfort E thermostat dial set T-85

- Dial Thermostat Set T-85 for Uponor electrical radiant heating with floor sensor
- Surface mounting directly on conduit box
- On / Off switch
- Temperature range 5 - 30°C
- Switching current 16A
- Protection class of housing IP30



Item no.	Dimension	Qty 1	UOM
1088705	230V	1	set

Uponor Comfort E

Uponor Comfort E thermostat dig.prog. flush Set T-86

- Digital Programmable Thermostat Set T-86 for Uponor electrical radiant heating with floor sensor
- Flush mounted in wall
- Current mode status display
- Energy saving function
- Standard holiday mode
- Temperature range 5 - 35°C
- Switching current 16A
- Protection class of housing IP20



Item no.	Dimension	Qty 1	UOM
1088819	230V	1	set

Uponor Comfort E cable R-Set

- Repair set for Uponor Comfort E Cable Mat and AL-Foil Mat
- 3 sleeves
- 4 shrink hoses



Item no.	Dimension	Qty 2	Qty 1	UOM
1090942	230V	20	1	set

Uponor Comfort E protective tube

- Corrugated tube to protect floor sensor of electrical Underfloor Heating
- 2m corrugated tube
- Fixed metal sleeve on one side



Item no.	Qty 2	Qty 1	UOM
1090943	100	1	pce

Uponor Comfort E floor sensor T-85, T-87

- Substitute 4m floor sensor for
- Uponor Comfort E Thermostat dial Set T-85
- Uponor Comfort E Thermostat dig.prog. flush Set T-87IF 230V



Item no.	Qty 2	Qty 1	UOM
1090944	100	1	pce

Uponor Ecoflex Thermo

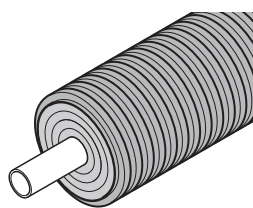

Uponor Ecoflex Thermo pipes, certified based on European Standard EN 15632, are for heating and cooling applications. Single pipes are for projects with large flow requirements.

Thermo Twin offers supply

and return pipes in one jacket. The pipes have long coil lengths and high flexibility for good installation and energy efficiency.

Your benefits

- Excellent flexibility
- Good energy efficiency
- Reliable: 30 years of proven performance
- Can be ordered in specified lengths
- Full range of fittings and accessories
- Certified system



Specification

- Flexible, pre-insulated, self-compensating plastic pipe system produced based on EN 15632
- Medium pipe: cross-linked polyethylene (PE-Xa) pipe based on EN ISO 15875, natural coloured, PN 6 (SDR 11) or PN 10 (SDR 7,4), Oxygen tightness based on EN 15632
- Insulating material: closed-cell PE-X foam, permanently elastic, ageing-resistant
- Casing pipe: Corrugated polyethylene (HDPE)

Application

- Transport of heating and cooling water for buried installations.
- Heating operating temperature 80°C based on EN 15632
- Malfunction temperature 95°C
- Static verification for heavy traffic load of 60 tons

Certification

- Approvals should be checked by local responsible person

Uponor Ecoflex Thermo Single

- Heating and Cooling
- One medium pipe PE-Xa with oxygen barrier, SDR 11
- Max. load 6 bar / 95°C
- PEX foam, HDPE casing

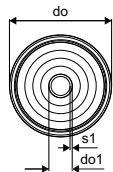

Item no.	Dimension	do mm	do1 mm	s1 mm	R m	R m	Weight kg	Qty 1	UOM
1018109	25x2,3/140	140	25	2,3	0,25	0,25	1,18	200	m
1018110	32x2,9/140	140	32	2,9	0,30	0,30	1,31	200	m
1018111	40x3,7/175	175	40	3,7	0,35	0,35	2,20	200	m
1018112	50x4,6/175	175	50	4,6	0,45	0,45	2,40	200	m
1018113	63x5,8/175	175	63	5,8	0,55	0,55	2,80	200	m
1018114	75x6,8/200	200	75	6,8	0,80	0,80	3,74	100	m
1018115	90x8,2/200	200	90	8,2	1,10	1,10	4,20	100	m
1018116	110x10,0/200	200	110	10	1,20	1,20	5,24	100	m
1083868	125x11,4/250	250	125	11,4	1,40	1,40	7,25	120	m

Uponor Ecoflex Thermo

Uponor Ecoflex Thermo Single PN10

- Heating and Cooling
- One medium pipe PE-Xa with oxygen barrier, SDR 7,4
- Max. load 10 bar / 95°C
- PEX foam, HDPE casing
- Production in Russia / Make to order / Please ask about delivery time

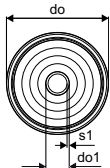

Item no.	Dimension	do mm	do1 mm	s1 mm	R m	Weight kg	Qty 1	UOM
1045877	40x5,5/175	175	40	5,5	0,45	2,40	200	m
1045878	50x6,9/175	175	50	6,9	0,55	2,70	200	m
1045879	63x8,6/175	175	63	8,6	0,65	3,20	200	m
1061041	75x10,3/200	200	75	10,3	0,90	4,00	100	m
1061042	90x12,3/200	200	90	12,3	1,20	4,50	100	m
1061043	110x15,1/200	200	110	15,1	1,30	5,50	100	m

Uponor Ecoflex Thermo Twin

- Heating and Cooling
- Two medium pipes PE-Xa with oxygen barrier, SDR 11
- Max. load 6 bar / 95°C
- Coloured centre profil to avoid confusion of flow and return line
- PEX foam, HDPE casing

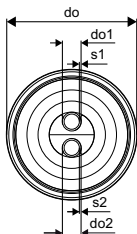

Item no.	Dimension	do mm	do1 mm	do2 mm	s1 mm	s2 mm	R m	R m	Weight kg	Qty 1	UOM
1018134	2x25x2,3/175	175	25	25	2,3	2,3	0,50	0,5	2,20	200	m
1018135	2x32x2,9/175	175	32	32	2,9	2,9	0,60		2,40	200	m
1018136	2x40x3,7 /175	175	40	40	3,7	3,7	0,80		2,60	200	m
1018137	2x50x4,6/200	200	50	50	4,6	4,6	1,00		3,50	100	m
1018138	2x63x5,8/200	200	63	63	5,8	5,8	1,20		4,55	100	m
1088276	2x75x6,8/250	250	75	75	6,8	6,8	1,40		6,50	100	m

Uponor Ecoflex Thermo Mini

- Heating and Cooling
- One medium pipe PE-Xa with oxygen barrier, SDR 11
- Max. load 6 bar / 95°C
- PEX foam, HDPE casing

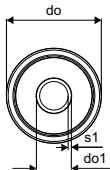

Item no.	Dimension	do mm	do1 mm	s1 mm	R m	Weight kg	Qty 2	Qty 1	UOM
1018132	25x2,3/68	68	25	2,3	0,2	0,50		200	m
1018133	32x2,9/68	68	32	2,9	0,25	0,55		200	m

Uponor Ecoflex Varia

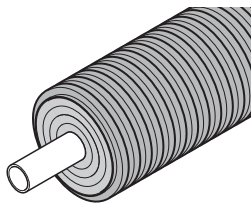

Uponor Ecoflex Varia pipes, certified to European Standard EN 15632, are for heating and cooling applications with reduced outer diameter requirements. Varia Single is for projects that demand large flow

capacity. Varia Twin has supply and return pipes in one jacket. The pipes have long coil lengths and high flexibility for good installation efficiency.

Your benefits

- Superb flexibility
- Good installation economy
- Can be ordered in specified lengths
- Reliable: 30 years of proven performance
- Full range of fittings and accessories
- Certified system



Specification

- Flexible, pre-insulated, self-compensating plastic pipe system produced based on EN 15632
- Medium pipe: cross-linked polyethylene (PE-Xa) pipe based on EN ISO 15875, natural coloured, PN 6 (SDR 11) or PN 10 (SDR 7,4), Oxygen tightness based on EN 15632
- Insulating material: closed-cell PE-X foam, permanently elastic, ageing-resistant
- Casing pipe: Corrugated polyethylene (HDPE)

Application

- Transport of heating and cooling water for buried installations.
- Heating operating temperature 80°C based on EN 15632
- Malfunction temperature 95°C
- Static verification for heavy traffic load of 60 tons

Certification

- Approvals should be checked by local responsible person

Uponor Ecoflex Varia Single

- Heating and Cooling
- One medium pipe PE-Xa with oxygen barrier, SDR 11
- Max. load 6 bar / 95°C
- PEX foam, HDPE casing

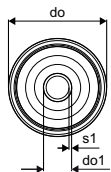

Item no.	Dimension	do mm	do1 mm	s1 mm	R m	Weight kg	Qty 1	UOM
1018230	25x2,3 /90	90	25	2,3	0,25	1,02	200	m
1018231	32x2,9 /90	90	32	2,9	0,30	1,12	200	m
1018232	40x3,7 /140	140	40	3,7	0,35	1,47	200	m
1018233	50x4,6 /140	140	50	4,6	0,40	1,67	200	m
1018234	63x5,8 /140	140	63	5,8	0,50	1,97	200	m
1018235	75x6,8 /175	175	75	6,8	0,60	2,72	200	m
1018236	90x8,2 /175	175	90	8,2	0,70	3,14	100	m
1018237	110x10,0 /175	175	110	10	0,90	4,14	100	m
1062886	125x11,4/200	200	125	11,4	1,40	5,00	120	m

Uponor Ecoflex Varia

Uponor Ecoflex Varia Twin

- Heating and Cooling
- Two medium pipe PE-Xa with oxygen barrier, SDR 11
- Max. load 6 bar / 95°C
- Coloured centre profil to avoid confusion of flow and return line
- PEX foam, HDPE casing

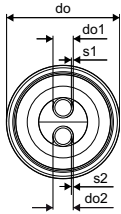

Item no.	Dimension	do mm	do1 mm	do2 mm	s1 mm	s2 mm	R m	Weight kg	Qty 1	UOM
1018238	2x25x2,3/140	140	25	25	2,3	2,3	0,40	1,36	200	m
1018239	2x32x2,9/140	140	32	32	2,9	2,9	0,50	1,43	200	m
1018240	2x40x3,7/140	140	40	40	3,7	3,7	0,70	2,08	200	m
1018241	2x50x4,6/175	175	50	50	4,6	4,6	0,90	2,84	200	m

Uponor Ecoflex Aqua

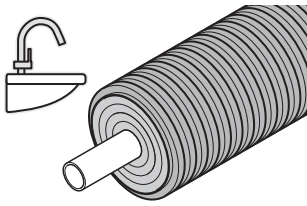

Uponor Ecoflex Aqua pipes are a reliable choice for hygienic and energy-efficient distribution of warm tap water in buried installations. Aqua pipes come in two versions: single pipe for large flow capacity or when one supply

line is sufficient; twin pipe with supply and circulating pipe in the same jacket.

Your benefits

- Clean and hygienic
- Excellent flexibility
- Ease of installation
- Good heat loss performance
- Reliable: 30 years of proven performance
- Full range of accessories and fittings



Specification

- Flexible, pre-insulated, self-compensating plastic pipe system.
- Medium pipe: cross-linked polyethylene (PE-Xa) pipe based on EN ISO 15875, natural coloured, PN 10 (SDR 7,4)
- Insulating material: closed-cell PE-X foam, permanently elastic, ageing-resistant
- Casing pipe: Corrugated polyethylene (HDPE)

Application

- Transport of warm tap water for buried installations.
- Tap water operating temperature 70°C based on EN 15875
- Malfunction temperature 95°C
- Static verification for heavy traffic load of 60 tons

Certification

- Approval should be checked by local responsible person

Uponor Ecoflex Aqua Single

- Warm tap water
- One medium pipe PE-Xa, SDR 7,4
- Max. load 10 bar / 95°C
- PEX foam, HDPE casing

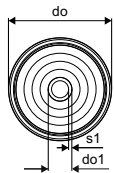

Item no.	Dimension	do mm	do1 mm	s1 mm	R m	Weight kg	Qty 1	UOM
1018117	25x3,5/140	140	25	3,5	0,35	1,24	200	m
1018118	32x4,4/140	140	32	4,4	0,40	1,42	200	m
1018119	40x5,5/175	175	40	5,5	0,45	2,40	200	m
1018120	50x6,9/175	175	50	6,9	0,55	2,70	200	m
1018121	63x8,6/175	175	63	8,6	0,65	3,20	200	m
1018122	75x10,3/200	200	75	10,3	0,90	4,34	100	m
1018123	90x12,3/200	200	90	12,3	1,20	5,30	100	m
1036036	110x15,1/200	200	110	15,1	1,30	6,50	100	m

Uponor Ecoflex Aqua

Uponor Ecoflex Aqua Twin

- Warm tap water with circulation
- Two medium pipe PE-Xa, SDR 7,4
- Max. load 10 bar / 95°C
- PEX foam, HDPE casing
- Coloured centre profil to avoid confusion of supply and circulation

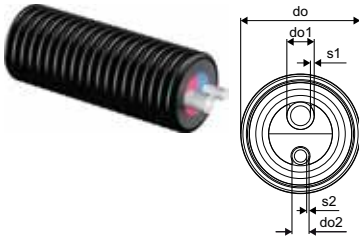

Item no.	Dimension	do mm	do1 mm	do2 mm	s1 mm	s2 mm	R m	Weight kg	Qty 1	UOM
1084885	25x3,5-20x2,8/140	140	25	20	3,5	2,8	0,65	1,75	200	m
1018139	25x3,5-25x3,5/175	175	25	25	3,5	3,5	0,65	2,05	200	m
1084886	32x4,4-20x2,8/175	175	32	20	4,4	2,8	0,70	2,40	200	m
1018140	32x4,4-25x3,5/175	175	32	25	4,4	3,5	0,70	2,20	200	m
1018141	40x5,5-25x3,5/175	175	40	25	5,5	3,5	0,90	2,45	200	m
1044015	40x5,5-32x4,4/175	175	40	32	5,5	4,4	0,90	2,80	200	m
1018142	50x6,9-25x3,5/175	175	50	25	6,9	3,5	1,00	2,73	200	m
1034188	50x6,9-32x4,4/175	175	50	32	6,9	4,4	1,00	3,10	200	m
1044016	50x6,9-40x5,5/200	200	50	40	6,9	5,5	1,00	3,50	100	m
1044013	50x6,9-50x6,9/200	200	50	50	6,9	6,9	1,00	3,60	100	m

Uponor Ecoflex Quattro

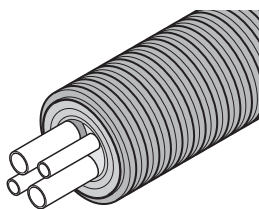

Uponor Ecoflex Quattro is an all-in-one pipe solution for all requirements: extensive supply networks or a single connection to one building. It provides heating, warm tap water supply and circulation pipes in the same jacket: two

flow pipes are intended for domestic warm water and the other two for heating.

Your benefits

- Cost efficient, all-in-one installation
- Energy efficient
- Easy to install: very flexible
- Corrosion resistant
- Reliable: 30 years of proven performance
- Full range of fittings and accessories



Specification

- Flexible, pre-insulated, self-compensating plastic pipe system
- Medium pipe: Cross-linked polyethylene (PE-Xa) pipe based on EN ISO 15875, natural coloured, PN 6 (SDR 11) and PN10 (SDR 7,4), Oxygen tightness based on EN 15632 for heating pipes
- Insulating material: closed-cell PE-X foam, permanently elastic, ageing-resistant
- Casing pipe: Corrugated polyethylene (HDPE)

Application

- Transport of heating and warm tap water for buried installations.
- Heating operating temperature 80°C based on EN 15632
- Tap water operating temperature 70°C based on EN ISO 15875
- Malfunction temperature 95°C
- Static verification for heavy traffic load of 60 tons

Certification

- Approvals should be checked by local responsible person

Uponor Ecoflex Quattro

Uponor Ecoflex Quattro

- Heating and warm tap water with circulation
- Four medium pipe PE-Xa, SDR 11 and 7,4
- Max. load 6 bar heating / 10 bar tap water / 95°C
- PEX foam, HDPE casing
- Coloured centre profil to avoid confusion between the lines

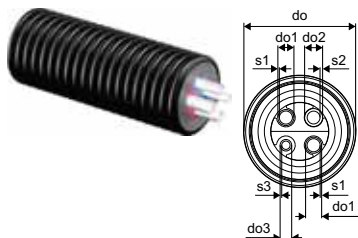

Item no.	Dimension	do mm	do1 mm	do2 mm	do3 mm	s1 mm	s2 mm	s3 mm	R m	R m	Weight kg	Qty 1	UOM
1084887	2x25x2,3-25x3,5-20x2,8/175	175	25	25	20	2,3	3,5	2,8	0,80		2,30	200	m
1018147	2x25x2,3-2x25x3,5/175	175	25	25	25	2,3	3,5	3,5	0,80		2,41	200	m
1084888	2x32x2,9-25x3,5-20x2,8/175	175	32	25	20	2,9	3,5	2,8	0,80		2,50	200	m
1018148	2x32x2,9-2x25x3,5/175	175	32	25	25	2,9	3,5	3,5	0,80		2,64	200	m
1084889	2x32x2,9-32x4,4-20x2,8/175	175	32	32	20	2,9	4,4	2,8	0,80	0,8	2,90	200	m
1018149	2x32x2,9-32x4,4-25x3,5/175	175	32	32	25	2,9	4,4	3,5	0,80		2,78	200	m
1044018	2x32x2,9-2x32x4,4/175	175	32	32	32	2,9	4,4	4,4	0,80		2,90	200	m
1084891	2x40x3,7-32x4,4-20x2,8/200	200	40	32	20	3,7	4,4	2,8	1,00	1	3,50	100	m
1084890	2x40x3,7-40x5,5-25x3,5/200	200	40	40	25	3,7	5,5	3,5	1,00		3,60	100	m
1044019	2x40x3,7-2x40x5,5/200	200	40	40	40	3,7	5,5	5,5	1,00		3,80	100	m

Uponor Ecoflex Quattro Midi

- Heating and warm tap water with circulation
- Four medium pipe PE-Xa, SDR 11 and 7,4
- Max. load 6 bar heating / 10 bar tap water / 95°C
- PEX foam, HDPE casing
- One marked heating pipe to avoid confusion of flow and return line

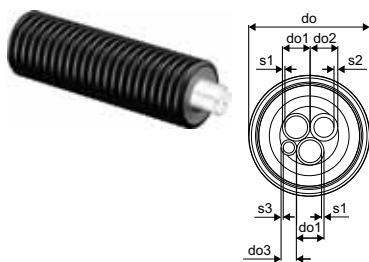

Item no.	Dimension	do mm	do1 mm	do2 mm	do3 mm	s1 mm	s2 mm	s3 mm	R m	Weight kg	Qty 1	UOM
1086836	2x25x2,3-25x3,5-20x2,8/140	140	25	25	20	2,3	3,5	2,8	0,65	1,84	200	m
1086837	2x32x2,9-25x3,5-20x2,8/140	140	32	25	20	2,9	3,5	2,8	0,7	2,00	200	m

Uponor Ecoflex Supra

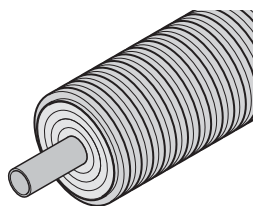

Uponor Ecoflex Supra is designed for cold potable water applications and chilled water distribution for cooling systems. The Uponor Ecoflex Supra Pipes are ideal to deliver cold water to holiday resorts, hotel complexes or industrial facilities.

Your benefits

- Clean and hygienic
- Easy to install and very flexible
- Corrosion resistant
- Reliable: 30 years of proven performance
- Full range of fittings and accessories



Specification

- Flexible, pre-insulated, self-compensating plastic pipe system
- Medium pipe: Polyethylene PE 100, PN 16 (SDR 11) black with blue layer and new in PE100 RC, PN 16 (SDR 11) black with blue stripes
- Insulating material: closed-cell PE-X foam, permanently elastic, ageing-resistant
- Casing pipe: Corrugated polyethylene (HDPE)

Application

- Transport of cold potable or cooling water for buried installations.
- Operating temperature +20°C
- Static verification for heavy traffic load of 60 tons

Certification

- Approvals should be checked by local responsible person

Uponor Ecoflex Supra

- Cold potable water and cooling
- One medium pipe PE 100 RC black, SDR 11
- Max. load 16 bar / 20°C
- PEX foam, HDPE casing

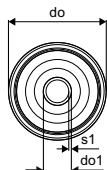

Item no.	Dimension	do mm	do1 mm	s1 mm	R m	Weight kg	Qty 1	UOM
1095722	25x2,3/68	68	25	2,3	0,3	0,52	200	m
1095723	32x2,9/68	68	32	2,9	0,4	1,47	200	m
1095724	40x3,7/140	140	40	3,7	0,5	1,47	200	m
1095725	50x4,6/140	140	50	4,6	0,6	1,67	200	m
1095726	63x5,8/140	140	63	5,8	0,7	1,97	200	m
1095727	75x6,8/175	175	75	6,8	0,9	2,72	150	m
1095728	90x8,2/175	175	90	8,2	1	3,14	100	m
1095729	110x10,0/200	200	110	10	1,2	5,24	100	m

Uponor Wipex

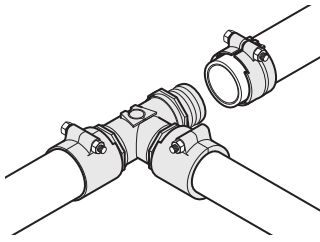

This joining technology connects cross-linked polyethylene pipes for hot and cold water in domestic and district heating installations. The coupling is available in pipe dimensions 25-125mm in two series: PN

6 and PN 10. The coupler is sealed with an O-ring in 25-110mm and with hemp in 125mm, for quick, reliable installation.

Your benefits

- Easy to install without hemp
- Corrosion resistant
- Clean and hygienic
- Reliable
- Made of high-quality DR brass



Specification

- Wipex fittings in corrosion-resistant brass, dezincification based on EN ISO 6509 with stainless steel screw.
- O-ring sealing between Wipex coupling and base fitting connectors
- Bolt set for couplers include a hex socket bolt in stainless steel and the nut as well as washer from brass
- Pre-open sleeve design with assembled support part for the dimension 63-110mm.

Application

- Fittings for pipe systems Thermo, Aqua, Quattro, Supra, Supra PLUS and Supra Standard
- Connection of PE and PE-Xa medium pipe to couplers with cylindrical inch male thread
- Max. operating temperature 95°C

Certification

- Approvals should be checked by local responsible person

Uponor Wipex coupling PN6

- Connection of PE-Xa or PE pipe
- 6 bar, SDR 11
- Cylindric thread G" for O-ring sealing
- DR = dezincification resistance brass

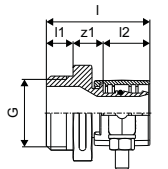

Item no.	Dimension	l	l1	l2	G	z1	p	Weight	Qty 2	Qty 1	UOM
		mm	mm	mm	inch	mm	bar	kg			
1018328	25x2,3-G1	47	12	21	1	14	6	0,20	40	1	pce
1018329	32x2,9-G1	52	12	26	1	14	6	0,30	20	1	pce
1018330	40x3,7-G1 1/4	61	16	30	1 1/4	15	6	0,50	10	1	pce
1018331	50x4,6-G1 1/4	68	16	37	1 1/4	16	6	0,70	10	1	pce
1018332	63x5,8-G2	84	20	47	2	18	6	1,20	8	1	pce
1018333	75x6,8-G2	92	20	51	2	21	6	1,50	6	1	pce
1018334	90x8,2-G3	105	24	60	3	22	6	2,40	4	1	pce
1018335	110x10,0-G3	118	24	72	3	22	6	3,50	3	1	pce

Uponor Wipex

Uponor Ecoflex coupling PN6

- Connection of PE-Xa or PE pipe
- 6 bar, SDR 11
- Cylindric thread R", hemp sealing
- Cannot be used with Wipex fittings!
- DR = dezincification resistance brass

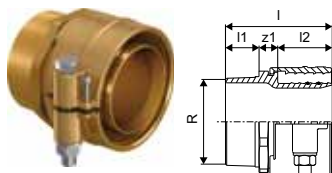

Item no.	Dimension	l	l1	l2	G	R	z1	p	Weight	Qty 1	UOM
		mm	mm	mm	inch	inch	mm	bar	kg		
1078368	125x11,4-R4	137	43	70	3/4	4	24	6	5,24	1	pce

Uponor Wipex coupling PN10

- Connection of PE-Xa or PE pipe
- 10 bar, SDR 7,4
- Cylindric thread G" for O-ring sealing
- DR = dezincification resistance brass

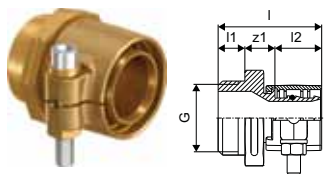

Item no.	Dimension	l	l1	l2	G	z1	p	Weight	Qty 2	Qty 1	UOM
		mm	mm	mm	inch	mm	bar	kg			
1018336	25x3,5-G1	47	12	21	1	14	10	0,20	40	1	pce
1018338	32x4,4-G1	52	12	26	1	14	10	0,30	20	1	pce
1018339	40x5,5-G1 1/4	61	16	30	1 1/4	16	10	0,50	10	1	pce
1018340	50x6,9-G1 1/4	68	16	37	1 1/4	16	10	0,70	10	1	pce
1018341	63x8,6-G2	84	20	46	2	18	10	1,20	8	1	pce
1018342	75x10,3-G2	92	20	51	2	21	10	1,50	6	1	pce
1018343	90x12,3-G3	105	24	59	3	22	10	2,40	4	1	pce
1023170	110x15,1-G3	118	24	72	3	22	10	3,20	3	1	pce

Uponor Wipex jointing equal PN6

- Connection of PE-Xa or PE pipe
- 6bar, SDR 11
- DR = dezincification resistance brass

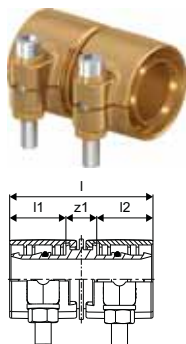

Item no.	Dimension	l	l1	l2	z1	p	Weight	Qty 2	Qty 1	UOM
		mm	mm	mm	mm	bar	kg			
1042972	25x2,3-25x2,3	54	21	21	12	6	0,18	30	1	pce
1042973	32x2,9-32x2,9	63	26	26	12	6	0,34	25	1	pce
1042980	40x3,7-40x3,7	71	29	29	13	6	0,54	15	1	pce
1042984	50x4,6-50x4,6	85	36	36	13	6	0,99	10	1	pce
1042981	63x5,8-63x5,8	105	46	46	13	6	1,53	5	1	pce
1042985	75x6,8-75x6,8	123	51	51	22	6	2,27	3	1	pce
1042986	90x8,2-90x8,2	142	59	59	24	6	3,50	4	1	pce
1042987	110x10-110x10	166	71	71	24	6	4,82	2	1	pce

Uponor Wipex

Uponor Ecoflex coupling PN6

- Connection of PE-Xa or PE pipe
- 6 bar, SDR 11
- DR = dezincification resistance brass

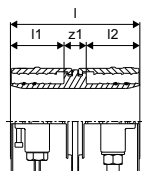

Item no.	Dimension	l mm	l1 mm	l2 mm	z1 mm	p bar	Weight kg	Qty 1	UOM
1078365	125x11,4-125x11,4	169	70	70	29	6	8,15	1	pce

Uponor Wipex jointing equal PN10

- Connection of PE-Xa or PE pipe
- 10 bar, SDR 7,4
- DR = dezincification resistance brass

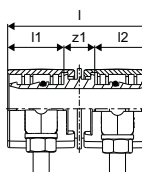

Item no.	Dimension	l mm	l1 mm	l2 mm	z1 mm	p bar	Weight kg	Qty 2	Qty 1	UOM
1042970	25x3,5-25x3,5	54	21	21	12	10	0,18	40	1	pce
1042974	32x4,4-32x4,4	64	26	26	12	10	0,34	25	1	pce
1042979	40x5,5-40x5,5	72	30	29	13	10	0,54	15	1	pce
1042983	50x6,9-50x6,9	86	37	36	13	10	0,96	10	1	pce
1042982	63x8,6-63x8,6	106	47	46	13	10	0,16	4	1	pce

Uponor Wipex tee

- Cylindric thread G" with sealing ring
- 6 bar, SDR 11 / 10 bar, SDR 7,4
- DR = dezincification resistance brass

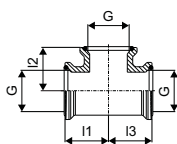

Item no.	Dimension	l1 mm	l2 mm	l3 mm	G inch	G1 inch	G2 inch	p bar	Weight kg	Qty 2	Qty 1	UOM
1018345	G1-G1-G1	35	35	35	1	1	1	6+10	0,31	20	1	pce
1018346	G1 1/4-G1 1/4-G1 1/4	42	42	42	1 1/4	1 1/4	1 1/4	6+10	0,48	10	1	pce
1018347	G2-G2-G2	55	55	55	2	2	2	6+10	1,01	4	1	pce
1018348	G3-G3-G3	75	75	75	3	3	3	6+10	2,64	3	1	pce

Uponor Wipex

Uponor Ecoflex tee

- Conical thread R", hemp sealing
- 6 bar, SDR 11 / 10 bar, SDR 7,4
- DR = dezincification resistance brass

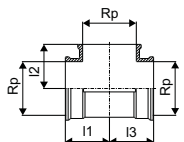

Item no.	Dimension	l1 mm	l2 mm	l3 mm	Rp inch	p bar	Weight kg	Qty 1	UOM
1078367	Rp4-Rp4-Rp4	91	91	91	4	6	3,96	1	pce

Uponor Wipex elbow

- Cylindric thread G" with sealing ring
- 6 bar, SDR 11 / 10 bar, SDR 7,4
- DR = dezincification resistance brass

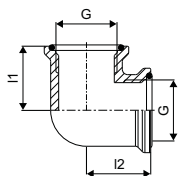

Item no.	Dimension	l1 mm	l2 mm	G inch	G1 inch	p bar	Weight kg	Qty 2	Qty 1	UOM
1018350	G1-G1	35	35	1	1	6+10	0,27	20	1	pce
1018351	G1 1/4-G1 1/4	42	42	1 1/4	1 1/4	6+10	0,45	15	1	pce
1018352	G2-G2	55	55	2	2	6+10	0,94	5	1	pce
1018353	G3-G3	75	75	3	3	6+10	2,20	2	1	pce

Uponor Ecoflex elbow

- Conical thread R", hemp sealing
- 6 bar, SDR 11 / 10 bar, SDR 7,4
- DR = dezincification resistance brass

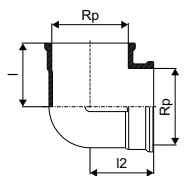

Item no.	Dimension	l1 mm	l2 mm	Rp inch	p bar	Weight kg	Qty 1	UOM
1078366	Rp4-Rp4	92	92	4	6	3,28	1	pce

Uponor Wipex

Uponor Wipex sleeve

- Cylindric thread G" with sealing ring
- 6 bar, SDR 11 / 10 bar, SDR 7,4
- DR = dezincification resistance brass

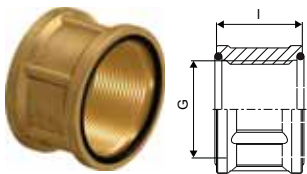

Item no.	Dimension	l mm	G inch	p bar	Weight kg	Qty 2	Qty 1	UOM
1018355	G1-G1	30	1	6+10	0,19	40	1	pce
1018356	G1 1/4-G1 1/4	37	1 1/4	6+10	0,21	25	1	pce
1018357	G2-G2	45	2	6+10	0,42	15	1	pce
1018358	G3-G3	55	3	6+10	0,88	10	1	pce

Uponor Wipex reducer male x female

- Cylindric thread G" with sealing ring
- 6 bar, SDR 11 / 10 bar, SDR 7,4
- DR = dezincification resistance brass

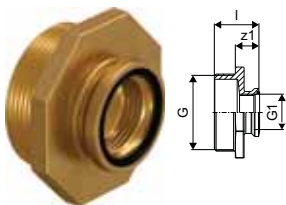

Item no.	Dimension	l mm	G inch	G1 inch	z1 mm	p bar	Weight kg	Qty 2	Qty 1	UOM
1018368	G1 1/4-G1	36	1 1/4	1	20	6+10	0,23	25	1	pce
1018369	G1 1/2-G1 1/4	39	1 1/2	1 1/4	21	6+10	0,24	25	1	pce
1018371	G2-G1	41	2	1	21	6+10	0,39	15	1	pce
1018372	G2-G1 1/4	45	2	1 1/4	25	6+10	0,40	15	1	pce
1018373	G2 1/2-G2	48	2 1/2	2	26	6+10	0,65	6	1	pce
1018374	G3-G1	47	3	1	23	6+10	0,87	6	1	pce
1018375	G3-G1 1/4	51	3	1 1/4	27	6+10	0,88	10	1	pce
1018376	G3-G2	55	3	2	31	6+10	0,89	10	1	pce
1009052	G4-G3	58	4	3	30	6+10	1,46	6	1	pce

Uponor Ecoflex reducer male x female

- Outer conical thread R", hemp sealing
- Inner cylindric thread G" with sealing ring
- 6 bar, SDR 11 / 10 bar, SDR 7,4
- DR = dezincification resistance brass

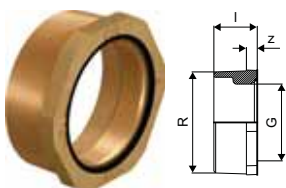

Item no.	Dimension	l mm	G inch	R inch	z mm	p bar	Weight kg	Qty 2	Qty 1	UOM
1078369	R4-G3	48	3	4	12	6	1,40	6	1	pce

Uponor Wipex

Uponor Wipex flange

- Cylindric thread G" with sealing ring
- 6 bar, SDR 11 / 10 bar, SDR 7,4
- DR = dezincification resistance brass

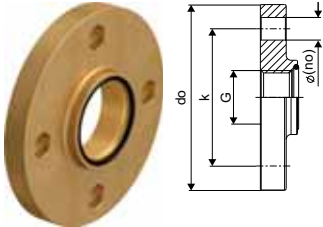

Item no.	Dimension	no. pce	do mm	G inch	k mm	p bar	Weight kg	Qty 2	Qty 1	UOM
1018359*	F25/4-85/G1	4	115	1	85	6+10	1,30	10	1	pce
1018360*	F32/4-100/G1 1/4	4	140	1 1/4	100	6+10	2,00	5	1	pce
1018361	F40/4-110/G1 1/2	4	150	1 1/2	110	6+10	2,42	5	1	pce
1018362*	F50/4-125/G2	4	165	2	125	6+10	3,04	4	1	pce
1018363	F65/8-145/2 1/2	8	185	2 1/2	145	6+10	3,74	3	1	pce
1018364*	F80/8-160/G3	8	200	3	160	6+10	4,21	3	1	pce
1018365	F100/8-180/G4	8	220	4	180	6+10	4,55	3	1	pce

Uponor Ecoflex flange

- Conical thread R", hemp sealing
- 6 bar, SDR 11 / 10 bar, SDR 7,4
- Stainless steel



Item no.	Dimension	no. pce	l mm	Rp inch	z mm	k mm	p bar	Weight kg	Qty 1	UOM
1078370*	F100/8-180/Rp4	8	40	4	20	180	6	4,50	1	pce

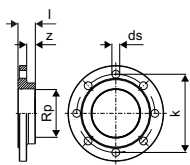

Uponor Wipex

Uponor Wipex swivel union

- Rotatable double nipple
- Cylindric thread G" for O-ring sealing
- 6 bar, SDR 11 / 10 bar, SDR 7,4
- DR = dezincification resistance brass

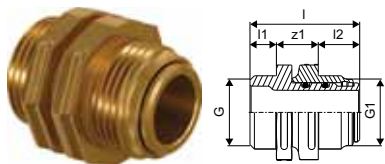

Item no.	Dimension	l mm	l1 mm	l2 mm	G inch	G1 inch	z1 mm	p bar	Weight kg	Qty 2	Qty 1	UOM
1045455	G1	50	12	19	1	1	19	6+10	0,26	20	1	pce
1045456	G1 1/4-G1	50	12	21	1	1 1/4	17	6+10	0,35	20	1	pce
1045457	G1 1/4	58	16	21	1 1/4	1 1/4	21	6+10	0,50	15	1	pce
1045458	G2-G1 1/4	68	16	25	1 1/4	2	27	6+10	2,00	10	1	pce
1045459	G2	74	20	25	2	2	29	6+10	1,17	10	1	pce
1045460	G3-G2	82	24	25	3	2	33	6+10	1,79	3	1	pce
1045461	G3	89	24	30	3	3	35	6+10	2,75	2	1	pce

Uponor Wipex fix point bushing

- Cylindric thread G" with sealing ring
- 6 bar, SDR 11 / 10bar, SDR 7,4
- DR = dezincification resistance brass

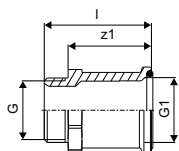

Item no.	Dimension	l mm	G inch	G1 inch	z1 mm	p bar	Weight kg	Qty 2	Qty 1	UOM
1018302*	G1	54	1	1	42	6+10	0,23	30	1	pce
1018303	G1 1/4	84	1 1/4	1 1/4	68	6+10	0,45	10	1	pce
1018304	G2	93	2	2	73	6+10	0,78	5	1	pce
1018305*	G3	135	3	3	111	6+10	2,15	5	1	pce

Uponor Wipex adapter S-Press PN6

- Connetion of PE-Xa pipe to Uponor MLC pipe.
- 6 bar
- DR = dezincification resistance brass

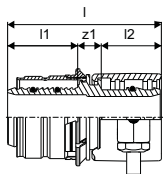

Item no.	Dimension	l mm	l1 mm	l2 mm	do mm	s mm	z1 mm	p mm	Weight kg	Qty 2	Qty 1	UOM
1060058	32x2,9-32x3,0	66	30	26	15	2,5	10	6	0,24	25	1	pce

Uponor Wipex

Uponor Wipex adapter S-Press PN6

- Connection of PE-Xa pipe to Uponor MLC pipe.
- 6 bar
- DR = dezincification resistance brass

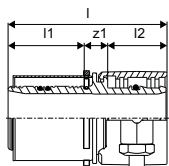

Item no.	Dimension	l	l1	l2	do	s	z1	p	Weight	Qty 2	Qty 1	UOM
		mm	mm	mm	mm	mm	mm	bar	kg			
1060059	40x3,7-40x4,0	79	38	30	18	2,5	12	6	0,41	15	1	pce
1060060	50x4,6-50x4,5	86	38	37	18	2,5	12	6	0,66	10	1	pce

Uponor Wipex RS adapter PN6

- RS = unique modular fitting connection
- 6 bar, SDR 11
- DR = dezincification resistance brass

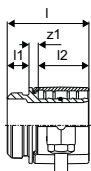

Item no.	Dimension	l	l1	l2	z1	p	Weight	Qty 2	Qty 1	UOM
		mm	mm	mm	mm	bar	kg			
1047013	DR 63x5,8 RS2	75	46	20	9	6	0,94	240	1	pce
1047014	DR 75x6,8 RS2	84	46	20	18	6	1,28	240	1	pce
1047015	DR 90x8,2 RS3	93	59	20	14	6	2,07	180	1	pce
1047016	DR 110x10,0 RS3	105	71	20	14	6	2,67	180	1	pce

Uponor Wipex RS adapter PN10

- RS = unique modular fitting connection
- 10 bar, SDR 7,4
- DR = dezincification resistance brass

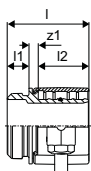

Item no.	Dimension	l	l1	l2	z1	p	Weight	Qty 2	Qty 1	UOM
		mm	mm	mm	mm	bar	kg			
1047017	DR 63x8,6 RS2	75	20	46	9	10	0,95	240	1	pce
1047018	DR 75x10,3 RS2	83	20	51	12	10	1,33	240	1	pce
1047019	DR 90x12,3 RS3	92	20	59	13	10	2,21	180	1	pce
1047020	DR 110x15,1 RS3	104	20	71	13	10	3,01	180	1	pce

Uponor Wipex sleeve plier

- Expansion tool for the WIPEX coupling sleeve



Item no.	Dimension	l	Weight	Qty 2	Qty 1	UOM
		mm	kg			
1046407	1 - 1 1/2	145	0,15	25	1	pce
1046408	1 1/2 - 3 1/2	200	0,23	25	1	pce

Uponor Wipex

Uponor RS adapter PL Q&E

- RS
- Positive listed brass
- Uponor Q&E Ring must be ordered separately

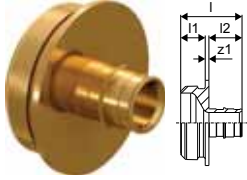

Item no.	Dimension	l	l1	l2	z1	p	Qty 2	Qty 1	UOM
		mm	mm	mm	mm	mm bar			
1047021	25-RS2	50	20	27	3	6+10	480	1	pce
1047022	32-RS2	57	20	34	3	6+10	480	1	pce
1047023	40-RS2	65	20	42	3	6+10	480	1	pce
1047024	50-RS2	75	20	52	3	6+10	400	1	pce

Uponor RS adapter PL Q&E

- RS
- Positive listed brass
- Uponor Q&E Ring must be ordered separately

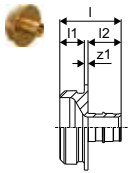

Item no.	Dimension	l	l1	l2	z1	p	Qty 2	Qty 1	UOM
		mm	mm	mm	mm	mm bar			
1047026	63-RS2	88	20	65	3	6+10	400	1	pce

Uponor RS coupling

- Made of tin-plated brass
- Base part for all RS2 or RS3 inserts including 2 lock pins.

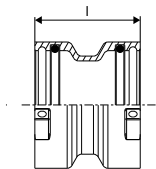

Item no.	Dimension	l	Qty 2	Qty 1	UOM
		mm			
1029144	RS2-RS2	58	480	1	pce
1029145	RS3-RS3	58	480	1	pce

Uponor RS tee

- Made of tin-plated brass
- Base part for all RS2 or RS3 inserts including 3 lock pins.

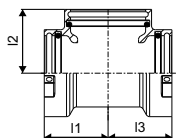

Item no.	Dimension	l1	l2	l3	Qty 2	Qty 1	UOM
		mm	mm	mm			
1029142	RS2-RS2-RS2	51	51	51	336	1	pce
1029143	RS3-RS3-RS3	68	68	68	175	1	pce

Uponor Wipex

Uponor RS elbow

- Made of tin-plated brass
- Base part for all RS2 or RS3 inserts including 2 lock pins.

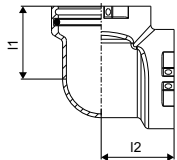

Item no.	Dimension	l1 mm	l2 mm	Qty 2	Qty 1	UOM
1029138	RS2-RS2	51	51	336	1	pce
1029139	RS3-RS3	68	68	240	1	pce

Uponor RS elbow 45°

- Made of tin-plated brass
- Base part for all RS2 or RS3 inserts including 2 lock pins.

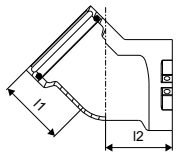

Item no.	Dimension	l1 mm	l2 mm	Qty 2	Qty 1	UOM
1029140	RS2-RS2	51	51	336	1	pce
1029141	RS3-RS3	68	68	175	1	pce

Uponor RS reducer

- Made of tin-plated brass
- Reducer from RS3 to RS2 including 1 lock pin.

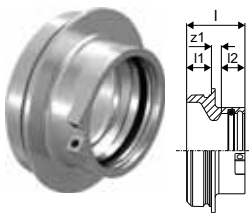

Item no.	Dimension	l mm	l1 mm	l2 mm	z1 mm	Qty 2	Qty 1	UOM
1029146	RS3-RS2	47	20	19	8	480	1	pce

Uponor RS adapter female thread

- Made of tin-plated brass.
- its to all RS2 or RS3 base parts

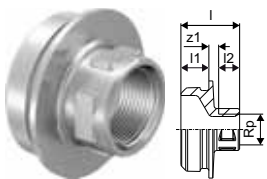

Item no.	Dimension	l mm	l1 mm	l2 mm	Rp inch	z1 mm	Qty 2	Qty 1	UOM
1029134	Rp1"FT-RS2	45	20	19	1	6	480	1	pce
1029135	Rp2"FT-RS2	54	20	26	2	8	480	1	pce
1029136	Rp2 1/2"FT-RS2	63	20	30	2 1/2	12	480	1	pce
1029137	Rp3"FT-RS3	65	20	33	3	12	240	1	pce

Uponor Wipex

Uponor RS adapter male thread

- Made of tin-plated brass
- Fits to all RS2 or RS3 base parts

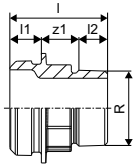

Item no.	Dimension	l	l1	l2	R	z1	Qty 2	Qty 1	UOM
		mm	mm	mm	inch	mm			
1029131	R2"MT-RS2	66	20	23	2	23	480	1	pce
1029132	R2 1/2"MT-RS2	63	20	27	2 1/2	16	480	1	pce
1029133	R3"MT-RS3	73	20	30	3	23	240	1	pce

Uponor RS flange adapter

- Made of tin-plated brass
- Fits to all RS2 or RS3 base parts
- Flange PN6/PN16 acc. to EN 1092-3
- Bolt circle with 4/8 holes.

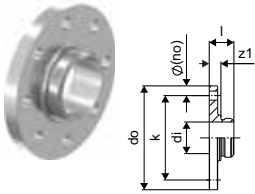

Item no.	Dimension	l	di	do	z1	k	p	Qty 2	Qty 1	UOM
		mm	mm	mm	mm	mm	bar			
1029129	RS3-DN80 (PN16)	45	78,1	200	25	160	16	90	1	pce
1029130	RS3-DN100 (PN16)	44	78,1	220	24	180	16	90	1	pce

Uponor RS spacer

- Made of tin-plated brass
- Spacer to connect RS base parts of equal dimensions e.g to create T-manifold or shift in distribution lines.

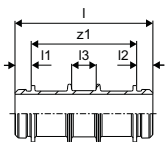

Item no.	Dimension	l	l1	l2	l3	z1	Qty 2	Qty 1	UOM
		mm	mm	mm	mm	mm			
1046477	RS2-RS2 l=130mm	170	20	20	30	130	240	1	pce
1046478	RS3-RS3 l=210mm	250	20	20	30	210	96	1	pce

Uponor Wipex

Uponor RS spacer

- Made of tin plated-brass
- Spacer to connect RS base parts of equal dimensions.

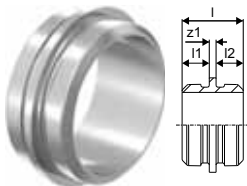

Item no.	Dimension	l mm	l1 mm	l2 mm	z1 mm	Qty 2	Qty 1	UOM
1046750	RS2-RS2 l=5mm	45	20	20	5	480	1	pce
1046751	RS3-RS3 l=5mm	45	20	20	5	240	1	pce

Uponor RS adapter S-Press

- Made of tin-plated brass
- Fits to all RS2 or RS3 base parts.

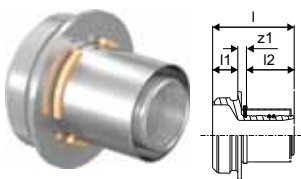

Item no.	Dimension	l mm	l1 mm	l2 mm	z1 mm	Qty 2	Qty 1	UOM
1046940	40-RS2	65	20	38	7	480	1	pce
1046941	50-RS2	65	20	38	7	480	1	pce
1029125	63-RS2	88	20	61	7	400	1	pce
1029126	75-RS2	88	20	61	7	400	1	pce
1029127	90-RS3	93	20	62	11	240	1	pce
1029128	110-RS3	93	20	62	11	240	1	pce

Uponor RS lock pin

- made of plastic
- to lock the RS insert to the RS base part.



Item no.	Dimension	colour	Qty 2	Qty 1	UOM
1042921	RS2 black	black	5000	10	pce
1042922	RS3 grey	grey		10	pce

Uponor Q&E

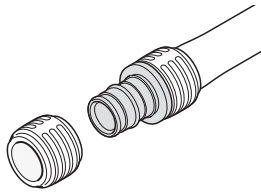

Uponor Q&E is a unique and innovative fittings system that uses the shrink-back effect of cross-linked polyethylene PE-Xa pipes for quick and easy installation. A wide range of fittings and accessories makes Q&E a

complete and secure system for cost-effective installation. Corrosion resistance makes it safe, secure and watertight.

Your benefits

- Fast and reliable mounting
- Corrosion resistant
- Low pressure loss
- Ergonomic design of ring
- Easy identification of ring dimension



Certification

- Approvals should be checked by local responsible person

Uponor Q&E evolution ring white

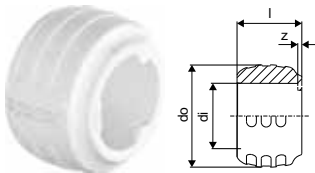

Item no.	Dimension	l mm	di mm	do mm	z mm	p mm bar	colour -	Qty 2	Qty 1	UOM
1057455	25	25	25,3	34,6	1	6+10	white	300	20	pce
1057456	32	32	32,4	41,8	1	6+10	white	150	10	pce

Uponor Q&E ring with stop edge natural

- With stop edge
- Pex material

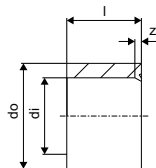

Item no.	Dimension	l mm	di mm	do mm	z mm	p mm bar	colour -	Qty 2	Qty 1	UOM
1045464	40	41	40,8	50,2	3	6+10	natural	80	5	pce
1045489	50	50	51	63	4	6+10	natural	70	5	pce
1045490	63	63	64,3	75,7	4	6+10	natural	35	5	pce
1085087	75	76	76,3	88,3	4	6+10	natural	18	2	pce

Uponor Q&E elbow PPSU

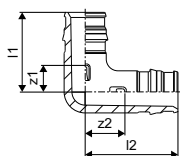

Item no.	Dimension	l1 mm	l2 mm	z1 mm	z2 mm	p mm bar	Qty 2	Qty 1	UOM
1008681	25-25	42	47	14	19	6+10	25	5	pce
1001245	32-32	53	59	18	23	6+10	15	1	pce
1008683	40-40	65	74	21	29	6+10	10	1	pce
1042859	50-50	83	98	29	44	6+10	5	1	pce
1042858	63-63	100	112	33	44	6+10	3	1	pce
1085080	75-75	149	149	64	65	6+10	2	1	pce

Uponor Q&E

Uponor Q&E coupling PPSU

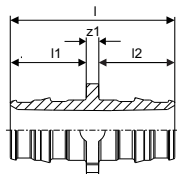

Item no.	Dimension	l mm	l1 mm	l2 mm	z1 mm	p bar	Qty 2	Qty 1	UOM
1008671	25-25	58	28	28	3	6+10	50	5	pce
1001235	32-32	73	35	35	3	6+10	20	1	pce
1008673	40-40	90	44	44	3	6+10	10	1	pce
1042866	50-50	113	54	54	5	6+10	10	1	pce
1042865	63-63	141	68	68	6	6+10	5	1	pce
1085084	75-75	179	86	86	7	6+10	10	1	pce

Uponor Q&E reducer PPSU

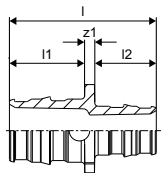

Item no.	Dimension	l mm	l1 mm	l2 mm	z1 mm	p bar	Qty 2	Qty 1	UOM
1001240	32-25	66	28	35	3	6+10	20	1	pce
1008678	40-32	82	35	44	3	6+10	10	1	pce
1042879	50-32	94	54	35	5	6+10	10	1	pce
1042867	50-40	103	54	44	5	6+10	10	1	pce
1042878	63-40	117	68	44	6	6+10	5	1	pce
1042877	63-50	128	68	54	6	6+10	5	1	pce
1085086	75-50	147	86	54	6	6+10	10	1	pce
1085085	75-63	160	86	68	7	6+10	10	1	pce

Uponor Q&E tee PPSU

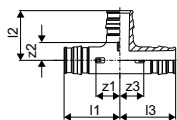

Item no.	Dimension	l1 mm	l2 mm	l3 mm	z1 mm	z2 mm	z3 mm	p bar	Qty 2	Qty 1	UOM
1008686	25-25-25	47	42	47	20	15	20	6+10	25	5	pce
1001250	32-32-32	59	53	59	24	18	24	6+10	10	1	pce
1008688	40-40-40	74	65	74	30	22	30	6+10	5	1	pce
1042861	50-50-50	92	83	92	38	29	38	6+10	3	1	pce
1042860	63-63-63	112	102	112	44	5	44	6+10	2	1	pce
1085081	75-75-75	156	123	156	70	37	70	6+10	2	1	pce

Uponor Q&E

Uponor Q&E tee reducer PPSU

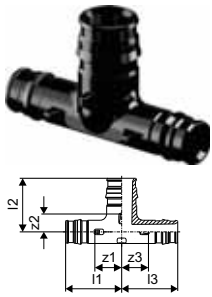

Item no.	Dimension	l1 mm	l2 mm	l3 mm	z1 mm	z2 mm	z3 mm	p bar	Qty 2	Qty 1	UOM
1008712	25-32-25	52	50	52	24	15	24	6+10	15	1	pce
1001426	32-25-25	55	45	47	20	18	20	6+10	15	1	pce
1001428	32-25-32	55	45	55	20	18	20	6+10	15	1	pce
1008713	32-40-32	65	61	65	30	18	30	6+10	10	1	pce
1008708	40-25-32	63	49	55	20	22	20	6+10	5	1	pce
1008695	40-25-40	63	49	63	20	22	20	6+10	5	1	pce
1008709	40-32-32	68	57	59	24	22	24	6+10	5	1	pce
1008696	40-32-40	68	57	68	24	22	24	6+10	5	1	pce
1042876	50-25-40	92	57	82	38	29	39	6+10	4	1	pce
1042864	50-25-50	92	57	92	38	29	38	6+10	4	1	pce
1042863	50-32-50	92	64	92	38	29	38	6+10	4	1	pce
1042862	50-40-40	92	73	82	38	29	39	6+10	4	1	pce
1042875	50-40-50	92	73	92	38	29	38	6+10	4	1	pce
1042871	63-25-50	112	62	99	44	35	45	6+10	2	1	pce
1042873	63-25-63	112	60	112	44	33	44	6+10	2	1	pce
1042870	63-32-63	112	70	112	44	35	44	6+10	2	1	pce
1042869	63-40-40	112	78	99	44	35	55	6+10	2	1	pce
1042872	63-40-63	112	78	112	44	35	44	6+10	2	1	pce
1042868	63-50-50	112	89	99	44	35	45	6+10	2	1	pce
1042874	63-50-63	112	89	112	44	35	44	6+10	2	1	pce
1085083	75-25-75	118	67	118	32	39	32	6+10	4	1	pce
1085082	75-40-75	118	83	118	32	83	32	6+10	4	1	pce

Uponor Q&E adapter male thread PL

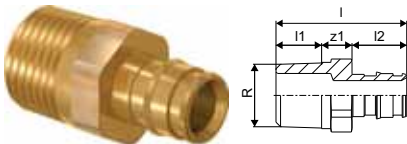

Item no.	Dimension	l mm	l1 mm	l2 mm	R inch	z1 mm	p bar	Qty 2	Qty 1	UOM
1023007	25-R3/4"MT	55	17	27	1/2	11	6+10	70	5	pce
1047191	32-R1"MT	65	21	34	3/4	10	6+10	10	1	pce

Uponor Q&E adapter male thread PL/DR

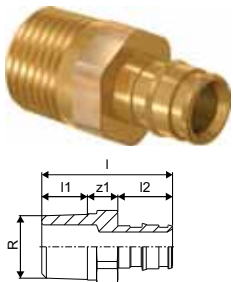

Item no.	Dimension	l mm	l1 mm	l2 mm	R inch	z1 mm	p bar	Qty 2	Qty 1	UOM
1085077	40-R1 1/4"MT	73	19	42	1 1/4	12	6+10	16	1	pce
1085076	50-R1 1/2"MT	89	20	52	1 1/2	17	6+10	8	1	pce
1085075	63-R2"MT	100	24	65	2	11	6+10	6	1	pce
1085074	75-R2 1/2"MT	126	27	86	2 1/2	13	6+10	6	1	pce

Uponor Q&E

Uponor Q&E adapter male thread PL

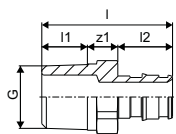

Item no.	Dimension	l	l1	l2	G	z1	p	Qty 2	Qty 1	UOM
		mm	mm	mm	inch	mm	bar			
1047862	25-G3/4"MT	48	11	27	3/4	10	6+10	40	5	pce
1047863	25-G1"MT	49	11	27	1	11	6+10	40	5	pce
1047864	50-G1 1/2"MT	82	17	52	1 1/2	13	6+10	8	1	pce

Uponor Q&E adapter male thread PL W

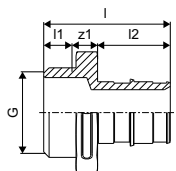

Item no.	Dimension	l	l1	l2	G	z1	p	Qty 2	Qty 1	UOM
		mm	mm	mm	inch	mm	bar			
1008730	32-G1"MT	56	10	34	1	12	6+10	20	1	pce
1022290	40-G1"MT	64	11	42	1	11	6+10	16	1	pce
1008732	40-G1 1/4"MT	68	14	42	1 1/4	12	6+10	8	1	pce
1008866	50-G1 1/4"MT	78	14	52	1 1/4	12	6+10	8	1	pce
1008867	63-G2"MT	95	17	65	2	13	6+10	6	1	pce

Uponor Q&E adapter male thread DR W

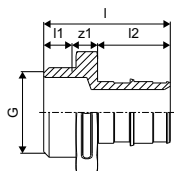

Item no.	Dimension	l	l1	l2	G	z1	p	Qty 2	Qty 1	UOM
		mm	mm	mm	inch	mm	bar			
1063810	25-G1"MT	47	11	27	1	9	6+10	35	5	pce
1063724	32-G1"MT	56	10	34	1	12	6+10	10	1	pce
1063725	40-G1 1/4"MT	68	14	42	1 1/4	12	6+10	16	1	pce
1063727	50-G1 1/4"MT	78	14	52	1 1/4	12	6+10	8	1	pce
1063728	63-G2"MT	95	17	65	2	13	6+10	6	1	pce

Uponor Q&E elbow adapter female thread PL

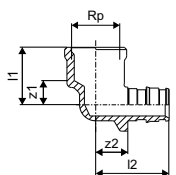

Item no.	Dimension	l1	l2	G	z1	z2	p	Qty 2	Qty 1	UOM
		mm	mm	inch	mm	mm	bar			
1023026	25-G3/4"FT	26	44	3/4	10	17	6+10	35	5	pce

Uponor Q&E

Uponor Q&E adapter female thread PL

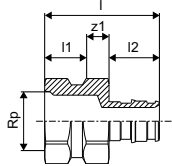

Item no.	Dimension	l	l1	l2	Rp	z1	p	Qty 2	Qty 1	UOM
		mm	mm	mm	inch	mm	bar			
1023012	25-Rp3/4"FT	51	18	27	3/4	6	6+10	40	5	pce
1023013	25-Rp1"FT	55	22	27	1	6	6+10	35	5	pce

Uponor Q&E adapter female thread PL

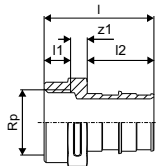

Item no.	Dimension	l	l1	l2	G	z1	p	Qty 2	Qty 1	UOM
		mm	mm	mm	inch	mm	bar			
1047866	32-G1"FT	56	13	34	1	9	6+10	20	1	pce
1047867	40-G1 1/4"FT	68	16	42	1 1/4	10	6+10	20	1	pce

Uponor Q&E adapter female thread PL/DR

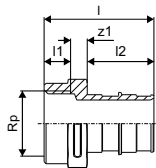

Item no.	Dimension	l	l1	l2	Rp	z1	p	Qty 2	Qty 1	UOM
		mm	mm	mm	inch	mm	bar			
1085078	50-RP1 1/2"FT	92	21	52	1 1/2	19	6+10	8	1	pce

Uponor Ecoflex

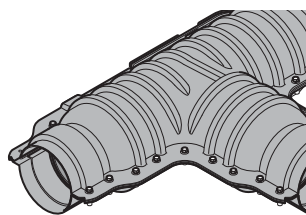

The Uponor Ecoflex system includes all accessories for complete heating, cooling networks as well as for potable water and warm tap water supply.

The accessories are designed to complement the

Uponor Ecoflex pipes and fittings.

Your benefits

- Practical and easy to install components
- Robust, reliable and safe
- Full range of components for all installation needs



Specification

- All accessories are corrosion resistant.

Application

- Ecoflex accessories are designed to complete the assortment in buried installation.

Certification

- Approvals should be checked by local responsible person

Uponor Ecoflex rubber end cap Single

- For one medium pipe
- Protect the pipe end against moisture and dirt
- Watertight up to 0,3 bar
- Contain EPDM rubber cap, stainless steel and sealing ring

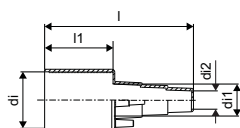

Item no.	Dimension	l mm	l1 mm	di mm	di1 mm	di2 mm	Weight kg	Qty 1	UOM
1018316	25+32+40/68	174	80	68	40	25	0,15	1	pce
1018246	25+32+40/90	174	80	90	40	25	0,19	1	pce
1018315	25+28+32/140+145	184	90	140	32	25	0,33	1	pce
1036248	32+40+50/90	174	80	90	50	32	0,19	1	pce
1018313	32+40+50/175	184	90	175	50	32	0,42	1	pce
1018314	40+50+63/140+145	184	90	140	63	40	0,34	1	pce
1086685	50+63/200	154	90	200	63	50	0,48	1	pce
1018312	63+75/175	184	90	175	75	63	0,44	1	pce
1018310	75+90+110/200	184	90	200	110	75	0,51	1	pce
1018311	90+110/175	184	90	175	110	90	0,46	1	pce
1067757	125/200	142	90	200	125	109	0,55	1	pce
1083869	90+110+125/250	200	90	250	125	90	0,67	1	pce

Uponor Ecoflex

Uponor Ecoflex rubber end cap Twin

- For two medium pipes
- Protect the pipe end against moisture and dirt
- Watertight up to 0,3 bar
- Contain EPDM rubber cap, stainless steel and sealing ring

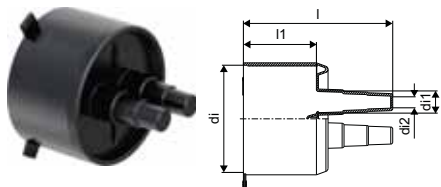

Item no.	Dimension	l mm	l1 mm	di mm	di1 mm	di2 mm	Weight kg	Qty 1	UOM
1018245	25+32+40/140+145	184	90	140	40	25	0,36	1	pce
1018309	25+32+40/175	184	90	175	40	25	0,44	1	pce
1018308	25+32+50/175	184	90	175	50	25	0,45	1	pce
1018307	40+50+63/200	184	90	200	63	40	0,52	1	pce
1088979	75+90/250	194	90	250	90	75	0,80	1	pce

Uponor Ecoflex rubber end cap Quattro

- For four medium pipes
- Protect the pipe end against moisture and dirt
- Watertight up to 0,3 bar
- Contain EPDM rubber cap, stainless steel and sealing ring

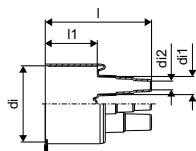

Item no.	Dimension	l mm	l1 mm	di mm	di1 mm	di2 mm	Weight kg	Qty 1	UOM
1086838	20+25+32/140	184	90	140	32	20	0,45	1	pce
1018306	18-32+25-32/175	184	90	175	32	18	0,49	1	pce

Uponor Ecoflex tee insulation set

- Tee-set for connecting the casing pipe
- ABS half sheels with insulation and reducer
- Traffic load of 60 tons

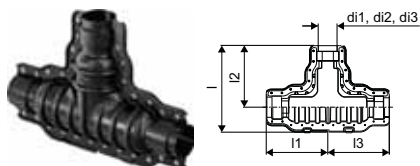

Item no.	Dimension	l mm	l1 mm	l2 mm	l3 mm	di1 mm	di2 mm	di3 mm	Weight kg	Qty 2	Qty 1	UOM
1060986	140/90/68	666	470	470	470	140	90	68	9,77	5	1	pce
1060982	200/175/145/140	786	562	562	562	200	175	140	13,53	4	1	pce

Uponor Ecoflex

Uponor Ecoflex elbow insulation set

- Elbow set for connecting the casing pipe
- ABS half shells with insulation and reducer
- Traffic load of 60 tons

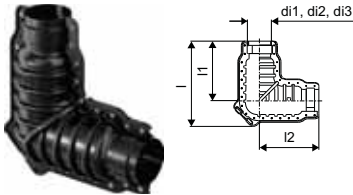

Item no.	Dimension	l	l1	l2	di1	di2	di3	Weight	Qty 2	Qty 1	UOM
		mm	mm	mm	mm	mm	mm	kg			
1060985	200/175/145/140	806	563	563	200	175	140	10,55	3	1	pce

Uponor Ecoflex coupling insulation set

- Straight set for connecting the casing pipe
- ABS half shells with insulation and reducer
- Traffic load of 60 tons

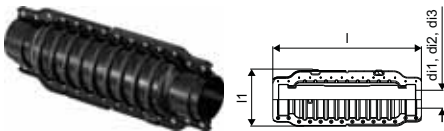

Item no.	Dimension	l	l1	di1	di2	di3	Weight	Qty 2	Qty 1	UOM
		mm	mm	mm	mm	mm	kg			
1060984	200/175/145/140	1125	426	200	175	140	9,66	6	1	pce

Uponor Ecoflex tee connection shell

- Tee-set for connecting the casing pipe
- ABS half shells without foam shells and reducers
- Traffic load of 60 tons

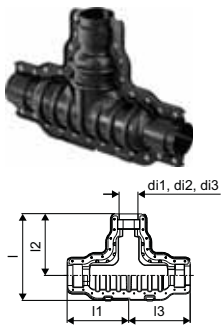

Item no.	Dimension	l	l1	l2	l3	di1	di2	di3	Weight	Qty 2	Qty 1	UOM
		mm	mm	mm	mm	mm	mm	mm	kg			
1090041	200/175/145/140	786	562	562	562	200	175	140	10,90	4	1	pce

Uponor Ecoflex

Uponor Ecoflex tee foam shell

- PUR foam half-shells used in tee insulation set
- One piece include two half shells

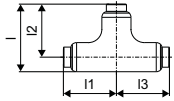

Item no.	Dimension	l mm	l1 mm	l2 mm	l3 mm	Weight kg	Qty 1	UOM
1090042	200/175/145/140	450	353	353	353	1,08	1	pce

Uponor Ecoflex reducer ring

- Balance different casing pipe dimensions in an insulation set

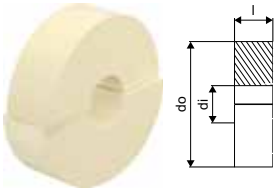

Item no.	Dimension	l mm	di mm	do mm	Weight kg	Qty 2	Qty 1	UOM
1060991	200/68	70	68	229	0,09	8	1	pce
1060990	200/90	70	90	229	0,08	8	1	pce
1060989	200/140	70	140	229	0,07	12	1	pce
1060988	200/175	70	175	229	0,04	12	1	pce
1060987	200	70	200	229	0,03	12	1	pce

Uponor Ecoflex jacket joint set

- Straight set for connecting of casing pipe
- Pipe piece with two shrink sleeves
- Traffic load 60 tons

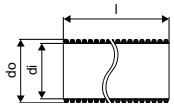

Item no.	Dimension	l mm	di mm	do mm	Weight kg	Qty 1	UOM
1090230	68+90	550	95	110	1,30	1	pce
1090231	140+145	550	175	200	1,50	1	pce
1084574	175+200	650	218	250	2,80	10	pce
1083872	250	720	275	315	4,70	9	pce

Uponor Ecoflex H-insulation set

- H-set for connecting the casing pipe from single to twin lines
- ABS half shells with insulation and reducer spigots
- Additional rubber end caps needed for tightness
- Traffic load with special concret construction possible

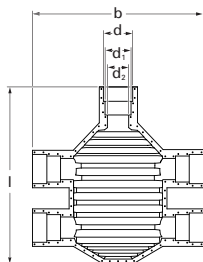

Item no.	Dimension	d mm	d1 mm	d2 mm	l mm	b mm	Weight kg	Qty 1	UOM
1007355	200/175/145/140	200	175	140/145	1290	1260	19,00	1	pce

Uponor Ecoflex

Uponor Ecoflex shrink sleeve

- Seal casing pipe with chamber or other casing outlets

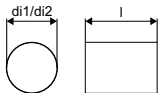

Item no.	Dimension	l mm	di1 mm	di2 mm	Weight kg	Qty 1	UOM
1018379	140/145	300	220	135	0,30	1	pce
1018380	175/200	300	270	160	0,55	1	pce
1084575	250	300	335	222	0,72	15	1 pce

Uponor Ecoflex house connection elbow Single

- Pre-insulated PE-Xa pipe elbow
- One medium pipe PE-Xa
- Max. load 6 bar / 95°C
- PUR foam, PE casing

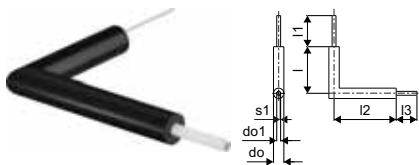

Item no.	Dimension	l mm	l1 mm	l2 mm	l3 mm	do mm	do1 mm	s1 mm	Weight kg	Qty 1	UOM
12.21 1085108	75X6,8/205	900	600	1200	400	200	75	6,8	15,20	1	pce

Uponor Ecoflex house connection elbow Twin

- Pre-insulated PE-Xa pipe elbow
- Two medium pipes PE-Xa
- Max. load 6 bar / 95°C
- PUR foam, PE casing

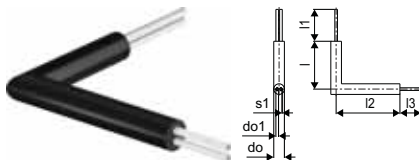

Item no.	Dimension	l mm	l1 mm	l2 mm	l3 mm	do mm	do1 mm	s1 mm	Weight kg	Qty 1	UOM
12.21 1085104	2X50X4,6/205	900	600	1200	400	200	50	4,6	14,10	1	pce
12.21 1085105	2X63X5,8/205	900	600	1200	400	200	63	5,8	17,30	1	pce
12.21 1088822	2x75x6,8/250	900	560	1200	375	250	75	6,8	22,40	1	pce

Uponor Ecoflex

Uponor Ecoflex wall seal PWP

- For concrete core hole or fibre cement pipe
- Part to seal the casing pipe
- Applicable for PWP (pressurized water)
- Watertight up to 0,3bar

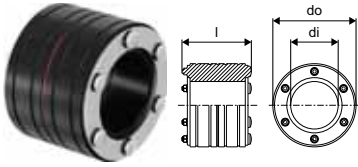

Item no.	Dimension	l mm	di mm	do mm	Weight kg	Qty 1	UOM
1007360	140/145	110	145	200	2,42	1	pce
1007361	175	110	175	250	3,70	1	pce
1007362	200	110	200	300	4,90	1	pce

di = jacket pipe diameter
do = core hole drilling

Uponor Ecoflex additional insert

- For concrete core hole or fibre cement pipe
- Part to eliminate radial stress of the casing pipe
- Use with Uponor wall seal PWP only
- di = jacket pipe diameter
- do = core hole drilling



Item no.	Dimension	l mm	di mm	do mm	Weight kg	Qty 1	UOM
1007365	140/145	65	140	200	1,43	1	pce
1007366	175	65	175	250	2,30	1	pce
1007367*	200	65	200	300	3,30	1	pce

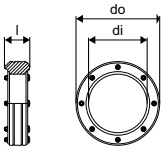

Uponor Ecoflex fibre cement pipe PWP

- Enbed in a brick wall or concrete wall
- Alternative to water-proof concrete core hole
- Applicable for Uponor wall seal PWP (pressurized water)
- „Dimension“ = used for jacket pipe diameter



Item no.	Dimension	l mm	di mm	do mm	Weight kg	Qty 1	UOM
1007370	140/145	400	200	250	15,20	1	pce
1007371	175	400	250	300	18,80	1	pce
1007372	200	400	300	350	22,00	1	pce

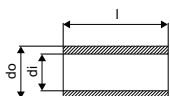

Uponor Ecoflex

Uponor Ecoflex epoxy resin set PWP

- Pre-treatment of the concrete core hole surface
- Applicable for Uponor wall seal PWP (pressurized water)



Item no.	Dimension	Weight kg	Qty 1	UOM
1007373	1,1 kg/3,5m2	1,45	1	set

Uponor Ecoflex wall sleeve set NPW

- For concrete-cast and brick walls
- Applicable for NPW = no pressurized water area
- Contain PE pipe and shrink sleeve

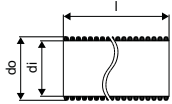

Item no.	Dimension	l mm	di mm	do mm	Weight kg	Qty 1	UOM
1018267	68+90	550	95	110	1,00	1	pce
1018269	140+145	550	175	200	1,30	1	pce
1018268	175+200	550	218	250	1,90	1	pce
1083871	250	550	275	315	2,90	16	1 pce

Uponor Ecoflex wall through sealing

- For concrete-cast and brick walls
- Prevents moisture from entering the building
- Applicable for NPW = no pressurized water area

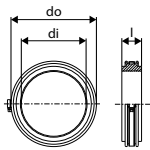

Item no.	Dimension	l mm	di mm	do mm	Weight kg	Qty 2	Qty 1	UOM
1034202	140+145	40	140	190	0,35	40	1	pce
1034203	175	40	175	225	0,44	30	1	pce
1034204	200	50	200	250	0,62	20	1	pce
1090415	250	50	250	300	0,79	1	1	pce

Uponor Ecoflex repair sleeve

- Shrink sleeve to seal damages in casing pipe

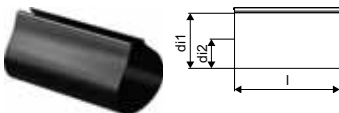

Item no.	Dimension	l mm	di1 mm	di2 mm	s mm	Weight kg	Qty 1	UOM
1036014	140+145+175+200-700mm	700	226	98	1,7	1,20	1	pce

Uponor Ecoflex

Uponor Ecoflex shrink tape

- Shrinkable tape use for sealing damaged casing pipes

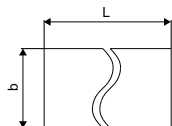

Item no.	Dimension	L m	b1 mm	Weight kg	Qty 2	Qty 1	UOM
1093120	160mm x 10m	10	160	2,40	30	1	pce

Uponor Ecoflex trench warning tape, red

- For marking the position of buried Ecoflex pipes
- Tape marking with required application symbols

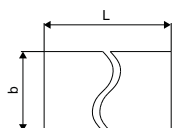

Item no.	Dimension	L m	b mm	Weight kg	Qty 1	UOM
1018385	40mm x 250m	250	40	2,00	1	pce

Uponor Ecoflex uncoiler type1

- Support to decoiling the pipe
- Max. load capacity of 650 kg



Item no.	l mm	h mm	Weight kg	Qty 1	UOM
1036645	2400	1050	100,00	1	pce

Uponor Multi pipe cutting tool

- outside diameters 25-63 mm



Item no.	Dimension	Qty 2	Qty 1	UOM
1089675	25-63	12	1	pce
1089777	25-63 blade (wheel)	50	1	pce

Uponor Multi pipe cutting tool

- outside diameters 50-125 mm



Item no.	Dimension	Qty 2	Qty 1	UOM
1089676	50-125	8	1	pce
1089778	50-125 blade (wheel)	50	1	pce

Uponor Ecoflex

Uponor MLC deburring tool universal



Item no.	Qty 2	Qty 1	UOM
1060167	50	1	pce

Uponor Wipex sleeve plier

- Expansion tool for the WIPEX coupling sleeve



Item no.	Dimension	l mm	Weight kg	Qty 2	Qty 1	UOM
1046407	1 - 1 1/2	145	0,15	25	1	pce
1046408	1 1/2 - 3 1/2	200	0,23	25	1	pce

Uponor Q&E graphite paste, manual tools



Item no.	Dimension	Weight kg	Qty 1	UOM
1008334	30g	0,03	20	pce

Uponor Q&E graphite paste



Item no.	Dimension	Weight kg	Qty 1	UOM
1005017	100g	0,10	1	pce

Uponor Wipex O-ring PN 10

- Sealing ring for WIPEX Coupling Inner sleeve 10bar ISO A S3.2



Item no.	Dimension	d mm	Weight kg	Qty 1	UOM
1026535	14,0x1,78/25x3,5 PN10	25	0,00	1	pce
1018605	19,0x2,0/32x4,4 PN10	32	0,00	1	pce
1018606	23,5x2,5/40x5,5 PN10	40	0,00	1	pce
1018607	30,0x2,5/50x6,9 PN10	50	0,00	1	pce
1018608	39,3x2,6/63x8,6 PN10	63	0,00	1	pce
1026578	48,0x3/75x10,3 PN10	75	0,00	1	pce
1026582	58,0x3/90x12,3 PN10	90	0,00	1	pce
1026583	72,0x3/110x15,1 PN10	110	0,00	1	pce

Uponor Wipex O-ring PN6

- Sealing ring for WIPEX coupling inner sleeve 6bar ISO A S5



Item no.	Dimension	d mm	Weight kg	Qty 1	UOM
1026549	17,17x1,78/25x2,3 PN6	25	0,00	1	pce
1018598	22x2,0/32x2,9 PN6	32	0,00	1	pce
1018599	27,0x2,5/40x3,7 PN6	40	0,00	100	1
1018600	34,3x2,5/50x4,6 PN6	50	0,00	1	pce
1018601	45,7x2,62/63x5,8 PN6	63	0,00	1	pce
1018602	54,2x3,0/75x6,8 PN6	75	0,00	1	pce
1018603	65,0x3,0/90x8,2 PN6	90	0,00	1	pce
1018604	80,0x3,0/110x10 PN6	110	0,00	1	pce

Uponor Ecoflex

Uponor Wipex O-ring

- Sealing ring for Wipex base fittings



Item no.	Dimension	d mm	d1 mm	s mm	DN inch	Weight kg	Qty 2	Qty 1	UOM
1018595	43,5x3,0/G1 1/4	43,5	32	3,0	1 1/4	0,00	100	1	pce
1018596	61,9x3,53/G2	61,9	50	3,53	2	0,00		1	pce
1013306	90,0X4,0/G3	90,0	80	4,0	3	0,00		1	pce
1009105	115,3X4,2/G4	115,3	100	4,2	4	0,00		1	pce

Uponor Ecoflex sealing paste

- Material to seal the insulation set.



Item no.	Dimension	Weight kg	Qty 1	UOM
1060996	750ml	0,40	1	pce

Uponor Ecoflex plastic spread rivet



Item no.	Weight kg	Qty 1	UOM
1021997	0,00	1	pce

Uponor Ecoflex screw set

- Screw set for H insulation set

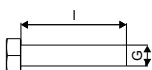

Item no.	l mm	do mm	Weight kg	Qty 1	UOM
1021999	41	8	0,03	1	pce

Uponor Ecoflex screw set

- Screw set for tee, elbow, straight insulation set

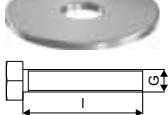

Item no.	Dimension	l mm	M mm	Weight kg	Qty 1	UOM
1060995	M6x30 (34pcs)	30	6	0,43	1	pce

Uponor Ecoflex end cap clamping ring

- Clamp ring for rubber end cap



Item no.	Dimension	d mm	d2 mm	Weight kg	Qty 1	UOM
1018319	68	60-80	68	0,02	1	pce
1018320	90	80-100	90	0,03	1	pce
1018318	175	170-190	175	0,07	1	pce
1018321	200	190-210	200	0,08	1	pce

Uponor Ecoflex

Uponor Ecoflex end cap sealing ring

- Sealing ring used for the rubber end cap.



Item no.	Dimension	Weight kg	Qty 1	UOM
1018659	68	0,02	1	pce
1018660	90	0,02	1	pce

Uponor Ecoflex swelling ring 2k

- Sealing ring used for the rubber end cap.



Item no.	Dimension	d2 mm	Weight kg	Qty 1	UOM
1072157	140/145	140/145	0,06	1	pce
1072158	175	175	0,07	1	pce
1072159	200	200	0,08	1	pce

Uponor Uncoiling

Uponor MLC pipe straightening tool

- The pipe straightener is not compatible with the Uponor uncoiler
- Fixing has to be managed on site.



Item no.	Dimension	l mm	b mm	h mm	Qty 2	Qty 1	UOM
1010512	14-25	230	195	77	60	1	pce

Uponor Magna uncoiler with pipe guide



Item no.	Qty 2	Qty 1	UOM
1035807	4	1	pce

Uponor Ecoflex uncoiler type1

- Support to decoiling the pipe
- Max. load capacity of 650 kg



Item no.	l mm	h mm	Weight kg	Qty 1	UOM
1036645	2400	1050	100,00	1	pce

Uponor Wipex sleeve plier

- Expansion tool for the WIPEX coupling sleeve



Item no.	Dimension	l mm	Weight kg	Qty 2	Qty 1	UOM
1046407	1 - 1 1/2	145	0,15	25	1	pce
1046408	1 1/2 - 3 1/2	200	0,23	25	1	pce

Uponor Cutting & Preparation

Uponor Multi pipe & conduit cutting tool

- Easy cutting with a special triangle blade
- outside diameters 12-25 mm



Item no.	Dimension		Qty 2	Qty 1	UOM
1089674	12-25		36	1	pce
1089776	12-25	blade	150	1	pce

Uponor Multi pipe cutting tool

- outside diameters 32-40 mm



Item no.	Dimension		Qty 2	Qty 1	UOM
1089677	32-40		12	1	pce
1089779	32-40	blade	50	1	pce

Uponor Multi pipe cutting tool

- outside diameters 25-63 mm



Item no.	Dimension		Qty 2	Qty 1	UOM
1089675	25-63		12	1	pce
1089777	25-63	blade (wheel)	50	1	pce

Uponor Multi pipe cutting tool

- outside diameters 50-125 mm



Item no.	Dimension		Qty 2	Qty 1	UOM
1089676	50-125		8	1	pce
1089778	50-125	blade (wheel)	50	1	pce

Uponor MLC pipe cutting tool blade



Item no.		Qty 2	Qty 1	UOM
1013721	blade	10	1	pce

Uponor Flex pipe cutting tool PEX

- Pipe cutting tool for Uponor flexible pipes, outside diameters 12-25 mm.
- Blades not compatible with Uponor pipe cutter 1001369



Item no.	Dimension		Qty 2	Qty 1	UOM
1089673	12-25		36	1	pce

Uponor MLC pipe cutting tool blade



Item no.	Dimension		Qty 2	Qty 1	UOM
1006635	25-63	blade (wheel)	1000	1	pce
1014173	50-110	blade (wheel)	20	1	pce

Uponor Cutting & Preparation

Uponor MLC pipe cutting + deburring tool



Item no.	Dimension	Qty 2	Qty 1	UOM
1014334	63-110	32	1	pce
1014320	63-110 blade (wheel)	100	1	pce

Uponor MLC bevelling tool

- For bevelling the Uponor Uni Pipe PLUS and MLC pipes.
- Supplied with manual toggle. Without manual toggle to be used as attachment for self-driving screw with tapping screw thread.



Item no.	Dimension	Qty 2	Qty 1	UOM
1006830	16	50	1	pce
1015749	20	1200	1	pce
1015756	25	960	1	pce
1015762	32	900	1	pce

Uponor MLC bevelling tool



Item no.	Dimension	Qty 2	Qty 1	UOM
1006638	40	600	1	pce
1015808	50	600	1	pce
1014339	63	600	1	pce
1014344	75	600	1	pce

Uponor MLC bevelling tool

- For bevelling the Uponor Uni Pipe PLUS and MLC pipes.



Item no.	Dimension	Qty 2	Qty 1	UOM
1015739	16/20/25	60	1	pce

Uponor MLC deburring tool universal



Item no.	Qty 2	Qty 1	UOM
1060167	50	1	pce

Uponor Cutting & Preparation

Uponor MLC bending spring inside

- bending spring for Uponor Uni Pipe PLUS and MLC pipes.



Item no.	Dimension	Qty 2	Qty 1	UOM
1013729	16	100	1	pce
1013734	20	75	1	pce
1013737	25	50	1	pce
1013739	32	40	1	pce

Uponor MLC bending spring outside

- bending spring for Uponor Uni Pipe PLUS and MLC pipes.



Item no.	Dimension	Qty 2	Qty 1	UOM
1006639*	14	550	1	pce
1006640	16	55	1	pce
1013792	20	45	1	pce
1013794	25	45	1	pce

Uponor Uni Pipe PLUS bending tool

- producing evenly formed bends in Uponor Uni Pipe PLUS pipes with outer diameters up to 32 mm.
- Delivered complete in tool case with bending segments.



Item no.	Dimension	Qty 2	Qty 1	UOM
1071925	16-32	100	1	pce

Uponor MLC bending tool

- producing evenly formed bends in Uponor MLC Pipe with outer diameters up to 32 mm.
- Delivered complete in tool case with bending segments.



Item no.	Dimension	Qty 2	Qty 1	UOM
1013773	16-32	48	1	pce

Uponor Pressing

Uponor S-Press manual tool w/o inserts

- in conjunction with exchangeable inserts
- Supplied in case without exchangeable inserts



Item no.	Dimension	d mm	Qty 2	Qty 1	UOM
1015764	14-20	14-20	100	1	pce

Uponor S-Press manual tool insert

- For inserting into the manual pressing tool



Item no.	Dimension	d mm	Qty 2	Qty 1	UOM
1015776*	14	14	400	1	pce
1015777	16	16	50	1	pce
1015780	20	20	50	1	pce

Uponor S-Press tool UP110 without jaws

- supplied in carrying case, complete with battery and charger unit
- without pressing jaws.
- Range of application up to 110 mm.

Technical specifications:

- Quick pressing due to short pressing cycle
- Crimping force: linear thrust of approx. 32 kN
- Battery capacity: High-power Makita 3.0 Ah Li-Ion battery
- Charging time: 22 min
- Weight incl. battery: without jaw 3.5 kg
- Dimensions tool: 366 x 81 x 317 mm
- Revolving/rotatable: approx. 350° rotating pressing jaw holder



Item no.	Qty 2	Qty 1	UOM
1083612	20	1	set

Uponor S-Press battery UP110

- Akku 18 V / 3,0 Ah, Li-Ion (54 Wh)
- Battery voltage: 18 V
- Battery capacity: 3.0 Ah
- Charging time: With SPI S-PRESS BATTERY CHARGER: 22 min
- Cell technology: Li-Ion
- Weight: 0,6 kg



Item no.	OV V	Qty 2	Qty 1	UOM
1083608*	18	10	1	pce

Uponor Pressing

Uponor S-Press battery charger

- Quick-charger for 18V Li-Ion batteries, 230 V
- Charging time: 1.3 Ah 15 min, 3.0 Ah 22 min
- Mains supply: 230 V AC
- Voltage range: 18 V
- Weight: 1,0 kg



Item no.	Dimension	OV V	Qty 2	Qty 1	UOM
1083610*	Mini2, UP110	230	72	1	pce

Uponor S-Press electric tool w/o jaws UP75

Technical specifications:

- Weight: 3.30 kg
- Nominal voltage: 230 V AC / 50 Hz
- Nominal capacity: 200 Watt
- Press power: ca. 32 kN
- Press duration: ca. 7 sec.



Item no.	d mm	OV V	Qty 2	Qty 1	UOM
1007082	- 110	230	20	1	pce

Uponor S-Press spare battery UP75

- for the battery powered pressing machine UP 75
- Not compatible to the Ni-Cd charger unit.



Item no.	OV V	Qty 2	Qty 1	UOM
1006949*	12	12	1	pce

Uponor S-Press spare charger Mini UP75

- or the re-chargeable battery of the pressing machine UP 75 and Mini KSP0



Item no.	OV V	Qty 2	Qty 1	UOM
1006950	230	10	1	pce

Uponor S-Press jaw UPP1

- pressing jaws for Uponor MLC press fittings



Item no.	Dimension	d mm	Qty 2	Qty 1	UOM
1007084	16	16	216	1	pce
1007086	20	20		1	pce
1007087	25	25		1	pce
1007088	32	32		1	pce

Uponor Pressing

Uponor S-Press jaw UPP1

- pressing jaws for Uponor MLC press fittings



Item no.	Dimension	d mm	Qty 2	Qty 1	UOM
1015768	40	40	108	1	pce
1015792	50	50	108	1	pce

Uponor S-Press base unit for chain

- Base unit for the pressing chain to press Uponor MLC press fittings 63 - 110 in conjunction with the pressing tool UP 110, UP 75 and UP 75 EL



Item no.	Dimension	d mm	Qty 1	UOM
1046545	63-110	63-110	1	pce

Uponor S-Press chain

- pressing chain to be used together with the Base unit to press Uponor MLC press fittings 63 - 110 in conjunction with the pressing tool UP 110, UP 75 and UP 75 EL



Item no.	Dimension	d mm	Qty 2	Qty 1	UOM
1046541	63	63	72	1	pce
1046542	75	75	72	1	pce
1046543*	90	90	72	1	pce
1046544*	110	110	54	1	pce

Uponor S-Press tool Mini2 with KSP0 jaw

- Uponor S-Press tool Mini² supplied in carrying case, complete with battery and charger unit and pressing jaws.
- Range of application up to 32 mm.

Technical specifications:

- Very quick pressing thanks to short pressing cycle of 3-4 seconds
- Crimping force: linear thrust of approx. 15 kN
- Battery capacity: High-power Makita 1.3 Ah Li-Ion battery (3.0 Ah optional)
- Charging time: 1.5 Ah 15 min. 3.0 Ah 22 min
- Weight incl. battery: without jaws 1.7 kg
- Dimensions tool: 377 x 75 x 116 mm
- Revolving/rotatable: approx. 350° rotating pressing jaw holder



Item no.	Dimension	Qty 2	Qty 1	UOM
1083586	16/20/25/32	30	1	set

Uponor Pressing

Uponor S-Press tool Mini2 with KSP0 jaw

- Uponor S-Press tool Mini² supplied in carrying case, complete with battery and charger unit and pressing jaws.
- Range of application up to 25 mm.

Technical specifications:

- Very quick pressing thanks to short pressing cycle of 3-4 seconds
- Crimping force: linear thrust of approx. 15 kN
- Battery capacity: High-power Makita 1.3 Ah Li-Ion battery (3.0 Ah optional)
- Charging time: 1.5 Ah 15 min. 3.0 Ah 22 min
- Weight incl. battery: without jaws 1.7 kg
- Dimensions tool: 377 x 75 x 116 mm
- Revolving/rotatable: approx. 350° rotating pressing jaw holder



Item no.	Dimension	Qty 2	Qty 1	UOM
1083594	16/20/25	25	1	set

Uponor S-Press tool Mini2 without jaws

- Uponor S-Press tool Mini² supplied in carrying case, complete with battery and charger unit.
- Range of application up to 32 mm.

Technical specifications:

- Very quick pressing thanks to short pressing cycle of 3-4 seconds
- Crimping force: linear thrust of approx. 15 kN
- Battery capacity: High-power Makita 1.5 Ah Li-Ion battery (3.0 Ah optional)
- Charging time: 1.5 Ah 15 min. 3.0 Ah 22 min
- Weight incl. battery: without jaws 1.7 kg
- Dimensions tool: 377 x 75 x 116 mm
- Revolving/rotatable: approx. 350° rotating pressing jaw holder



Item no.	Qty 1	UOM
1085388	1	pce

Uponor S-Press tool Mini2

- Uponor SPI S-Press tool Mini² without carrying case, without battery and charger unit and without pressing jaws.



Item no.	Qty 1	UOM
1087260	1	pce

Uponor Pressing

Uponor S-Press battery Mini2

- Battery 18 V / 1.5 Ah, Li-Ion (27 Wh)
- Battery voltage: 18 V
- Battery capacity: 1.5 Ah
- Charging time: With SPI S-Press Battery Charger: 15 min
- Cell technology: Li-Ion
- Weight: 0,4 kg



Item no.	OV V	Qty 2	Qty 1	UOM
1083605	18	48	1	pce

Uponor S-Press battery charger

- Quick-charger for 18V Li-Ion batteries, 230 V
- Charging time: 1.3 Ah 15 min,
3.0 Ah 22 min
- Mains supply: 230 V AC
- Voltage range: 18 V
- Weight: 1,0 kg



Item no.	Dimension	OV V	Qty 2	Qty 1	UOM
1083610*	Mini2, UP110	230	72	1	pce

Uponor S-Press battery Mini

- Battery: 9.6V for Uponor battery pressing tool Mini KSP0.



Item no.	OV V	Qty 2	Qty 1	UOM
1015703	9,6	120	1	pce

Uponor S-Press jaw Mini KSP0

- Uponor pressing jaws MLC Mini KSP0



Item no.	Dimension	d mm	Qty 2	Qty 1	UOM
1007091*	16	16	5	1	pce
1007093*	20	20	5	1	pce
1007094*	25	25	5	1	pce
1007095*	32	32	5	1	pce

Uponor Expanding

Uponor Q&E manual expansion tool, heads S3,2 S5,0



Item no.	Dimension	p bar	Qty 1	UOM
1004064	16/20/25	6+10	1	set

Uponor Q&E expansion tool plier



Item no.	Qty 1	UOM
1004002	1	pce

Uponor Q&E expansion tool with heads M12



Item no.	Dimension	p bar	stroke mm	Qty 1	UOM
1063112	6BAR 9,9/20	6	14	1	set
1057166	16/20/25 6bar	6	14	1	set
1057167	16/20/25 10bar	10	14	1	set

Uponor Q&E head M12



Item no.	Dimension	stroke mm	Qty 1	UOM
1060702	9,9x1,1	14	1	pce

Uponor Q&E expansion head M12/M18



Item no.	Dimension	d mm	s mm	p bar	stroke mm	Qty 1	UOM
1057184*	14/15x2,5	14/15	2,0/2,5	6+10	14/25	1	pce
1057172	16x1,8/2,0/2,2	16	1,8/2,0/2,2	6+10	14/25	1	pce
1057185	17/18x2,5	17/18	2,0/2,5	6+10	14/25	1	pce
1057173	20x1,9/2,0	20	1,9/2,0	6	14/25	1	pce
1057174	20x2,8	20	2,8	10	14/25	1	pce
1057175	25x2,3	25	2,3	6	14/25	1	pce
1057176	25x3,5	25	3,5	10	14/25	1	pce
1057177	32x2,9	32	2,9	6	14/25	1	pce

Uponor Q&E expansion tool spare battery M12



Item no.	Dimension	Qty 2	Qty 1	UOM
1061185	4Ah	12	1	pce

Uponor Expanding

Uponor Q&E expansion tool with heads M18 6bar



Item no.	Dimension	p bar	stroke mm	Qty 1	UOM
1063908	16/20/25/32	6	25	1	set

Uponor Q&E expansion tool with heads M18 10bar



Item no.	Dimension	p bar	stroke mm	Qty 1	UOM
1063909	16/20/25/H32	10	25	1	set

Uponor Q&E expansion head M18 H



Item no.	Dimension	d mm	s mm	p bar	stroke mm	Qty 1	UOM
1057182	32x2,9/4,4	32	2,9/4,4	6+10	25	1	pce
1057183	40x3,7	40	3,7	6	25	1	pce

Uponor Q&E expansion tool M18 VLD PEX



Item no.	Dimension	stroke mm	Qty 1	UOM
1085099	40-75	56	1	pce

Uponor Q&E expansion head VLD



Item no.	Dimension	d mm	s mm	p bar	stroke mm	Qty 1	UOM
1085095	40x3,7/5,5	40	3,7/5,5	6+10	56	1	pce
1085096	50x4,6/6,9	50	4,6/6,9	6+10	56	1	pce
1085097	63x5,8/8,6	63	5,8/8,6	6+10	56	1	pce
1085098	75x6,8/10,3	75	6,8/10,3	6+10	56	1	pce

Uponor Expanding

Uponor Q&E expansion tool battery M18 PEX



Item no.	Dimension	Qty 1	UOM
1085100	5,0Ah	1	pce

Uponor Q&E expansion tool charger M12/M18 PEX



Item no.	Dimension	OV V	Qty 1	UOM
1085101	220-240V/50-60Hz	230	1	pce

Uponor Q&E graphite paste, manual tools



Item no.	Dimension	Weight kg	Qty 1	UOM
1008334	30g	0,03	20	pce

Uponor Q&E graphite paste



Item no.	Dimension	Weight kg	Qty 1	UOM
1005017	100g	0,10	1	pce

Uponor Fixing

Uponor Siccus 14 PS cutter, groove

- thermal cutting tool for EPS
- 230V, 50/60Hz
- with tool to cut grooves for 14mm pipes



Item no.	Dimension	OV V	Qty 2	Qty 1	UOM
1006290	14mm	230V 230	20	1	pce

Uponor Tacker stapling tool

- full metal
- lightweight
- for max 125 clips

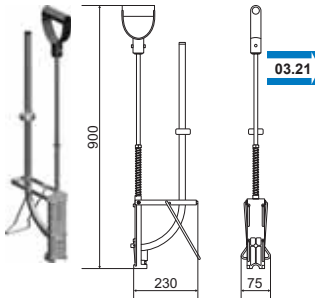

Item no.	Dimension	Qty 2	Qty 1	UOM
1119039	14-20mm	50	1	pce

Uponor Tacker clip stapler magazine

- Tacker tool
- for use with Uponor Tacker clips



03.21

Item no.	Dimension	Qty 2	Qty 1	UOM
1002295*	14-20mm l=700mm	32	1	pce

Uponor Multi UFHC roller manual

- or sticking down of insulation sections and edges, takes a roll of tape.



Item no.	Qty 2	Qty 1	UOM
1000142	20	1	pce

Uponor Multi tying tool

- For twisting of the tying wires while fixing the pipe on steel meshes.



Item no.	Qty 1	UOM
1034533*	1	pce

Uponor Others

Uponor Flex pipe in pipe replace tool PEX

- Used when replacing a damaged inner pipe in a conduit
- Suitable for Uponor PEX pipe in dimensions 15, 16 and 18 mm.



Item no.	Dimension	d mm	Qty 1	UOM
1089013	15-18	15-18	1	pce

Uponor Smart Aqua mounting rack bending tool

- For bending the 2 meter long mounting track.



Item no.	Dimension	Qty 2	Qty 1	UOM
1015424	2m	100	1	pce

uponor

Uponor GmbH
P.O. Box 1641
97433 Hassfurt
Germany

T +49-(0)9521 690 0
F +49-(0)9521 690 750
E international@uponor.com

03/2021



www.uponor.com